

Feed-through header - MCDNV 1,5/13-G1-3,5 RNP26THR - 1952704

Please be informed that the data shown in this PDF Document is generated from our Online Catalog. Please find the complete data in the user's documentation. Our General Terms of Use for Downloads are valid (<http://phoenixcontact.com/download>)



PCB headers, nominal current: 8 A, rated voltage (III/2): 160 V, nominal cross section: 1.5 mm², number of positions: 13, pitch: 3.5 mm, color: black, contact surface: Tin, mounting: THR soldering, pin layout: Linear pinning, solder pin [P]: 2.6 mm, Article with engagement nose. The pin length is 2.6 mm. User information and design recommendations on Through Hole Reflow Technology can be found at: "Downloads"

The figure shows a 10-pos. version with 20 contacts

Your advantages

- Designed for integration into the SMT soldering process
- Intuitive locking mechanism prevents accidental disconnection
- Vertical connection enables multi-row arrangement on the PCB



Key Commercial Data

Packing unit	40 pc
Minimum order quantity	40 pc
GTIN	
GTIN	4017918919917

Technical data

Dimensions

Length [l]	15.2 mm
Width	49.2 mm
Pitch	3.5 mm
Dimension a	42 mm
Width [w]	49.2 mm
Height [h]	15.9 mm
Installed height	13.3 mm
Length of the solder pin	2.6 mm
Pin dimensions	0.8 x 0.8 mm
Pin spacing	8.30 mm
Length	15.2 mm

Feed-through header - MCDNV 1,5/13-G1-3,5 RNP26THR - 1952704

Technical data

General

Range of articles	MCDNV 1,5/...-G1-RN-THR
Insulating material group	IIIa
Rated surge voltage (III/3)	2.5 kV
Rated surge voltage (III/2)	2.5 kV
Rated surge voltage (II/2)	2.5 kV
Rated voltage (III/3)	160 V
Rated voltage (III/2)	160 V
Rated voltage (II/2)	250 V
Connection in acc. with standard	EN-VDE
Nominal current I_N	8 A
Maximum load current	8 A (per position)
Insulating material	LCP
Flammability rating according to UL 94	V0
Color	black
Number of positions	13

General information

Type of note	Details for soldering processes
Note	Processing using reflow processes in compliance with IEC 60068-2-58 or DIN EN 61760-1 (latest version) Moisture Sensitive Level (MSL) = 1 according to IPC/JEDEC J-STD-020-C

Standards and Regulations

Connection in acc. with standard	EN-VDE
	CUL
Flammability rating according to UL 94	V0

Environmental Product Compliance

China RoHS	Environmentally friendly use period: unlimited = EFUP-e
	No hazardous substances above threshold values

Drawings

Feed-through header - MCDNV 1,5/13-G1-3,5 RNP26THR - 1952704

Drilling diagram

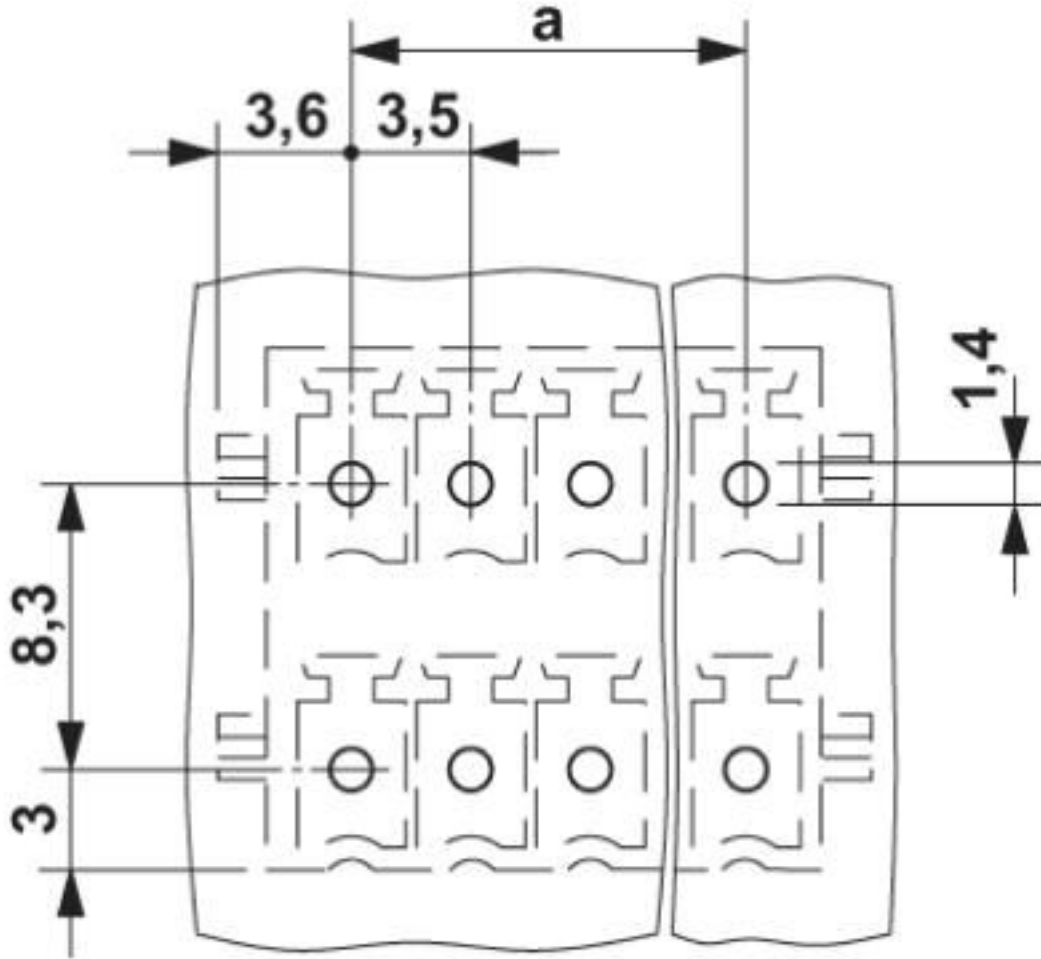

*) $\leq 8\text{-pos.} = 1.3$ / $> 8\text{-pos.} = 1.4$

Feed-through header - MCDNV 1,5/13-G1-3,5 RNP26THR - 1952704

Diagram

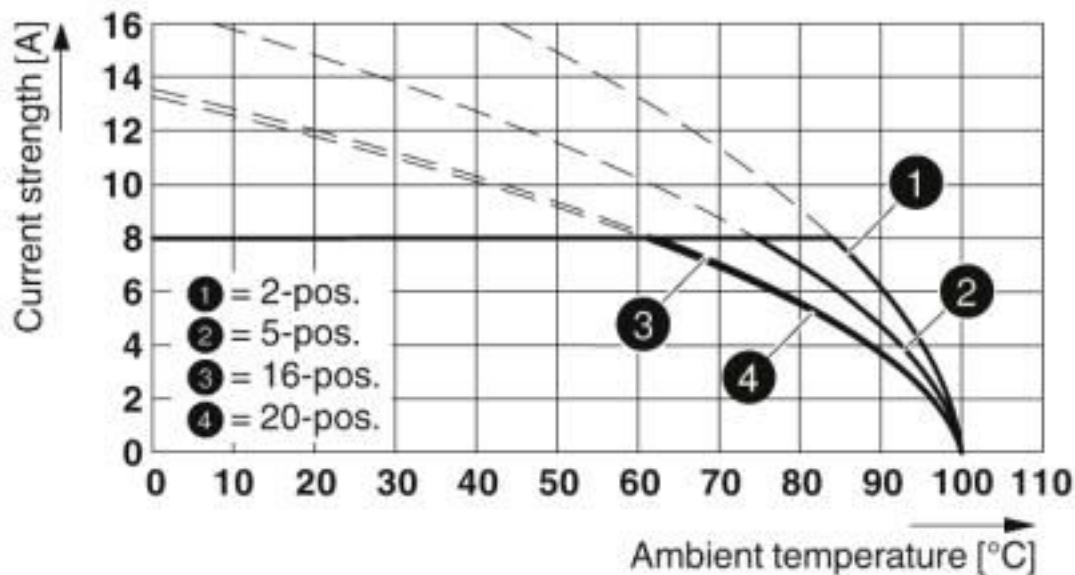

Type: FMC 1,5/...-ST-3,5-RF with MCDNV 1,5/...-G1-3,5 RNP...THR

Dimensional drawing

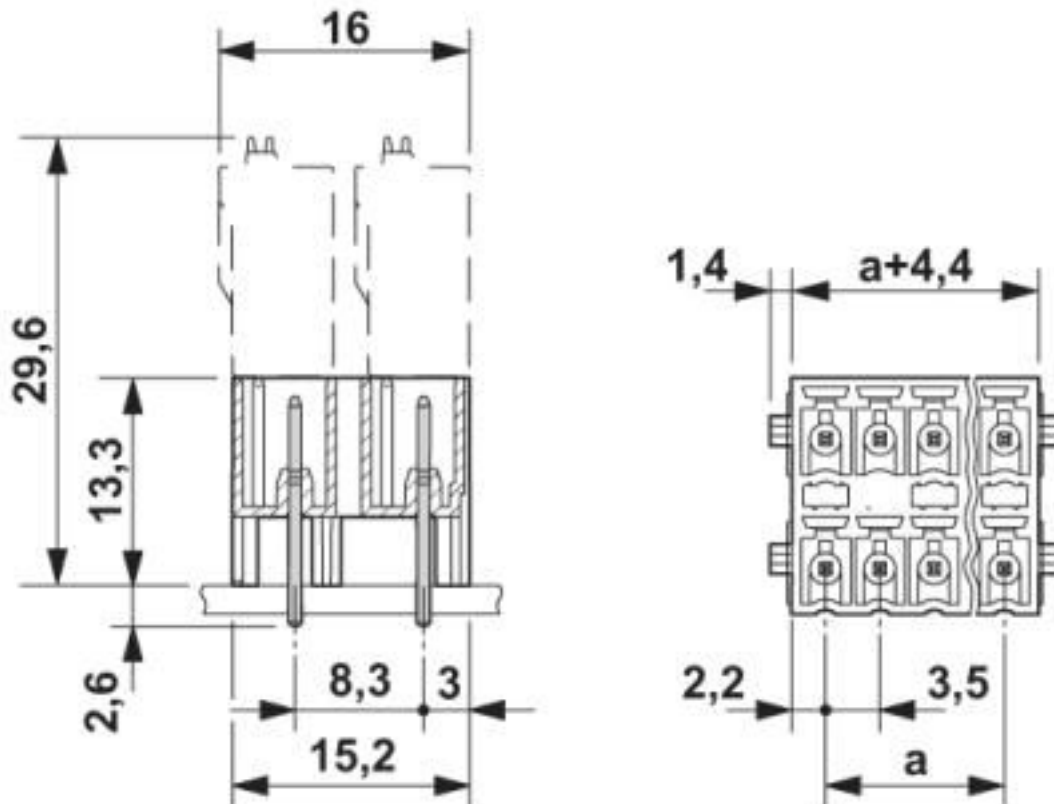

Feed-through header - MCDNV 1,5/13-G1-3,5 RNP26THR - 1952704

Classifications

eCl@ss

eCl@ss 10.0.1	27440402
eCl@ss 4.0	27260700
eCl@ss 4.1	27260700
eCl@ss 5.0	27260700
eCl@ss 5.1	27260700
eCl@ss 6.0	27260700
eCl@ss 7.0	27440402
eCl@ss 8.0	27440402
eCl@ss 9.0	27440402

ETIM

ETIM 3.0	EC001121
ETIM 4.0	EC002637
ETIM 5.0	EC002637
ETIM 6.0	EC002637
ETIM 7.0	EC002637

UNSPSC

UNSPSC 6.01	30211810
UNSPSC 7.0901	39121409
UNSPSC 11	39121409
UNSPSC 12.01	39121409
UNSPSC 13.2	39121409
UNSPSC 18.0	39121409
UNSPSC 19.0	39121409
UNSPSC 20.0	39121409
UNSPSC 21.0	39121409

Approvals

Approvals

Approvals

IECEE CB Scheme / VDE Gutachten mit Fertigungsüberwachung / EAC / cULus Recognized

Ex Approvals

Approval details

Feed-through header - MCDNV 1,5/13-G1-3,5 RNP26THR - 1952704

Approvals

IECEE CB Scheme		http://www.iecee.org/	DE1-60987-B1B2
Nominal voltage UN	160 V		
Nominal current IN	8 A		

VDE Gutachten mit Fertigungsüberwachung		http://www2.vde.com/de/Institut/Online-Service/VDE-gepruefteProdukte/Seiten/Online-Suche.aspx	40011723
Nominal voltage UN	160 V		
Nominal current IN	8 A		

EAC		B.01687
-----	--	---------

cULus Recognized		http://database.ul.com/cgi-bin/XYV/template/LISEXT/1FRAME/index.htm	E60425-20110128
	B	D	
Nominal voltage UN	150 V	150 V	
Nominal current IN	8 A	8 A	

Accessories

Accessories

Coding element

Coding profile - CP-MSTB - 1734634

Coding profile, is inserted into the slot on the plug or inverted header, red insulating material



Labeled terminal marker

Feed-through header - MCDNV 1,5/13-G1-3,5 RNP26THR - 1952704

Accessories

Marker card - SK 3,81/2,8:FORTL.ZAHLEN - 0804109



Marker card, Card, white, labeled, horizontal: consecutive numbers 1 ... 10, 11 ... 20, etc. up to 91 ... (99)100, mounting type: adhesive, for terminal block width: 3.81 mm, lettering field size: 3.81 x 2.8 mm

Phoenix Contact 2020 © - all rights reserved
<http://www.phoenixcontact.com>

PHOENIX CONTACT GmbH & Co. KG
Flachsmarktstr. 8
32825 Blomberg
Germany
Tel. +49 5235 300
Fax +49 5235 3 41200
<http://www.phoenixcontact.com>

X-ON Electronics

Largest Supplier of Electrical and Electronic Components

Click to view similar products for [Pluggable Terminal Blocks](#) category:

Click to view products by [Phoenix Contact](#) manufacturer:

Other Similar products are found below :

[57.510.0053](#) [MC 1.5/ 6-ST-3.5 GY AU](#) [734-104](#) [734-302](#) [8-141-P](#) [8426620000](#) [860505](#) [860810](#) [GBPACX-12](#) [93.731.4953.0](#) [PV05-5,08-K](#)
[PVP02-5,00](#) [PVP03-3,50](#) [PVP04-3,50](#) [PVS02-5,00](#) [1-1986160-3](#) [1377680000](#) [1531000000](#) [1546228-5](#) [ELFH16150](#) [ELFP03110](#)
[ELFP10210](#) [ELFT06250](#) [ELVP03100](#) [1700101](#) [1700410](#) [1700425](#) [1702246](#) [1705229](#) [1710175](#) [1714537](#) [1717806](#) [1719600](#) [1728941](#)
[1734692](#) [1734795](#) [1736036](#) [1740194](#) [1740291](#) [1740628](#) [1740990](#) [1746952](#) [1750207](#) [1752441](#) [1752865](#) [1754115](#) [1754144](#) [1756913](#)
[1760051](#) [1760336](#)