

Printed-circuit board connector - MCDNV 1,5/19-G1-3,5 P14THR - 1953185

Please be informed that the data shown in this PDF Document is generated from our Online Catalog. Please find the complete data in the user's documentation. Our General Terms of Use for Downloads are valid (<http://phoenixcontact.com/download>)



PCB headers, nominal current: 8 A, rated voltage (III/2): 160 V, nominal cross section: 1.5 mm², number of positions: 19, pitch: 3.5 mm, color: black, contact surface: Tin, mounting: THR soldering, pin layout: Linear pinning, solder pin [P]: 1.4 mm, The pin length is 1.4 mm. User information and design recommendations on Through Hole Reflow Technology can be found at: Downloads".

The figure shows a 10-pos. version with 20 contacts

Your advantages

- Designed for integration into the SMT soldering process
- Vertical connection enables multi-row arrangement on the PCB
- Maximum flexibility when it comes to device design – one header for connectors with different connection technologies
- Conductor connection on several levels enables higher contact density



Key Commercial Data

Packing unit	30 pc
Minimum order quantity	30 pc
GTIN	 4 017918 920340
GTIN	4017918920340

Technical data

Dimensions

Length [l]	15.2 mm
Width	68 mm
Pitch	3.5 mm
Dimension a	63 mm
Width [w]	68 mm
Height [h]	14.7 mm
Installed height	13.3 mm
Length of the solder pin	1.4 mm
Pin dimensions	0.8 x 0.8 mm

Printed-circuit board connector - MCDNV 1,5/19-G1-3,5 P14THR - 1953185

Technical data

Dimensions

Pin spacing	8.30 mm
Length	15.2 mm

General

Range of articles	MCDNV 1,5/..-G1-THR
Insulating material group	IIIa
Rated surge voltage (III/3)	2.5 kV
Rated surge voltage (III/2)	2.5 kV
Rated surge voltage (II/2)	2.5 kV
Rated voltage (III/3)	160 V
Rated voltage (III/2)	160 V
Rated voltage (II/2)	250 V
Connection in acc. with standard	EN-VDE
Nominal current I_N	8 A
Maximum load current	8 A (per position)
Insulating material	LCP
Flammability rating according to UL 94	V0
Color	black
Number of positions	19

Standards and Regulations

Connection in acc. with standard	EN-VDE
	CUL
Flammability rating according to UL 94	V0

Environmental Product Compliance

China RoHS	Environmentally friendly use period: unlimited = EFUP-e
	No hazardous substances above threshold values

Drawings

Printed-circuit board connector - MCDNV 1,5/19-G1-3,5 P14THR - 1953185

Drilling diagram

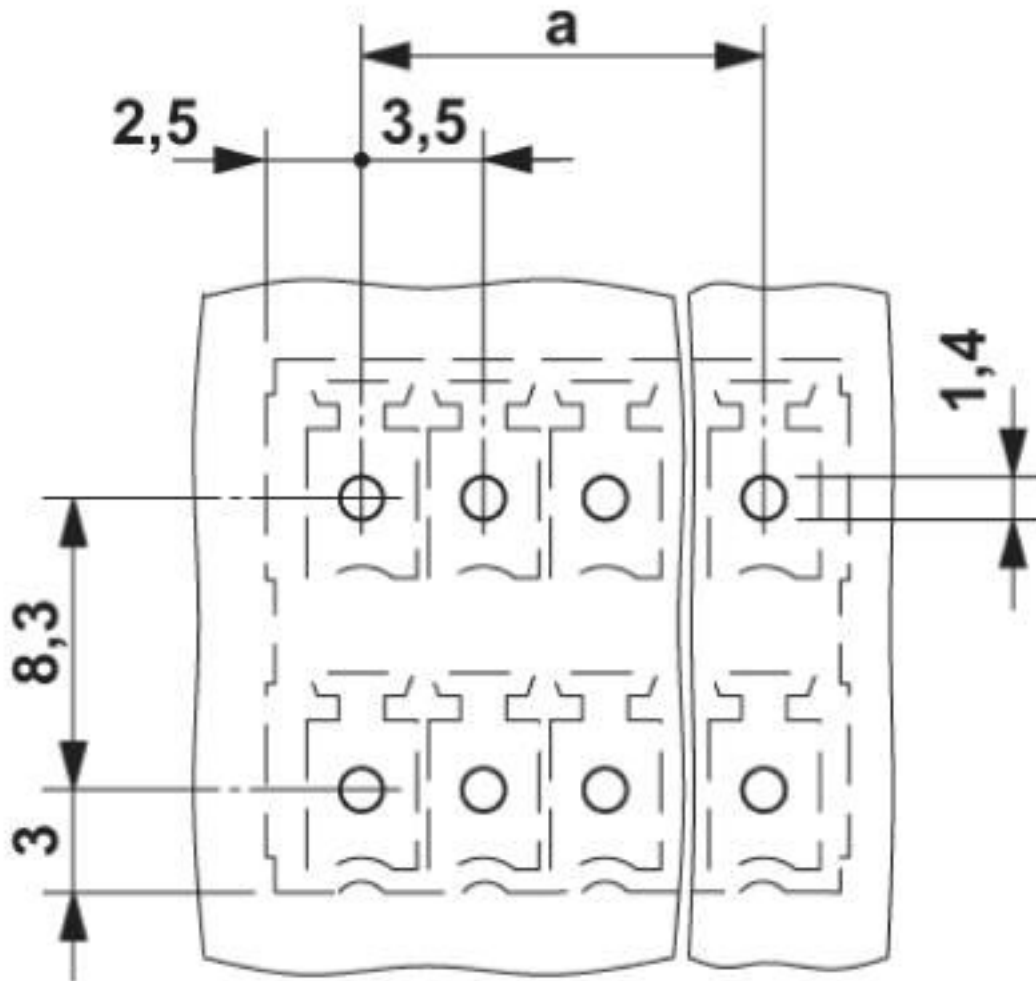

*) $\leq 8\text{-pos.} = 1.3 / > 8\text{-pos.} = 1.4$

Printed-circuit board connector - MCDNV 1,5/19-G1-3,5 P14THR - 1953185

Diagram

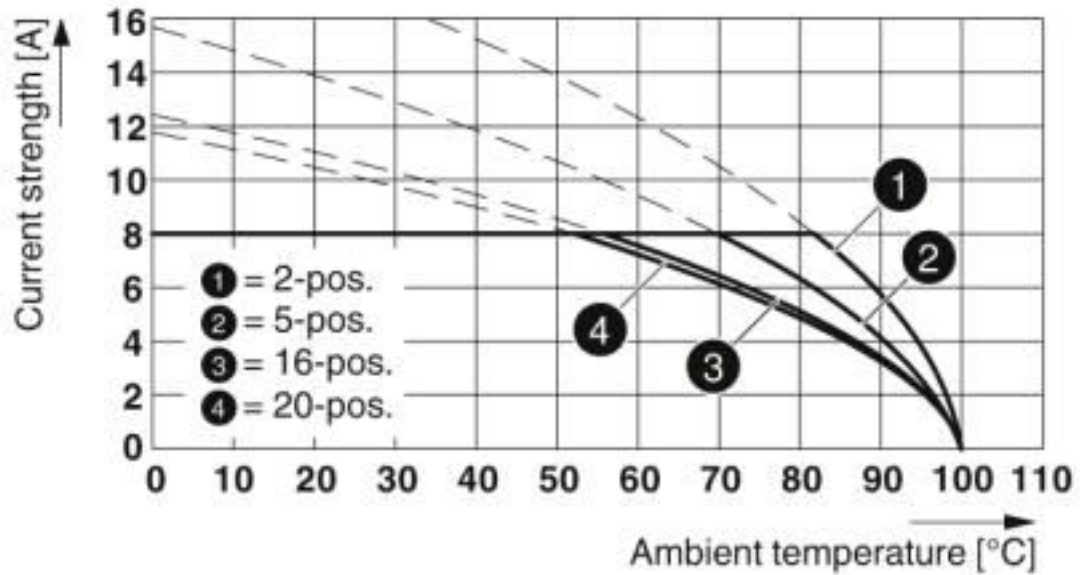

Typ: FMC 1,5/...-ST-3,5 with MCDNV 1,5/...-G1-3,5 P...THR

Diagram

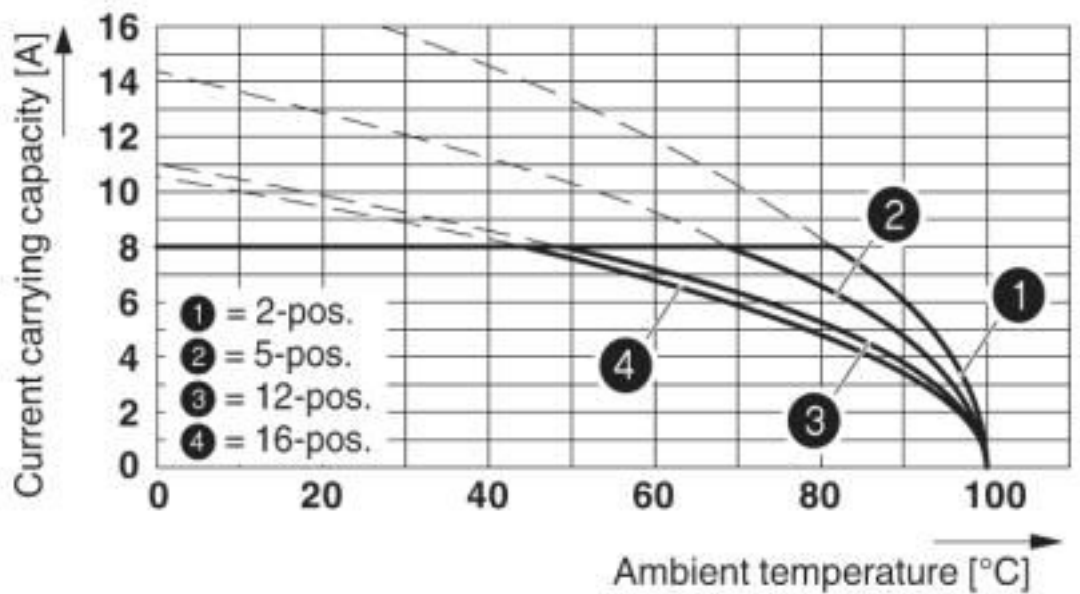

Typ: FMCD 1,5/...-ST-3,5 with MCDNV 1,5/...-G1-3,5 P...THR

Printed-circuit board connector - MCDNV 1,5/19-G1-3,5 P14THR - 1953185

Dimensional drawing

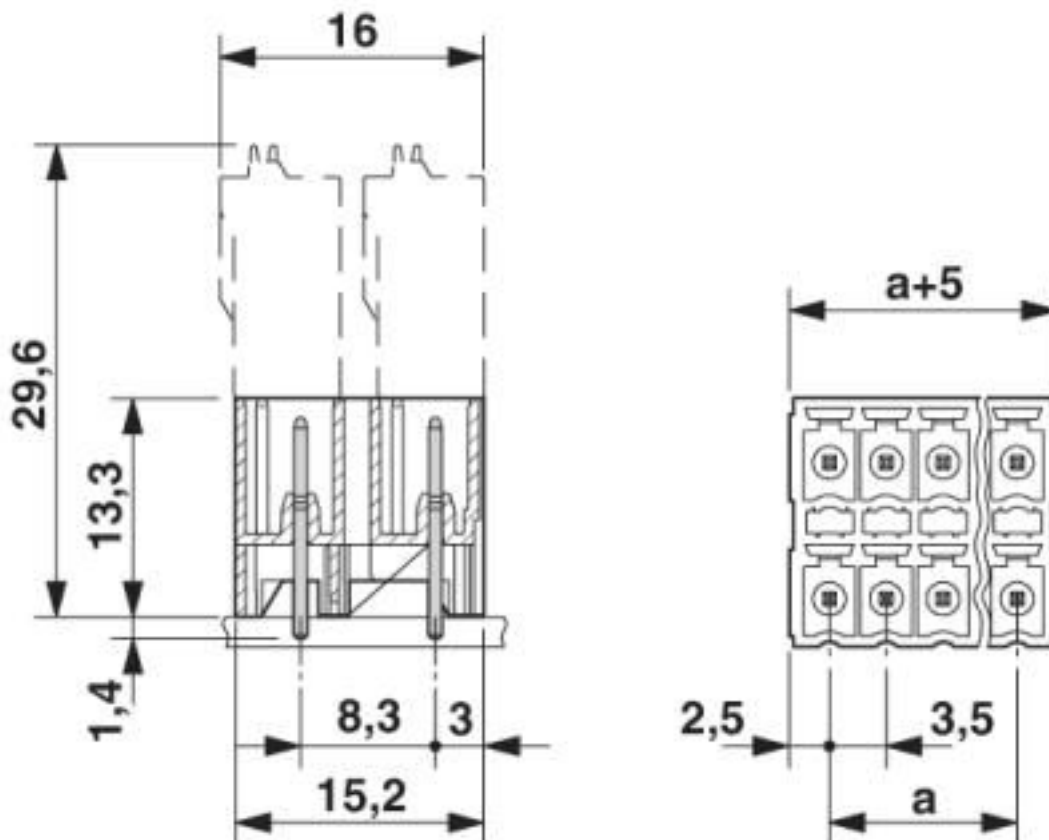

Classifications

eCl@ss

eCl@ss 10.0.1	27440402
eCl@ss 4.0	27260700
eCl@ss 4.1	27260700
eCl@ss 5.0	27260700
eCl@ss 5.1	27260700
eCl@ss 6.0	27260700
eCl@ss 7.0	27440402
eCl@ss 8.0	27440402
eCl@ss 9.0	27440402

ETIM

ETIM 3.0	EC001121
ETIM 4.0	EC002637
ETIM 5.0	EC002637
ETIM 6.0	EC002637

Printed-circuit board connector - MCDNV 1,5/19-G1-3,5 P14THR - 1953185

Classifications

ETIM

ETIM 7.0	EC002637
----------	----------

UNSPSC

UNSPSC 6.01	30211810
UNSPSC 7.0901	39121409
UNSPSC 11	39121409
UNSPSC 12.01	39121409
UNSPSC 13.2	39121409
UNSPSC 18.0	39121409
UNSPSC 19.0	39121409
UNSPSC 20.0	39121409
UNSPSC 21.0	39121409

Approvals

Approvals

Approvals

IECEE CB Scheme / VDE Gutachten mit Fertigungsüberwachung / EAC / cULus Recognized

Ex Approvals

Approval details

IECEE CB Scheme		http://www.iecee.org/	DE1-60987-B1B2
Nominal voltage UN	160 V		
Nominal current IN	8 A		

VDE Gutachten mit Fertigungsüberwachung		http://www2.vde.com/de/Institut/Online-Service/VDE-gepruefteProdukte/Seiten/Online-Suche.aspx	40011723
Nominal voltage UN	160 V		
Nominal current IN	8 A		

Printed-circuit board connector - MCDNV 1,5/19-G1-3,5 P14THR - 1953185

Approvals

EAC		B.01687
-----	--	---------

cULus Recognized		http://database.ul.com/cgi-bin/XYV/template/LISEXT/1FRAME/index.htm	E60425-20110128
	B	D	
Nominal voltage UN	150 V	150 V	
Nominal current IN	8 A	8 A	

Accessories

Accessories

Coding element

Coding profile - CP-MSTB - 1734634

Coding profile, is inserted into the slot on the plug or inverted header, red insulating material



Labeled terminal marker

Marker card - SK 3,81/2,8:FORTL.ZAHLEN - 0804109



Marker card, Card, white, labeled, horizontal: consecutive numbers 1 ... 10, 11 ... 20, etc. up to 91 ... (99)100, mounting type: adhesive, for terminal block width: 3.81 mm, lettering field size: 3.81 x 2.8 mm

Additional products

Printed-circuit board connector - FMC 1,5/19-ST-3,5 - 1952432



PCB connector, nominal current: 8 A, rated voltage (III/2): 160 V, nominal cross section: 1.5 mm², number of positions: 19, pitch: 3.5 mm, connection method: Push-in spring connection, color: green, contact surface: Tin

Phoenix Contact 2020 © - all rights reserved
<http://www.phoenixcontact.com>

PHOENIX CONTACT GmbH & Co. KG
Flachmarktstr. 8
32825 Blomberg
Germany
Tel. +49 5235 300
Fax +49 5235 3 41200
<http://www.phoenixcontact.com>

X-ON Electronics

Largest Supplier of Electrical and Electronic Components

Click to view similar products for [Pluggable Terminal Blocks](#) category:

Click to view products by [Phoenix Contact](#) manufacturer:

Other Similar products are found below :

[57.510.0053](#) [MC 1.5/ 6-ST-3.5 GY AU](#) [734-104](#) [734-302](#) [8-141-P](#) [8426620000](#) [860505](#) [860810](#) [GBPACX-12](#) [93.731.4953.0](#) [PV05-5,08-K](#)
[PVP02-5,00](#) [PVP03-3,50](#) [PVP04-3,50](#) [PVS02-5,00](#) [1-1986160-3](#) [1377680000](#) [1531000000](#) [1546228-5](#) [ELFH16150](#) [ELFP03110](#)
[ELFP10210](#) [ELFT06250](#) [ELVP03100](#) [1700101](#) [1700410](#) [1700425](#) [1702246](#) [1705229](#) [1710175](#) [1714537](#) [1717806](#) [1719600](#) [1728941](#)
[1734692](#) [1734795](#) [1736036](#) [1740194](#) [1740291](#) [1740628](#) [1740990](#) [1746952](#) [1750207](#) [1752441](#) [1752865](#) [1754115](#) [1754144](#) [1756913](#)
[1760051](#) [1760336](#)