

Printed-circuit board connector - CC 2,5/ 4-G-5,08 P26THR - 1954401

Please be informed that the data shown in this PDF Document is generated from our Online Catalog. Please find the complete data in the user's documentation. Our General Terms of Use for Downloads are valid (<http://phoenixcontact.com/download>)

PCB headers, nominal current: 12 A, rated voltage (III/2): 320 V, nominal cross section: 2.5 mm², number of positions: 4, pitch: 5.08 mm, color: black, contact surface: Tin, mounting: THR soldering, pin layout: Linear pinning, solder pin [P]: 2.6 mm, User information and design recommendations for through hole reflow technology can be found under: Downloads



The figure shows a 10-position version of the product

Your advantages

- Designed for integration into the SMT soldering process
- Maximum flexibility when it comes to device design – one header for connectors with different connection technologies

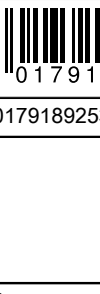

Key Commercial Data

Packing unit	50 pc
GTIN	 4 017918 925314
GTIN	4017918925314

Technical data

Dimensions

Length [l]	12 mm
Width	19.92 mm
Pitch	5.08 mm
Dimension a	15.24 mm
Width [w]	19.92 mm
Height [h]	11.2 mm
Installed height	8.6 mm
Length of the solder pin	2.6 mm
Pin dimensions	1 x 1 mm
Length	12 mm

General

Range of articles	CC 2,5/..-G
-------------------	-------------

Printed-circuit board connector - CC 2,5/ 4-G-5,08 P26THR - 1954401

Technical data

General

Insulating material group	IIIa
Rated surge voltage (III/3)	4 kV
Rated surge voltage (III/2)	4 kV
Rated surge voltage (II/2)	4 kV
Rated voltage (III/3)	250 V
Rated voltage (III/2)	320 V
Rated voltage (II/2)	400 V
Connection in acc. with standard	EN-VDE
Nominal current I _N	12 A
Maximum load current	12 A (per position)
Insulating material	LCP
Flammability rating according to UL 94	V0
Color	black
Number of positions	4

General information

Type of note	Details for soldering processes
Note	Processing using reflow processes in compliance with IEC 60068-2-58 or DIN EN 61760-1 (latest version) Moisture Sensitive Level (MSL) = 1 according to IPC/JEDEC J-STD-020-C

Standards and Regulations

Connection in acc. with standard	EN-VDE
	CUL
Flammability rating according to UL 94	V0

Environmental Product Compliance

China RoHS	Environmentally friendly use period: unlimited = EFUP-e
	No hazardous substances above threshold values

Drawings

Printed-circuit board connector - CC 2,5/ 4-G-5,08 P26THR - 1954401

Drilling diagram

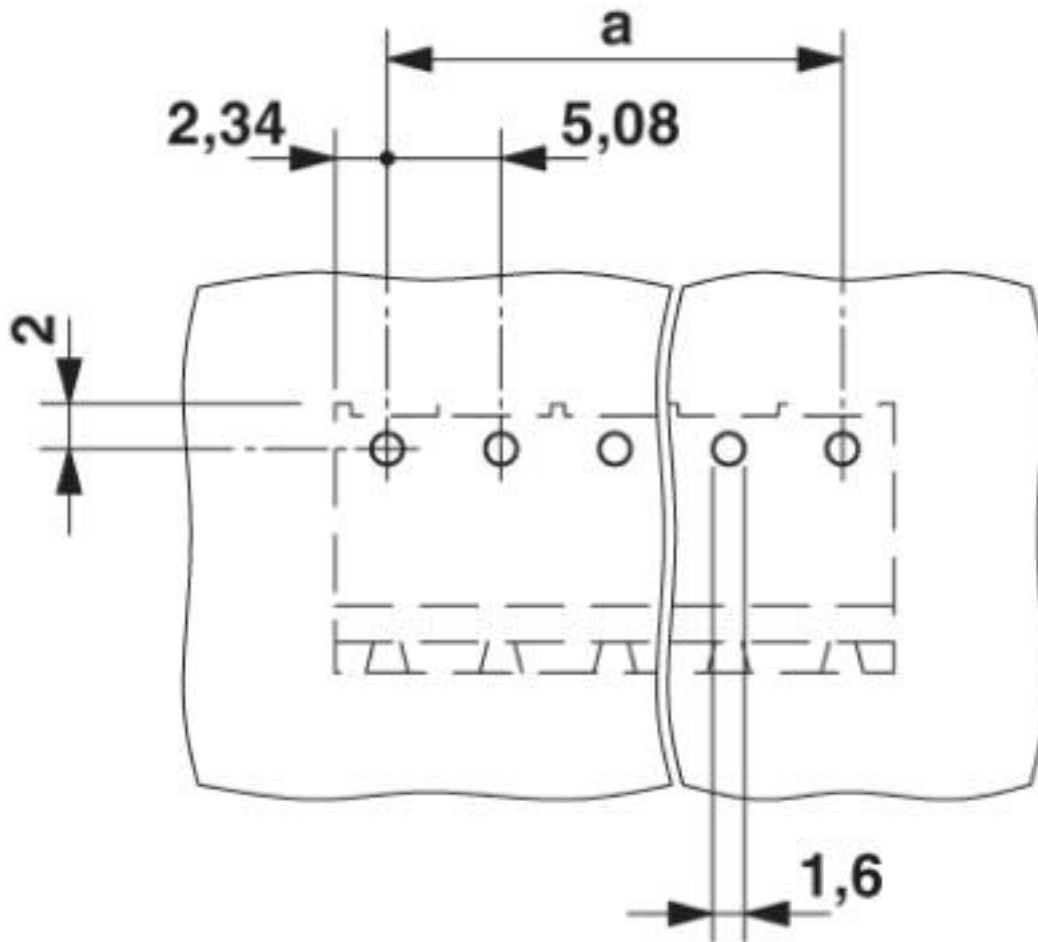

Printed-circuit board connector - CC 2,5/ 4-G-5,08 P26THR - 1954401

Diagram

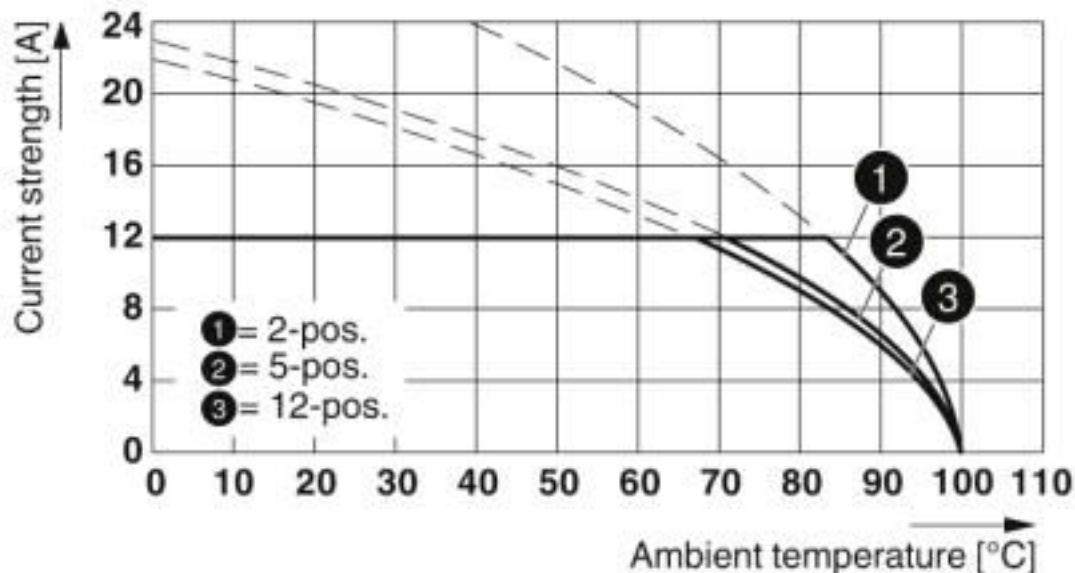

Type: MSTB 2,5/...-ST-5,08 with CC 2,5/...-G-5,08 P26THR

Classifications

eCl@ss

eCl@ss 10.0.1	27440402
eCl@ss 4.0	27260700
eCl@ss 4.1	27260700
eCl@ss 5.0	27260700
eCl@ss 5.1	27260700
eCl@ss 6.0	27260700
eCl@ss 7.0	27440402
eCl@ss 8.0	27440402
eCl@ss 9.0	27440402

ETIM

ETIM 3.0	EC001121
ETIM 4.0	EC002637
ETIM 5.0	EC002637
ETIM 6.0	EC002637
ETIM 7.0	EC002637

UNSPSC

UNSPSC 6.01	30211810
UNSPSC 7.0901	39121409
UNSPSC 11	39121409
UNSPSC 12.01	39121409

Printed-circuit board connector - CC 2,5/ 4-G-5,08 P26THR - 1954401

Classifications

UNSPSC

UNSPSC 13.2	39121409
UNSPSC 18.0	39121409
UNSPSC 19.0	39121409
UNSPSC 20.0	39121409
UNSPSC 21.0	39121409

Approvals

Approvals

Approvals

IECEE CB Scheme / VDE Gutachten mit Fertigungsüberwachung / EAC / cULus Recognized

Ex Approvals

Approval details

IECEE CB Scheme		http://www.iecee.org/	DE1-58421-B1B2
Nominal voltage UN	400 V		
Nominal current IN	12 A		

VDE Gutachten mit Fertigungsüberwachung		http://www2.vde.com/de/Institut/Online-Service/VDE-gepruefteProdukte/Seiten/Online-Suche.aspx	40041286
Nominal voltage UN	400 V		
Nominal current IN	12 A		

EAC		B.01687
-----	--	---------

cULus Recognized		http://database.ul.com/cgi-bin/XYVV/template/LISEXT/1FRAME/index.htm	E60425-19931011
Nominal voltage UN	B	D	
	300 V	300 V	

Printed-circuit board connector - CC 2,5/ 4-G-5,08 P26THR - 1954401

Approvals

	B	D
Nominal current I _N	16 A	10 A

Accessories

Accessories

Coding element

Coding section - CR-MSTB - 1734401



Coding section, inserted into the recess in the header or the inverted plug, red insulating material

Coding section - CR-MSTB NAT HT - 1954362



HT coding section, prior to the reflow soldering process it is inserted into the recess on the header, made from high-temperature-resistant beige insulation material

Labeled terminal marker

Marker card - SK 5,08/3,8:FORTL.ZAHLEN - 0804293



Marker card, Card, white, labeled, horizontal: consecutive numbers 1 ... 10, 11 ... 20, etc. up to 91 ... (99)100, mounting type: adhesive, for terminal block width: 5.08 mm, lettering field size: 5.08 x 3.8 mm

Marker pen

Marker pen - B-STIFT - 1051993



Marker pen, for manual labeling of unprinted Zack strips, smear-proof and waterproof, line thickness 0.5 mm

Terminal marking

Printed-circuit board connector - CC 2,5/ 4-G-5,08 P26THR - 1954401

Accessories

Marker card - SK 5,08/3,8:UNBEDRUCKT - 0805412



Marker card, Card, white, unlabeled, can be labeled with: Marker pen, mounting type: adhesive, for terminal block width: 5.08 mm, lettering field size: 5.08 x 3.8 mm

Additional products

Printed-circuit board connector - TVMSTB 2,5/ 4-ST-5,08 - 1719024



PCB connector, nominal current: 12 A, rated voltage (III/2): 400 V, nominal cross section: 2.5 mm², number of positions: 4, pitch: 5.08 mm, connection method: Screw connection with tension sleeve, color: green, contact surface: Tin

Printed-circuit board connector - FKCN 2,5/ 4-ST-5,08 - 1754584



PCB connector, nominal current: 12 A, rated voltage (III/2): 320 V, nominal cross section: 2.5 mm², number of positions: 4, pitch: 5.08 mm, connection method: Push-in spring connection, color: green, contact surface: Tin

Printed-circuit board connector - MSTB 2,5/ 4-ST-5,08 - 1757035



PCB connector, nominal current: 12 A, rated voltage (III/2): 320 V, nominal cross section: 2.5 mm², number of positions: 4, pitch: 5.08 mm, connection method: Screw connection with tension sleeve, color: green, contact surface: Tin

Printed-circuit board connector - MSTBP 2,5/ 4-ST-5,08 - 1769036



PCB connector, nominal current: 12 A, rated voltage (III/2): 320 V, nominal cross section: 2.5 mm², number of positions: 4, pitch: 5.08 mm, connection method: Screw connection with tension sleeve, color: green, contact surface: Tin

Printed-circuit board connector - CC 2,5/ 4-G-5,08 P26THR - 1954401

Accessories

Printed-circuit board connector - MSTB 2,5/ 4-STZ-5,08 - 1776155



PCB connector, nominal current: 12 A, rated voltage (III/2): 320 V, nominal cross section: 2.5 mm², number of positions: 4, pitch: 5.08 mm, connection method: Screw connection with tension sleeve, color: green, contact surface: Tin

Printed-circuit board connector - FRONT-MSTB 2,5/ 4-ST-5,08 - 1777303



PCB connector, nominal current: 12 A, rated voltage (III/2): 320 V, nominal cross section: 2.5 mm², number of positions: 4, pitch: 5.08 mm, connection method: Front screw connection, color: green, contact surface: Tin

Printed-circuit board connector - MSTBT 2,5/ 4-ST-5,08 - 1780002



PCB connector, nominal current: 12 A, rated voltage (III/2): 320 V, nominal cross section: 2.5 mm², number of positions: 4, pitch: 5.08 mm, connection method: Screw connection with tension sleeve, color: green, contact surface: Tin

Printed-circuit board connector - MVSTBR 2,5/ 4-ST-5,08 - 1792265



PCB connector, nominal current: 12 A, rated voltage (III/2): 320 V, nominal cross section: 2.5 mm², number of positions: 4, pitch: 5.08 mm, connection method: Screw connection with tension sleeve, color: green, contact surface: Tin

Printed-circuit board connector - MVSTBW 2,5/ 4-ST-5,08 - 1792773



PCB connector, nominal current: 12 A, rated voltage (III/2): 320 V, nominal cross section: 2.5 mm², number of positions: 4, pitch: 5.08 mm, connection method: Screw connection with tension sleeve, color: green, contact surface: Tin

Printed-circuit board connector - CC 2,5/ 4-G-5,08 P26THR - 1954401

Accessories

Printed-circuit board connector - MSTBC 2,5/ 4-ST-5,08 - 1808832



PCB connector, nominal current: 12 A, rated voltage (III/2): 320 V, nominal cross section: 2.5 mm², number of positions: 4, pitch: 5.08 mm, connection method: Crimp connection, color: green, Corresponding female crimp contacts with current [A] and conductor cross section range [mm²] data: 10A/MSTBC-MT 0,5-1,0 (3190564); 10A/MSTBC-MT 0,5-1,0 BA (3190645); 12A/MSTBC-MT 1,5-2,5 (3190551); 12A/MSTBC-MT 1,5-2,5 BA (3190658). BA = Bandkontakte

Printed-circuit board connector - MSTBC 2,5/ 4-STZ-5,08 - 1809527



PCB connector, nominal current: 12 A, rated voltage (III/2): 320 V, nominal cross section: 2.5 mm², number of positions: 4, pitch: 5.08 mm, connection method: Crimp connection, color: green, Corresponding female crimp contacts with current [A] and conductor cross section range [mm²] data: 10A/MSTBC-MT 0,5-1,0 (3190564); 10A/MSTBC-MT 0,5-1,0 BA (3190645); 12A/MSTBC-MT 1,5-2,5 (3190551); 12A/MSTBC-MT 1,5-2,5 BA (3190658). BA = Bandkontakte

Printed-circuit board connector - MSTBU 2,5/ 4-STD-5,08 - 1824146



Direct plug-in block, nominal current: 12 A, rated voltage (III/2): 320 V, nominal cross section: 2.5 mm², number of positions: 4, pitch: 5.08 mm, connection method: Screw connection with tension sleeve, color: green, contact surface: Tin, mounting: Direct mounting

Printed-circuit board connector - MSTBU 2,5/ 4-ST-5,08-FL - 1824379



Direct plug-in block, nominal current: 12 A, rated voltage (III/2): 320 V, nominal cross section: 2.5 mm², number of positions: 4, pitch: 5.08 mm, connection method: Screw connection with tension sleeve, color: green, contact surface: Tin, mounting: Direct mounting

Printed-circuit board connector - SMSTB 2,5/ 4-ST-5,08 - 1826306



PCB connector, nominal current: 12 A, rated voltage (III/2): 320 V, nominal cross section: 2.5 mm², number of positions: 4, pitch: 5.08 mm, connection method: Screw connection with tension sleeve, color: green, contact surface: Tin

Printed-circuit board connector - CC 2,5/ 4-G-5,08 P26THR - 1954401

Accessories

Printed-circuit board connector - TMSTBP 2,5/ 4-ST-5,08 - 1853036



PCB connector, nominal current: 12 A, rated voltage (III/2): 320 V, nominal cross section: 2.5 mm², number of positions: 4, pitch: 5.08 mm, connection method: Screw connection with tension sleeve, color: green, contact surface: Tin, The plug allows conductors to be looped through from module to module.

Printed-circuit board connector - FKC 2,5/ 4-ST-5,08 - 1873074



PCB connector, nominal current: 12 A, rated voltage (III/2): 320 V, nominal cross section: 2.5 mm², number of positions: 4, pitch: 5.08 mm, connection method: Push-in spring connection, color: green, contact surface: Tin

Printed-circuit board connector - FKCVW 2,5/ 4-ST-5,08 - 1873676



PCB connector, nominal current: 12 A, rated voltage (III/2): 320 V, nominal cross section: 2.5 mm², number of positions: 4, pitch: 5.08 mm, connection method: Push-in spring connection, color: green, contact surface: Tin

Printed-circuit board connector - FKCVR 2,5/ 4-ST-5,08 - 1873977



PCB connector, nominal current: 12 A, rated voltage (III/2): 320 V, nominal cross section: 2.5 mm², number of positions: 4, pitch: 5.08 mm, connection method: Push-in spring connection, color: green, contact surface: Tin

Printed-circuit board connector - QC 1/ 4-ST-5,08 - 1883271



PCB connector, nominal current: 10 A, rated voltage (III/2): 630 V, nominal cross section: 1 mm², number of positions: 4, pitch: 5.08 mm, connection method: Displacement connection, color: green, contact surface: Tin

Printed-circuit board connector - CC 2,5/ 4-G-5,08 P26THR - 1954401

Accessories

Printed-circuit board connector - FKCT 2,5/ 4-ST-5,08 - 1902136



PCB connector, nominal current: 12 A, rated voltage (III/2): 320 V, nominal cross section: 2.5 mm², number of positions: 4, pitch: 5.08 mm, connection method: Push-in spring connection, color: green, contact surface: Tin

Printed-circuit board connector - TFKC 2,5/ 4-ST-5,08 - 1962626



PCB connector, nominal current: 12 A, rated voltage (III/2): 320 V, nominal cross section: 2.5 mm², number of positions: 4, pitch: 5.08 mm, connection method: Push-in spring connection, color: green, contact surface: Tin

Printed-circuit board connector - FKCS 2,5/ 4-ST-5,08 - 1975095



PCB connector, nominal current: 12 A, rated voltage (III/2): 320 V, nominal cross section: 2.5 mm², number of positions: 4, pitch: 5.08 mm, connection method: Push-in spring connection, color: green, contact surface: Tin

Phoenix Contact 2020 © - all rights reserved
<http://www.phoenixcontact.com>

PHOENIX CONTACT GmbH & Co. KG
Flachsmarktstr. 8
32825 Blomberg
Germany
Tel. +49 5235 300
Fax +49 5235 3 41200
<http://www.phoenixcontact.com>

X-ON Electronics

Largest Supplier of Electrical and Electronic Components

Click to view similar products for [Pluggable Terminal Blocks](#) category:

Click to view products by [Phoenix Contact](#) manufacturer:

Other Similar products are found below :

[57.510.0053](#) [MC 1.5/ 6-ST-3.5 GY AU](#) [734-104](#) [734-302](#) [8-141-P](#) [8426620000](#) [860505](#) [860810](#) [GBPACX-12](#) [93.731.4953.0](#) [PV05-5,08-K](#)
[PVP02-5,00](#) [PVP03-3,50](#) [PVP04-3,50](#) [PVS02-5,00](#) [1-1986160-3](#) [1377680000](#) [1531000000](#) [1546228-5](#) [ELFH16150](#) [ELFP03110](#)
[ELFP10210](#) [ELFT06250](#) [ELVP03100](#) [1700101](#) [1700410](#) [1700425](#) [1702246](#) [1705229](#) [1710175](#) [1714537](#) [1717806](#) [1719600](#) [1728941](#)
[1734692](#) [1734795](#) [1736036](#) [1740194](#) [1740291](#) [1740628](#) [1740990](#) [1746952](#) [1750207](#) [1752441](#) [1752865](#) [1754115](#) [1754144](#) [1756913](#)
[1760051](#) [1760336](#)