

Printed-circuit board connector - PC 16/ 4-STF-10,16 - 1967472

Please be informed that the data shown in this PDF Document is generated from our Online Catalog. Please find the complete data in the user's documentation. Our General Terms of Use for Downloads are valid (<http://phoenixcontact.com/download>)

PCB connector, nominal current: 76 A, rated voltage (III/2): 1000 V, nominal cross section: 16 mm², number of positions: 4, pitch: 10.16 mm, connection method: Screw connection with tension sleeve, color: green, contact surface: Silver



The figure shows a 5-pos. version of the product

Your advantages

- Well-known connection principle allows worldwide use
- Low temperature rise, thanks to maximum contact force
- Allows connection of two conductors
- Integrated double steel spring provides additional safety in the event of temperature and power fluctuations
- Screwable flange for superior mechanical stability
- Integrated protective guide prevents incorrect insertion of the conductor underneath the tension sleeve

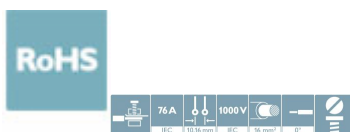

Key Commercial Data

Packing unit	25 pc
Minimum order quantity	25 pc
GTIN	
GTIN	4017918939335

Technical data

Item properties

Brief article description	Printed-circuit board connector
Plug-in system	POWER COMBICON 16
Type of contact	Female connector
Range of articles	PC 16/...-STF
Pitch	10.16 mm
Number of positions	4
Connection method	Screw connection with tension sleeve
Drive form screw head	Slotted (L)

Printed-circuit board connector - PC 16/ 4-STF-10,16 - 1967472

Technical data

Item properties

Screw thread	M4
Locking	Screw flange
Number of levels	1
Number of connections	4
Number of potentials	4

Electrical parameters

Nominal current	76 A
Nom. voltage	1000 V
Rated voltage	1000 V
Rated voltage (III/2)	1000 V
Rated voltage (II/2)	1000 V
Rated surge voltage (III/3)	8 kV
Rated surge voltage (III/2)	8 kV
Rated surge voltage (II/2)	6 kV

Connection capacity

Connection method	Screw connection with tension sleeve
pluggable	Yes
Conductor cross section solid	0.75 mm ² ... 16 mm ²
Conductor cross section flexible	0.75 mm ² ... 16 mm ²
Conductor cross section AWG / kcmil	18 ... 6
Conductor cross section flexible, with ferrule without plastic sleeve	0.5 mm ² ... 16 mm ² (Only in connection with CRIMPFOX 16 S)
Conductor cross section, flexible, with ferrule, with plastic sleeve	0.5 mm ² ... 10 mm ² (Only in connection with CRIMPFOX 16 S)
2 conductors with same cross section, solid	0.75 mm ² ... 6 mm ²
2 conductors with same cross section, flexible	0.75 mm ² ... 6 mm ²
2 conductors with same cross section, flexible, with ferrule without plastic sleeve	0.5 mm ² ... 4 mm ²
2 conductors with the same cross section, flexible, with TWIN ferrule with plastic sleeve	0.5 mm ² ... 6 mm ²
Cylindrical gauge a x b / diameter	- / 5.4 mm
Stripping length	12 mm
Torque	1.7 Nm ... 1.8 Nm

Flange specifications

Type of locking	Screw locking
Mounting flange	Screw flange

Material data - contact

Note	WEEE/RoHS-compliant, free of whiskers according to IEC 60068-2-82/ JEDEC JESD 201
Contact material	Cu alloy
Surface characteristics	Selective coating
Metal surface terminal point (top layer)	Tin (4 - 8 µm Sn)

Printed-circuit board connector - PC 16/ 4-STF-10,16 - 1967472

Technical data

Material data - contact

Metal surface terminal point (middle layer)	Nickel flash (Ni flash)
Metal surface contact area (top layer)	Silver (2 - 4 µm Ag)
Metal surface contact area (middle layer)	Nickel flash (Ni flash),

Material data - housing

Housing color	green (6021)
Insulating material	PA
Insulating material group	I
CTI according to IEC 60112	600
Flammability rating according to UL 94	V0
Glow wire flammability index GWFI according to EN 60695-2-12	850
Glow wire ignition temperature GWIT according to EN 60695-2-13	775
Temperature for the ball pressure test according to EN 60695-10-2	125 °C

Dimensions for the product

Caption	The figure shows the 3-pos. version
Length [l]	41.5 mm
Width [w]	58.4 mm
Height [h]	27.8 mm
Pitch	10.16 mm
Height (without solder pin)	27.8 mm

Packaging information

Type of packaging	packed in cardboard
Pieces per package	25
Denomination packing units	Pcs.

Ambient conditions

Ambient temperature (storage/transport)	-40 °C ... 70 °C
Ambient temperature (assembly)	-5 °C ... 100 °C
Ambient temperature (operation)	-40 °C ... 100 °C (dependent on the derating curve)

Termination and connection method

Mechanical tests according to standard

Test specification	IEC 61984
--------------------	-----------

Air clearances and creepage distances

Clearances and creepage distances	IEC 60664-1:2007-04
Specification	IEC 60664-1:2007-04
Minimum clearance - inhomogeneous field (III/3)	8 mm
Minimum clearance - inhomogeneous field (III/2)	8 mm
Minimum clearance - inhomogeneous field (II/2)	5.5 mm
Minimum creepage distance value (III/3)	12.5 mm
Minimum creepage distance value (III/2)	8 mm

Printed-circuit board connector - PC 16/ 4-STF-10,16 - 1967472

Technical data

Air clearances and creepage distances

Minimum creepage distance value (II/2)	5.5 mm
--	--------

Current carrying capacity / derating curves

Specification	IEC 61984:2008-10
Reduction factor	0.8
Note	Representation based on IEC 60512-5-2:2002-02
	For number of positions, see diagram

Mechanical tests (A)

Test specification	IEC 61984
--------------------	-----------

Thermal tests (C)

Specification	IEC 60512-5-1:2002-02
Number of positions	9
Conductor cross section	16 mm ²
Test current	76 A DC
Upper limiting temperature requirements <100 °C	Test passed

Environmental Product Compliance

REACH SVHC	Lead 7439-92-1
China RoHS	Environmentally Friendly Use Period = 50 years
	For details about hazardous substances go to tab "Downloads", Category "Manufacturer's declaration"

Drawings

Printed-circuit board connector - PC 16/ 4-STF-10,16 - 1967472

Diagram

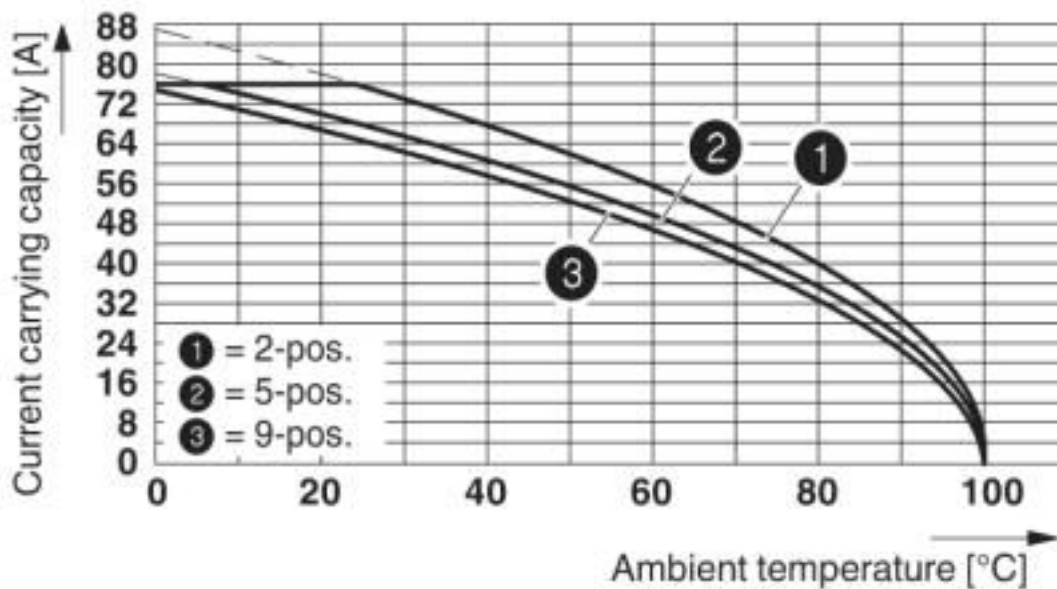

Derating curve for: PC 16/...-ST-10,16 with DFK-PC 6-16/...-G-10,16

Diagram

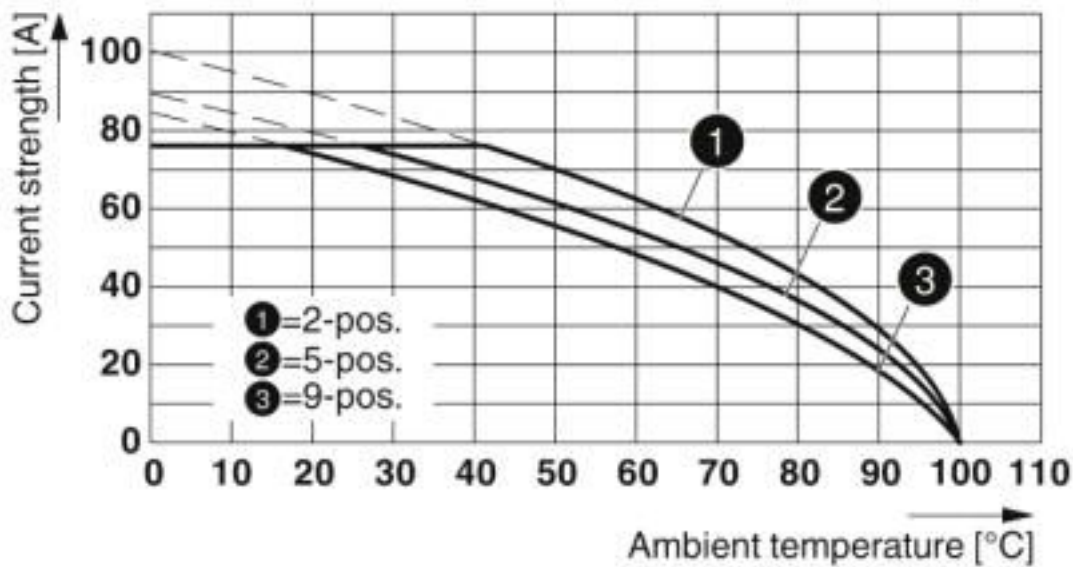

Type: PC 16/...-STF-10,16 with IPC 16/...-STGF-10,16

Printed-circuit board connector - PC 16/ 4-STF-10,16 - 1967472

Dimensional drawing

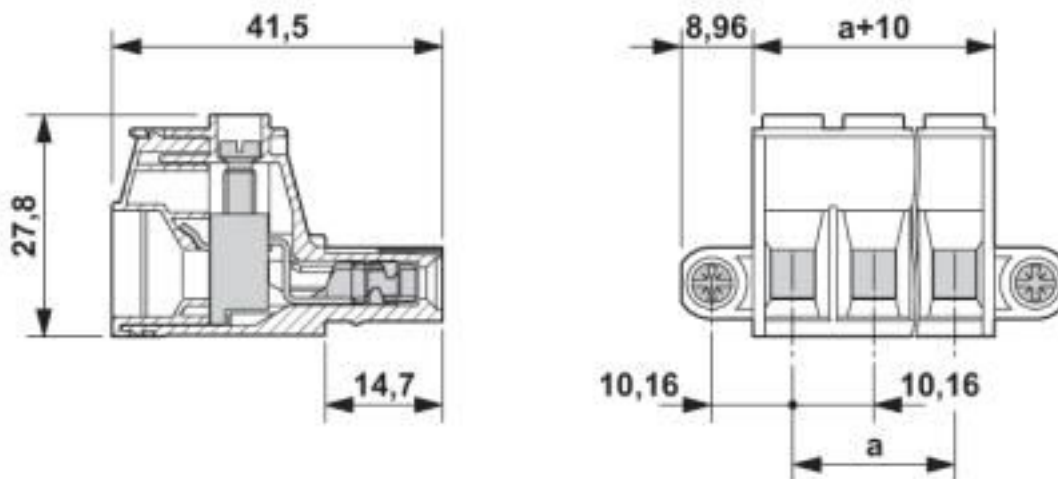

The figure shows the 3-pos. version

Classifications

eCl@ss

eCl@ss 10.0.1	27440309
eCl@ss 4.0	27260700
eCl@ss 4.1	27260700
eCl@ss 5.0	27260700
eCl@ss 5.1	27260700
eCl@ss 6.0	27260700
eCl@ss 7.0	27440309
eCl@ss 8.0	27440309
eCl@ss 9.0	27440309

ETIM

ETIM 3.0	EC001121
ETIM 4.0	EC002638
ETIM 5.0	EC002638
ETIM 6.0	EC002638
ETIM 7.0	EC002638

UNSPSC

UNSPSC 6.01	30211810
UNSPSC 7.0901	39121409
UNSPSC 11	39121409
UNSPSC 12.01	39121409
UNSPSC 13.2	39121409
UNSPSC 18.0	39121409

Printed-circuit board connector - PC 16/ 4-STF-10,16 - 1967472

Classifications

UNSPSC

UNSPSC 19.0	39121409
UNSPSC 20.0	39121409
UNSPSC 21.0	39121409

Approvals

Approvals

Approvals

SEV / EAC / cULus Recognized / IECCEB Scheme

Ex Approvals

Approval details

SEV		https://www.eurofins.ch/de/	IK-4468-M1
Nominal voltage UN		1000 V	
Nominal current IN		76 A	
mm ² /AWG/kcmil		16	

EAC		B.01687
-----	---	---------

cULus Recognized		http://database.ul.com/cgi-bin/XYV/template/LISEXT/1FRAME/index.htm	E60425-20040202
	B	C	
Nominal voltage UN	600 V	600 V	
Nominal current IN	55 A	55 A	
mm ² /AWG/kcmil	20-6	20-6	

IECCEB Scheme		http://www.iecee.org/	CH-10653-M1
Nominal voltage UN		1000 V	

Printed-circuit board connector - PC 16/ 4-STF-10,16 - 1967472

Approvals

Nominal current IN	76 A
mm ² /AWG/kcmil	16

Accessories

Accessories

Coding element

Coding profile - CP-PC RD - 1701967

Coding profile, for plugging into the coding ribs of the plug at a later date, insulating material, color: Red



Crimping tool

Crimping pliers - CRIMPFOX 6 - 1212034



Crimping pliers, for ferrules without insulating collar according to DIN 46228 Part 1 and ferrules with insulating collar according to DIN 46228 Part 4, 0.25 mm² ... 6.0 mm², lateral entry, trapezoidal crimp

Crimping pliers - CRIMPFOX 16 S - 1207983



Crimping pliers for ferrules up to 16 mm²

Screwdriver tools

Screwdriver - SZS 1,0X4,0 VDE - 1205066



Screwdriver, slot-headed, VDE insulated, size: 1.0 x 4.0 x 100 mm, 2-component grip, with non-slip grip

Terminal marking

Printed-circuit board connector - PC 16/ 4-STF-10,16 - 1967472

Accessories

Marker strip - SK 5,0 WH:REEL - 0805221



Marker strip, Roll, white, unlabeled, can be labeled with: THERMOMARK ROLL 2.0, THERMOMARK ROLL, THERMOMARK ROLL X1, THERMOMARK ROLLMASTER 300/600, THERMOMARK X1.2, mounting type: adhesive, for terminal block width: 5 mm, lettering field size: continuous x 5#mm, Number of individual labels: 90000

Additional products

Feed-through header - PCV 6-16/ 4-G1F-10,16 - 1998881



PCB headers, nominal current: 76 A, rated voltage (III/2): 1000 V, nominal cross section: 16 mm², number of positions: 4, pitch: 10.16 mm, color: green, contact surface: Silver, mounting: Wave soldering, pin layout: Linear pinning, solder pin [P]: 4 mm

Feed-through header - PC 6-16/ 4-G1F-10,16 - 1999026



PCB headers, nominal current: 76 A, rated voltage (III/2): 1000 V, nominal cross section: 16 mm², number of positions: 4, pitch: 10.16 mm, color: green, contact surface: Silver, mounting: Wave soldering, pin layout: Linear pinning, solder pin [P]: 4 mm

Feed-through header - PC 6-16/ 4-G1FU-10,16 - 1996333



PCB headers, nominal current: 76 A, rated voltage (III/2): 1000 V, nominal cross section: 16 mm², number of positions: 4, pitch: 10.16 mm, color: green, contact surface: Silver, mounting: Wave soldering, pin layout: Linear pinning, solder pin [P]: 4 mm

Printed-circuit board connector - IPC 16/ 4-STGF-10,16 - 1975833



PCB connector, nominal current: 76 A, rated voltage (III/2): 1000 V, nominal cross section: 16 mm², number of positions: 4, pitch: 10.16 mm, connection method: Screw connection with tension sleeve, color: green, contact surface: Silver

Printed-circuit board connector - PC 16/ 4-STF-10,16 - 1967472

Accessories

Printed-circuit board connector - ISPC 16/ 4-STGF-10,16 - 1748723



PCB connector, nominal current: 76 A, rated voltage (III/2): 1000 V, nominal cross section: 16 mm², number of positions: 4, pitch: 10.16 mm, connection method: Push-in spring connection, color: green, contact surface: Silver

Feed-through plug - DFK-PC 16/ 4-STF-10,16 - 1703470



Feed-through connector, nominal current: 76 A, rated voltage (III/2): 1000 V, nominal cross section: 16 mm², number of positions: 4, pitch: 10.16 mm, connection method: Screw connection with tension sleeve, color: green, contact surface: Silver

Feed-through plug - DFK-PC 16/ 4-STF-SH-10,16 - 1703632



Feed-through connector, nominal current: 76 A, rated voltage (III/2): 1000 V, nominal cross section: 16 mm², number of positions: 4, pitch: 10.16 mm, connection method: Screw connection with tension sleeve, color: green, contact surface: Silver, solder pin [P]: 4.1 mm

Feed-through header - DFK-PC 6-16/ 4-GF-10,16 - 1701553



Feed-through header, nominal current: 76 A, rated voltage (III/2): 1000 V, nominal cross section: 16 mm², number of positions: 4, pitch: 10.16 mm, color: green, contact surface: Silver, mounting: Wave soldering, pin layout: Linear pinning, solder pin [P]: 4.1 mm

Feed-through header - DFK-PC 6-16/ 4-GFU-10,16 - 1701715



Feed-through header, nominal current: 76 A, rated voltage (III/2): 1000 V, nominal cross section: 16 mm², number of positions: 4, pitch: 10.16 mm, color: green, contact surface: Silver, mounting: Wave soldering, pin layout: Linear pinning, solder pin [P]: 4.1 mm

Printed-circuit board connector - PC 16/ 4-STF-10,16 - 1967472

Accessories

Feed-through header - DFK-PCV 6-16/ 4-GF-10,16 - 1702277



Feed-through header, nominal current: 76 A, rated voltage (III/2): 1000 V, nominal cross section: 16 mm², number of positions: 4, pitch: 10.16 mm, color: green, contact surface: Silver, mounting: Wave soldering, pin layout: Linear pinning

Feed-through header - DFK-PC 6-16/ 4-GF-SH-10,16 - 1701951



Feed-through header, nominal current: 76 A, rated voltage (III/2): 1000 V, nominal cross section: 16 mm², number of positions: 4, pitch: 10.16 mm, color: green, contact surface: Silver, mounting: Wave soldering, pin layout: Linear pinning, solder pin [P]: 4.1 mm

Feed-through header - DFK-PC 6-16/ 4-GFU-SH-10,16 - 1702031



Feed-through header, nominal current: 76 A, rated voltage (III/2): 1000 V, nominal cross section: 16 mm², number of positions: 4, pitch: 10.16 mm, color: green, contact surface: Silver, mounting: Wave soldering, pin layout: Linear pinning, solder pin [P]: 4.1 mm

Phoenix Contact 2020 © - all rights reserved
<http://www.phoenixcontact.com>

PHOENIX CONTACT GmbH & Co. KG
Flachsmarktstr. 8
32825 Blomberg
Germany
Tel. +49 5235 300
Fax +49 5235 3 41200
<http://www.phoenixcontact.com>

X-ON Electronics

Largest Supplier of Electrical and Electronic Components

Click to view similar products for [Pluggable Terminal Blocks](#) category:

Click to view products by [Phoenix Contact](#) manufacturer:

Other Similar products are found below :

[57.510.0053](#) [MC 1.5/ 6-ST-3.5 GY AU](#) [734-104](#) [734-302](#) [8-141-P](#) [8426620000](#) [860505](#) [860810](#) [GBPACX-12](#) [93.731.4953.0](#) [PV05-5,08-K](#)
[PVP02-5,00](#) [PVP03-3,50](#) [PVP04-3,50](#) [PVS02-5,00](#) [1-1986160-3](#) [1377680000](#) [1531000000](#) [1546228-5](#) [ELFH16150](#) [ELFP03110](#)
[ELFP10210](#) [ELFT06250](#) [ELVP03100](#) [1700101](#) [1700410](#) [1700425](#) [1702246](#) [1705229](#) [1710175](#) [1714537](#) [1717806](#) [1719600](#) [1728941](#)
[1734692](#) [1734795](#) [1736036](#) [1740194](#) [1740291](#) [1740628](#) [1740990](#) [1746952](#) [1750207](#) [1752441](#) [1752865](#) [1754115](#) [1754144](#) [1756913](#)
[1760051](#) [1760336](#)