

# Printed-circuit board connector - IPC 16/ 9-STF-10,16 - 1969522

Please be informed that the data shown in this PDF Document is generated from our Online Catalog. Please find the complete data in the user's documentation. Our General Terms of Use for Downloads are valid (<http://phoenixcontact.com/download>)

PCB connector, nominal current: 76 A, rated voltage (III/2): 1000 V, nominal cross section: 16 mm<sup>2</sup>, number of positions: 9, pitch: 10.16 mm, connection method: Screw connection with tension sleeve, color: green, contact surface: Silver



The figure shows a 5-pos. version of the product

## Your advantages

- Well-known connection principle allows worldwide use
- Low temperature rise, thanks to maximum contact force
- Allows connection of two conductors
- Inverted connector with pin contacts for touch-proof device outputs or free-hanging cable/cable connections
- Screwable flange for superior mechanical stability

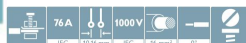

## Key Commercial Data

Packing unit	25 pc
GTIN	 4 017918 943769
GTIN	4017918943769

## Technical data

### Item properties

Brief article description	Printed-circuit board connector
Plug-in system	POWER COMBICON 16
Type of contact	Male connector
Range of articles	IPC 16/...STF
Pitch	10.16 mm
Number of positions	9
Connection method	Screw connection with tension sleeve
Drive form screw head	Slotted (L)
Screw thread	M4
Locking	Screw flange

# Printed-circuit board connector - IPC 16/ 9-STF-10,16 - 1969522

## Technical data

### Item properties

Number of levels	1
Number of connections	9
Number of potentials	9

### Electrical parameters

Nominal current	76 A
Nom. voltage	1000 V
Rated voltage	1000 V
Rated voltage (III/2)	1000 V
Rated voltage (II/2)	1000 V
Rated surge voltage (III/3)	8 kV
Rated surge voltage (III/2)	8 kV
Rated surge voltage (II/2)	6 kV

### Connection capacity

Connection method	Screw connection with tension sleeve
pluggable	Yes
Conductor cross section solid	0.75 mm <sup>2</sup> ... 16 mm <sup>2</sup>
Conductor cross section flexible	0.75 mm <sup>2</sup> ... 16 mm <sup>2</sup>
Conductor cross section AWG / kcmil	18 ... 6
Conductor cross section flexible, with ferrule without plastic sleeve	0.5 mm <sup>2</sup> ... 16 mm <sup>2</sup>
Conductor cross section, flexible, with ferrule, with plastic sleeve	0.5 mm <sup>2</sup> ... 10 mm <sup>2</sup>
2 conductors with same cross section, solid	0.75 mm <sup>2</sup> ... 6 mm <sup>2</sup>
2 conductors with same cross section, flexible	0.75 mm <sup>2</sup> ... 6 mm <sup>2</sup>
2 conductors with same cross section, flexible, with ferrule without plastic sleeve	0.5 mm <sup>2</sup> ... 4 mm <sup>2</sup>
2 conductors with the same cross section, flexible, with TWIN ferrule with plastic sleeve	0.5 mm <sup>2</sup> ... 6 mm <sup>2</sup>
Stripping length	12 mm
Torque	1.7 Nm ... 1.8 Nm

### Flange specifications

Type of locking	Screw locking
Mounting flange	Screw flange
Torque	0.3 Nm ... 0.7 Nm

### Material data - contact

Note	WEEE/RoHS-compliant, free of whiskers according to IEC 60068-2-82/ JEDEC JESD 201
Contact material	Cu alloy
Metal surface terminal point (top layer)	Silver (4 - 8 µm Ag)
Metal surface contact area (top layer)	Silver (4 - 8 µm Ag)

### Material data - housing

# Printed-circuit board connector - IPC 16/ 9-STF-10,16 - 1969522

## Technical data

### Material data - housing

Housing color	green (6021)
Insulating material	PA
Insulating material group	I
CTI according to IEC 60112	600
Flammability rating according to UL 94	V0
Glow wire flammability index GWFI according to EN 60695-2-12	850
Glow wire ignition temperature GWIT according to EN 60695-2-13	775
Temperature for the ball pressure test according to EN 60695-10-2	125 °C

### Dimensions for the product

Caption	The figure shows the 3-pos. version
Length [ l ]	44.1 mm
Width [ w ]	109.2 mm
Height [ h ]	27.8 mm
Pitch	10.16 mm
Height (without solder pin)	27.8 mm

### Packaging information

Type of packaging	packed in cardboard
Pieces per package	25
Denomination packing units	Pcs.

### Ambient conditions

Ambient temperature (storage/transport)	-40 °C ... 70 °C
Ambient temperature (assembly)	-5 °C ... 100 °C
Ambient temperature (operation)	-40 °C ... 100 °C (dependent on the derating curve)

### Air clearances and creepage distances

Clearances and creepage distances	IEC 60664-1:2007-04
Specification	IEC 60664-1:2007-04
Minimum clearance - inhomogeneous field (III/3)	8 mm
Minimum clearance - inhomogeneous field (III/2)	8 mm
Minimum clearance - inhomogeneous field (II/2)	5.5 mm
Minimum creepage distance value (III/3)	12.5 mm
Minimum creepage distance value (III/2)	8 mm
Minimum creepage distance value (II/2)	5.5 mm

### Environmental Product Compliance

REACH SVHC	Lead 7439-92-1
China RoHS	Environmentally Friendly Use Period = 50 years
	For details about hazardous substances go to tab "Downloads", Category "Manufacturer's declaration"

## Drawings

# Printed-circuit board connector - IPC 16/ 9-STF-10,16 - 1969522

Dimensional drawing

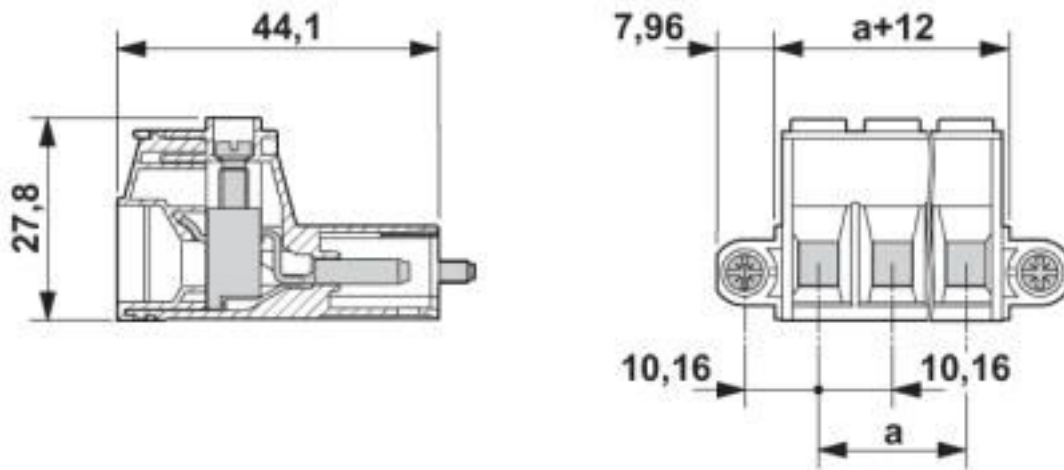

The figure shows the 3-pos. version

## Classifications

eCl@ss

eCl@ss 10.0.1	27440309
eCl@ss 4.0	27260700
eCl@ss 4.1	27260700
eCl@ss 5.0	27260700
eCl@ss 5.1	27260700
eCl@ss 6.0	27260700
eCl@ss 7.0	27440309
eCl@ss 8.0	27440309
eCl@ss 9.0	27440309

ETIM

ETIM 3.0	EC001121
ETIM 4.0	EC002638
ETIM 5.0	EC002638
ETIM 6.0	EC002638
ETIM 7.0	EC002638

UNSPSC

UNSPSC 6.01	30211810
UNSPSC 7.0901	39121409
UNSPSC 11	39121409
UNSPSC 12.01	39121409
UNSPSC 13.2	39121409
UNSPSC 18.0	39121409

# Printed-circuit board connector - IPC 16/ 9-STF-10,16 - 1969522

## Classifications

### UNSPSC

UNSPSC 19.0	39121409
UNSPSC 20.0	39121409
UNSPSC 21.0	39121409

## Approvals

### Approvals

#### Approvals

IECEE CB Scheme / SEV / EAC / cULus Recognized

#### Ex Approvals

### Approval details

IECEE CB Scheme		<a href="http://www.iecee.org/">http://www.iecee.org/</a>	CH-10653-M1
Nominal voltage UN	1000 V		
Nominal current IN	76 A		
mm <sup>2</sup> /AWG/kcmil	16		

SEV		<a href="https://www.eurofins.ch/de/">https://www.eurofins.ch/de/</a>	IK-4468-M1
Nominal voltage UN	1000 V		
Nominal current IN	76 A		
mm <sup>2</sup> /AWG/kcmil	16		

EAC		B.01687
-----	---	---------

cULus Recognized		<a href="http://database.ul.com/cgi-bin/XYV/template/LISEXT/1FRAME/index.htm">http://database.ul.com/cgi-bin/XYV/template/LISEXT/1FRAME/index.htm</a>	E60425-20040202
Nominal voltage UN	B 600 V	C 600 V	

# Printed-circuit board connector - IPC 16/ 9-STF-10,16 - 1969522

## Approvals

	B	C
Nominal current IN	55 A	55 A
mm <sup>2</sup> /AWG/kcmil	20-6	20-6

## Accessories

### Accessories

#### Coding element

Coding profile - CP-PC RD - 1701967

Coding profile, for plugging into the coding ribs of the plug at a later date, insulating material, color: Red



---

## Crimping tool

Crimping pliers - CRIMPFOX 6 - 1212034



Crimping pliers, for ferrules without insulating collar according to DIN 46228 Part 1 and ferrules with insulating collar according to DIN 46228 Part 4, 0.25 mm<sup>2</sup> ... 6.0 mm<sup>2</sup>, lateral entry, trapezoidal crimp

---

Crimping pliers - CRIMPFOX 16 S - 1207983



Crimping pliers for ferrules up to 16 mm<sup>2</sup>

---

## Screwdriver tools

Screwdriver - SZS 1,0X4,0 VDE - 1205066



Screwdriver, slot-headed, VDE insulated, size: 1.0 x 4.0 x 100 mm, 2-component grip, with non-slip grip

---

## Terminal marking

## Printed-circuit board connector - IPC 16/ 9-STF-10,16 - 1969522

### Accessories

Marker strip - SK 5,0 WH:REEL - 0805221



Marker strip, Roll, white, unlabeled, can be labeled with: THERMOMARK ROLL 2.0, THERMOMARK ROLL, THERMOMARK ROLL X1, THERMOMARK ROLLMASTER 300/600, THERMOMARK X1.2, mounting type: adhesive, for terminal block width: 5 mm, lettering field size: continuous x 5#mm, Number of individual labels: 90000

---

### Additional products

Feed-through header - IPC 16/ 9-GF-10,16 - 1969687



PCB headers, nominal current: 76 A, rated voltage (III/2): 1000 V, nominal cross section: 16 mm<sup>2</sup>, number of positions: 9, pitch: 10.16 mm, color: green, contact surface: Silver, mounting: Wave soldering, pin layout: Linear three-way pinning, solder pin [P]: 4 mm

Feed-through header - IPC 16/ 9-GFU-10,16 - 1970003



PCB headers, nominal current: 76 A, rated voltage (III/2): 1000 V, nominal cross section: 16 mm<sup>2</sup>, number of positions: 9, pitch: 10.16 mm, color: green, contact surface: Silver, mounting: Wave soldering, pin layout: Linear pinning, solder pin [P]: 4 mm, Plug direction parallel to the PCB: connector part rotated by 180° with respect to the plug axis.

Feed-through header - IPCV 16/ 9-GF-10,16 - 1969849



PCB headers, nominal current: 76 A, rated voltage (III/2): 1000 V, nominal cross section: 16 mm<sup>2</sup>, number of positions: 9, pitch: 10.16 mm, color: green, contact surface: Silver, mounting: Wave soldering, pin layout: Linear pinning, solder pin [P]: 4 mm

Feed-through header - DFK-IPC 16/ 9-GF-SH-10,16 - 1703043



Feed-through header, nominal current: 76 A, rated voltage (III/2): 1000 V, nominal cross section: 16 mm<sup>2</sup>, number of positions: 9, pitch: 10.16 mm, color: green, contact surface: Silver, mounting: Wave soldering, pin layout: Linear pinning, solder pin [P]: 4.1 mm

## Printed-circuit board connector - IPC 16/ 9-STF-10,16 - 1969522

### Accessories

#### Feed-through header - DFK-IPC 16/ 9-GFU-SH-10,16 - 1702963



Feed-through header, nominal current: 76 A, rated voltage (III/2): 1000 V, nominal cross section: 16 mm<sup>2</sup>, number of positions: 9, pitch: 10.16 mm, color: green, contact surface: Silver, mounting: Wave soldering, pin layout: Linear pinning, solder pin [P]: 4.1 mm

---

#### Feed-through header - DFK-IPCV 16/ 9-GF-10,16 - 1703289



Feed-through header, nominal current: 76 A, rated voltage (III/2): 1000 V, nominal cross section: 16 mm<sup>2</sup>, number of positions: 9, pitch: 10.16 mm, color: green, contact surface: Silver, mounting: Wave soldering, pin layout: Linear pinning, solder pin [P]: 4.1 mm

---

#### Feed-through plug - DFK-IPC 16/ 9-STF-10,16 - 1703849



Feed-through connector, nominal current: 76 A, rated voltage (III/2): 1000 V, nominal cross section: 16 mm<sup>2</sup>, number of positions: 9, pitch: 10.16 mm, connection method: Screw connection with tension sleeve, color: green, contact surface: Silver

---

#### Feed-through plug - DFK-IPC 16/ 9-STF-SH-10,16 - 1704000



Feed-through connector, nominal current: 76 A, rated voltage (III/2): 1000 V, nominal cross section: 16 mm<sup>2</sup>, number of positions: 9, pitch: 10.16 mm, connection method: Screw connection with tension sleeve, color: green, contact surface: Silver



## X-ON Electronics

Largest Supplier of Electrical and Electronic Components

*Click to view similar products for [Pluggable Terminal Blocks](#) category:*

*Click to view products by [Phoenix Contact](#) manufacturer:*

Other Similar products are found below :

[57.510.0053](#) [MC 1.5/ 6-ST-3.5 GY AU](#) [734-104](#) [734-302](#) [8-141-P](#) [8426620000](#) [860505](#) [860810](#) [GBPACX-12](#) [93.731.4953.0](#) [PV05-5,08-K](#)  
[PVP02-5,00](#) [PVP03-3,50](#) [PVP04-3,50](#) [PVS02-5,00](#) [1-1986160-3](#) [1377680000](#) [1531000000](#) [1546228-5](#) [ELFH16150](#) [ELFP03110](#)  
[ELFP10210](#) [ELFT06250](#) [ELVP03100](#) [1700101](#) [1700410](#) [1700425](#) [1702246](#) [1705229](#) [1710175](#) [1714537](#) [1717806](#) [1719600](#) [1728941](#)  
[1734692](#) [1734795](#) [1736036](#) [1740194](#) [1740291](#) [1740628](#) [1740990](#) [1746952](#) [1750207](#) [1752441](#) [1752865](#) [1754115](#) [1754144](#) [1756913](#)  
[1760051](#) [1760336](#)