

Feed-through header - ST 4-PCB/10-G-6,2 - 1980679

Please be informed that the data shown in this PDF Document is generated from our Online Catalog. Please find the complete data in the user's documentation. Our General Terms of Use for Downloads are valid (<http://phoenixcontact.com/download>)



ST-COMBI receptacle, plug-in direction horizontal to the PCB, pitch: 6.2 mm, no. of positions: 10

The figure shows the 5-pos. version

Your advantages

- Universal plug-in solutions from the DIN rail through to the device can be implemented with the same plug
- The pitch width of this base strip is matched to that of the COMBI plug



Key Commercial Data

Packing unit	50 pc
GTIN	 4 017918 972349
GTIN	4017918972349

Technical data

Dimensions

Length [l]	25.1 mm
Width	64.05 mm
Pitch	6.2 mm
Width [w]	64.05 mm
Height [h]	29.45 mm
Installed height	25.95 mm
Length of the solder pin	3.5 mm
Length	25.1 mm

General

Range of articles	ST 4-PCB/..-G
Insulating material group	I
Maximum load current	32 A (with 6 mm ² conductor cross section)
Insulating material	PA

Feed-through header - ST 4-PCB/10-G-6,2 - 1980679

Technical data

General

Flammability rating according to UL 94	V0
Color	gray
Internal cylindrical gage	A4
Number of positions	10

Standards and Regulations

Connection in acc. with standard	CUL
Flammability rating according to UL 94	V0

Environmental Product Compliance

China RoHS	Environmentally friendly use period: unlimited = EFUP-e
	No hazardous substances above threshold values

Drawings

Dimensional drawing

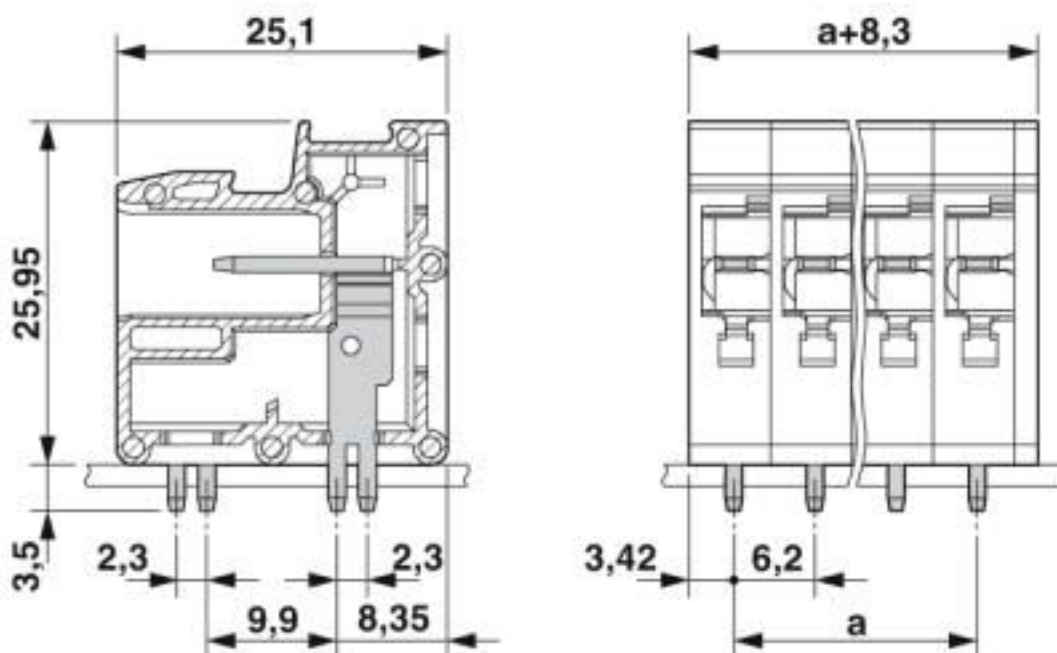

Classifications

eCl@ss

eCl@ss 10.0.1	27440402
eCl@ss 4.0	27260700
eCl@ss 4.1	27260700
eCl@ss 5.0	27260700
eCl@ss 5.1	27260700

Feed-through header - ST 4-PCB/10-G-6,2 - 1980679

Classifications

eCl@ss

eCl@ss 6.0	27260700
eCl@ss 7.0	27440402
eCl@ss 8.0	27440402
eCl@ss 9.0	27440402

ETIM

ETIM 3.0	EC001121
ETIM 4.0	EC002637
ETIM 5.0	EC002637
ETIM 6.0	EC002637
ETIM 7.0	EC002637

UNSPSC

UNSPSC 6.01	30211810
UNSPSC 7.0901	39121409
UNSPSC 11	39121409
UNSPSC 12.01	39121409
UNSPSC 13.2	39121409
UNSPSC 18.0	39121409
UNSPSC 19.0	39121409
UNSPSC 20.0	39121409
UNSPSC 21.0	39121409

Approvals

Approvals

Approvals

EAC / cULus Recognized / EAC

Ex Approvals

Approval details

EAC		RU C- DE.A*30.B.01742
-----	---	--------------------------

Feed-through header - ST 4-PCB/10-G-6,2 - 1980679

Approvals

cULus Recognized		http://database.ul.com/cgi-bin/XYV/template/LISEXT/1FRAME/index.htm	E60425-19941110
	B	C	
Nominal voltage UN	600 V	600 V	
Nominal current IN	20 A	20 A	

EAC		B.01687
-----	---	---------

Phoenix Contact 2020 © - all rights reserved
<http://www.phoenixcontact.com>

PHOENIX CONTACT GmbH & Co. KG
Flachsmarktstr. 8
32825 Blomberg
Germany
Tel. +49 5235 300
Fax +49 5235 3 41200
<http://www.phoenixcontact.com>

X-ON Electronics

Largest Supplier of Electrical and Electronic Components

Click to view similar products for [Pluggable Terminal Blocks](#) category:

Click to view products by [Phoenix Contact](#) manufacturer:

Other Similar products are found below :

[57.510.0053](#) [MC 1.5/ 6-ST-3.5 GY AU](#) [734-104](#) [734-302](#) [8-141-P](#) [8426620000](#) [860505](#) [860810](#) [GBPACX-12](#) [93.731.4953.0](#) [PV05-5,08-K](#)
[PVP02-5,00](#) [PVP03-3,50](#) [PVP04-3,50](#) [PVS02-5,00](#) [1-1986160-3](#) [1377680000](#) [1531000000](#) [1546228-5](#) [ELFH16150](#) [ELFP03110](#)
[ELFP10210](#) [ELFT06250](#) [ELVP03100](#) [1700101](#) [1700410](#) [1700425](#) [1702246](#) [1705229](#) [1710175](#) [1714537](#) [1717806](#) [1719600](#) [1728941](#)
[1734692](#) [1734795](#) [1736036](#) [1740194](#) [1740291](#) [1740628](#) [1740990](#) [1746952](#) [1750207](#) [1752441](#) [1752865](#) [1754115](#) [1754144](#) [1756913](#)
[1760051](#) [1760336](#)