

PCB terminal block - PTSA 0,5/20-2,5-F - 1989926

Please be informed that the data shown in this PDF Document is generated from our Online Catalog. Please find the complete data in the user's documentation. Our General Terms of Use for Downloads are valid (<http://phoenixcontact.com/download>)



PCB terminal block, nominal current: 2 A, rated voltage (III/2): 250 V, nominal cross section: 0.5 mm², pitch: 2.5 mm, number of positions: 20, connection method: Push-in spring connection, mounting: Wave soldering, conductor/PCB connection direction: 45 °, color: green, Pin layout: Linear pinning, Solder pin [P]: 3.6 mm. Soldering legs in front area, one-rowed

The figure shows a 10-position version of the product

Your advantages

- Time saving push-in connection, tools not required
- Defined contact force ensures that contact remains stable over the long term
- Angled connection enables multi-row arrangement on the PCB



Key Commercial Data

Packing unit	50 pc
GTIN	 4 017918 973520
GTIN	4017918973520

Technical data

Item properties

Brief article description	PCB terminal block
Range of articles	PTSA 0,5
Pitch	2.5 mm
Number of positions	20
Connection method	Push-in spring connection
Mounting type	Wave soldering
Pin layout	Linear pinning
Number of levels	1
Number of connections	20
Number of potentials	20

Electrical parameters

PCB terminal block - PTSA 0,5/20-2,5-F - 1989926

Technical data

Electrical parameters

Nominal current	2 A
Nom. voltage	250 V
Rated voltage	63 V
Rated voltage (III/2)	250 V
Rated voltage (II/2)	320 V
Rated surge voltage (III/3)	2.5 kV
Rated surge voltage (III/2)	2.5 kV
Rated surge voltage (II/2)	2.5 kV

Connection capacity

Connection method	Push-in spring connection
pluggable	no
Conductor cross section solid	0.14 mm ² ... 0.5 mm ²
Conductor cross section flexible	0.2 mm ² ... 0.5 mm ²
Conductor cross section AWG / kcmil	24 ... 20
Stripping length	9 mm

Material data - contact

Note	WEEE/RoHS-compliant, free of whiskers according to IEC 60068-2-82/ JEDEC JESD 201
Contact material	Cu alloy
Surface characteristics	hot-dip tin-plated
Metal surface terminal point (top layer)	Tin (4 - 8 µm Sn)
Metal surface soldering area (top layer)	Tin (4 - 8 µm Sn)

Material data - housing

Housing color	green (6021)
Insulating material	PA
Insulating material group	I
CTI according to IEC 60112	600
Flammability rating according to UL 94	V0
Glow wire flammability index GWFI according to EN 60695-2-12	850
Glow wire ignition temperature GWIT according to EN 60695-2-13	775
Temperature for the ball pressure test according to EN 60695-10-2	125 °C

Dimensions for the product

Caption	The figure shows the 5-pos. version
Length [l]	12 mm
Width [w]	51.5 mm
Height [h]	16.7 mm
Pitch	2.5 mm
Height (without solder pin)	13.1 mm
Solder pin [P]	3.6 mm

PCB terminal block - PTSA 0,5/20-2,5-F - 1989926

Technical data

Dimensions for the product

Pin spacing	2.5 mm
Pin dimensions	0.4 x 0.75 mm

Dimensions for PCB design

Hole diameter	1 mm
Pin spacing	2.5 mm

Packaging information

Type of packaging	packed in cardboard
Pieces per package	50
Denomination packing units	Pcs.

Ambient conditions

Ambient temperature (storage/transport)	-40 °C ... 70 °C
Ambient temperature (assembly)	-5 °C ... 55 °C
Ambient temperature (operation)	-40 °C ... 85 °C

Termination and connection method

Connection test	IEC 60998-2-2:1991-10
Test result	Test passed
Test for conductor damage and slackening	IEC 60998-2-2:1991-10
	Test passed

Pull-out test

Pull-out test	IEC 60998-2-2:1991-10
	Test passed
Conductor cross section / conductor type / tensile force	0.14 mm ² / solid / > 7 N
	0.2 mm ² / flexible / > 10 N
	0.5 mm ² / solid / > 30 N
	0.5 mm ² / flexible / > 30 N

Mechanical tests according to standard

Test specification	IEC 60998-2-2 (in parts)
--------------------	--------------------------

Electrical tests

Rated current	2 A
Conductor cross section	0.5 mm ²
Rated voltage (III/2)	250 V
Rated surge voltage (III/2)	2.5 kV

Air clearances and creepage distances

Clearances and creepage distances	IEC 60947-1:2007-06 + A1:2010-12 + A2:2014-09
Specification	IEC 60947-1:2007-06 + A1:2010-12 + A2:2014-09
Minimum clearance - inhomogeneous field (III/3)	1.5 mm
Minimum clearance - inhomogeneous field (III/2)	1.5 mm

PCB terminal block - PTSA 0,5/20-2,5-F - 1989926

Technical data

Air clearances and creepage distances

Minimum clearance - inhomogeneous field (II/2)	1.5 mm
Minimum creepage distance value (III/3)	1.6 mm
Minimum creepage distance value (III/2)	1.5 mm
Minimum creepage distance value (II/2)	1.6 mm

Temperature-rise test

Specification	IEC 60998-2-1:1990-04
Result	Test passed
Requirement temperature-rise test	Increase in temperature ≤ 45 K

Current carrying capacity / derating curves

Caption	Derating diagram for 5 pins;reduction factor=1
Specification	Following IEC 60512-5-2:2002-02
Number of positions	5
Reduction factor	1

Vibration test

Specification	IEC 60068-2-6:1995-03
Result	Test passed
Frequency	10 - 150 - 10 Hz
Sweep speed	1 octave/min
Amplitude	0.35 mm (10 - 60.1 Hz)
Acceleration	5 g (60.1 - 150 Hz)
Test duration per axis	2.5 h

Resistance to ageing, humidity and penetration of solids

Dry heat	168 h/100°C
Humid heat	48 h/30 °C/92 %

Insulation resistance

Specification	IEC 60998-2-2:1991-10
Result	Test passed
Insulation resistance, neighboring positions	$10^9 \Omega$

Glow-wire test

Specification	IEC 60998-2-2:1991-10
Result	Test passed
Temperature	850 °C
Time of exposure	5 s

Mechanical strength/tumbling barrel test

Specification	IEC 60998-1:1990-04
Height of fall	50 cm
Number of drop cycles	50

PCB terminal block - PTSA 0,5/20-2,5-F - 1989926

Technical data

Standards and Regulations

Connection in acc. with standard	EN-VDE
	CUL

Environmental Product Compliance

China RoHS	Environmentally friendly use period: unlimited = EFUP-e
	No hazardous substances above threshold values

Drawings

Drilling diagram

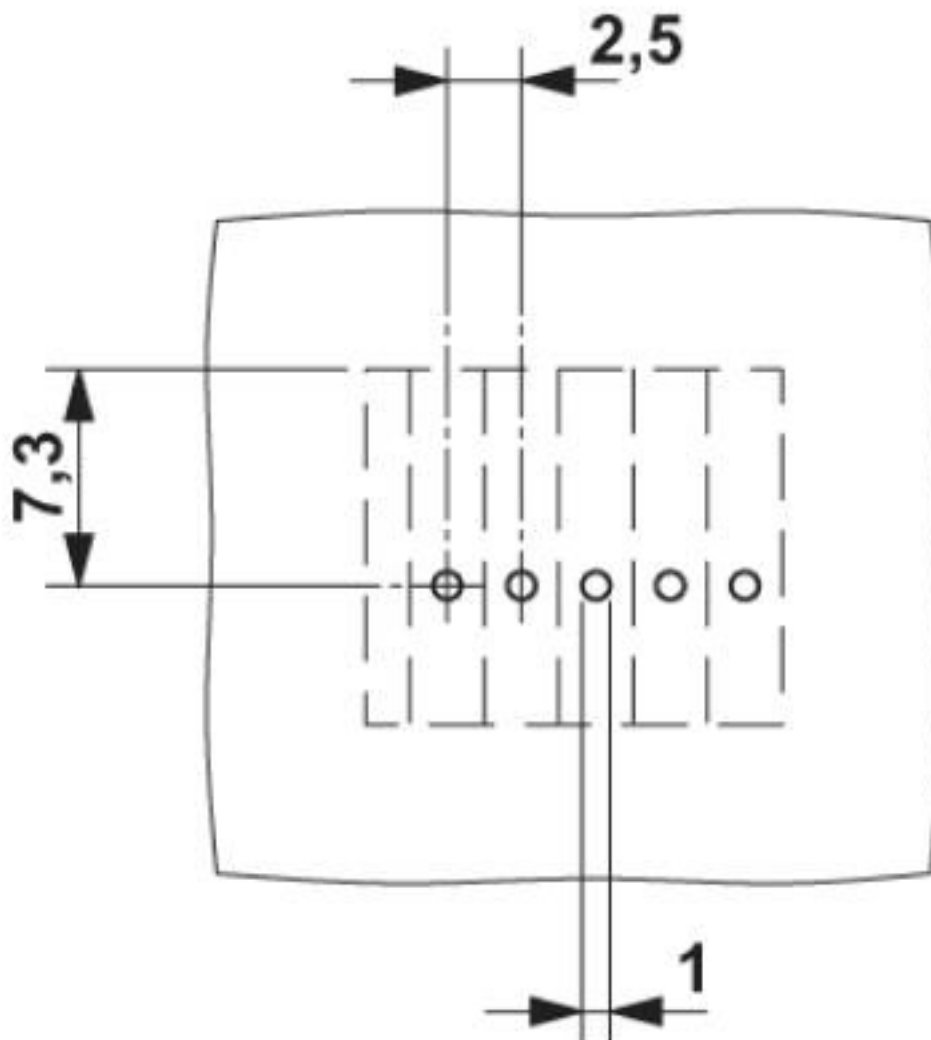

The figure shows the 5-pos. version

PCB terminal block - PTSA 0,5/20-2,5-F - 1989926

Diagram

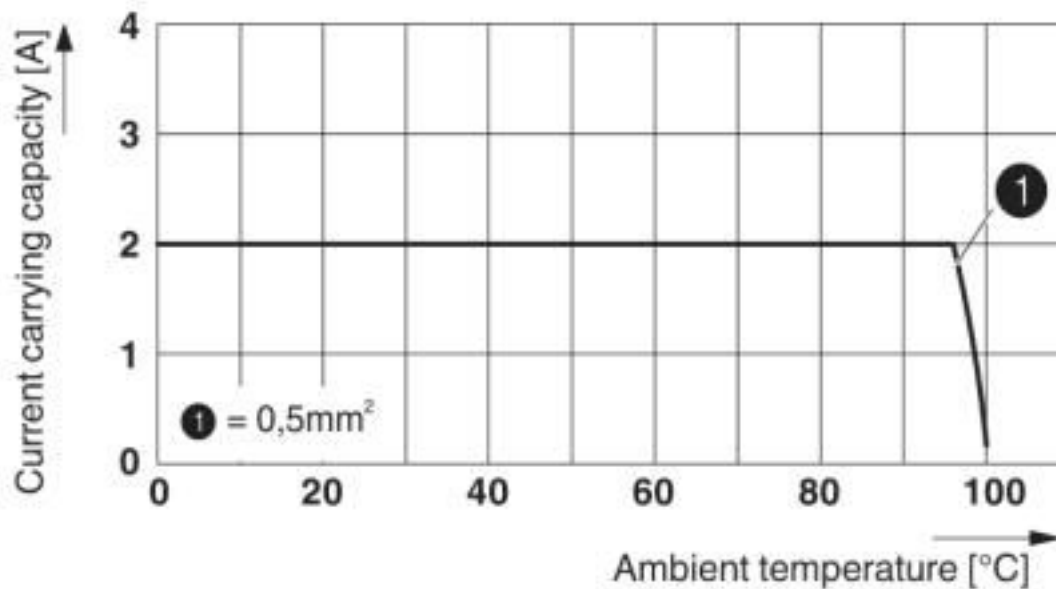

Derating diagram for 5 pins;reduction factor=1

Dimensional drawing

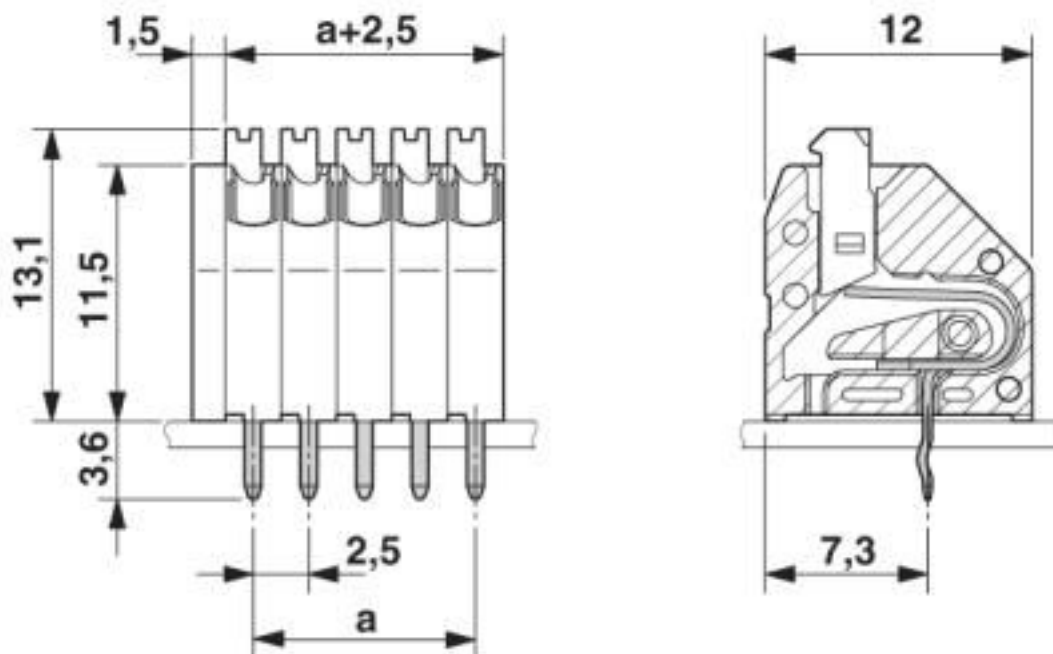

The figure shows the 5-pos. version

PCB terminal block - PTSA 0,5/20-2,5-F - 1989926

Classifications

eCl@ss

eCl@ss 10.0.1	27440401
eCl@ss 4.0	27260700
eCl@ss 4.1	27260700
eCl@ss 5.0	27141100
eCl@ss 5.1	27261100
eCl@ss 6.0	27261100
eCl@ss 7.0	27440401
eCl@ss 8.0	27440401
eCl@ss 9.0	27440401

ETIM

ETIM 3.0	EC001121
ETIM 4.0	EC002643
ETIM 5.0	EC002643
ETIM 6.0	EC002643
ETIM 7.0	EC002643

UNSPSC

UNSPSC 6.01	30211801
UNSPSC 7.0901	39121432
UNSPSC 11	34131203
UNSPSC 12.01	39121432
UNSPSC 13.2	39121432
UNSPSC 18.0	39121432
UNSPSC 19.0	39121432
UNSPSC 20.0	39121432
UNSPSC 21.0	39121432

Approvals

Approvals

Approvals

CCA / VDE Gutachten mit Fertigungsüberwachung / EAC / cULus Recognized

Ex Approvals

Approval details

PCB terminal block - PTSA 0,5/20-2,5-F - 1989926

Approvals

CCA	CCA/DE1 34204
Nominal current IN	2 A
mm ² /AWG/kcmil	0.5

VDE Gutachten mit Fertigungsüberwachung		http://www2.vde.com/de/Institut/Online-Service/VDE-gepruefteProdukte/Seiten/Online-Suche.aspx	40013932
Nominal voltage UN	130 V		
Nominal current IN	2 A		
mm ² /AWG/kcmil	0.5		

EAC		B.01687
-----	--	---------

cULus Recognized		http://database.ul.com/cgi-bin/XYV/template/LISEXT/1FRAME/index.htm	E60425-20030527
	B	D	
Nominal voltage UN	150 V	300 V	
Nominal current IN	2 A	2 A	
mm ² /AWG/kcmil	26-20	26-20	

Accessories

Accessories

Screwdriver tools

Screwdriver - SZF 0-0,4X2,5 - 1204504



Actuation tool, for ST terminal blocks, also suitable for use as a bladed screwdriver, size: 0.4 x 2.5 x 75 mm, 2-component grip, with non-slip grip

Phoenix Contact 2020 © - all rights reserved
<http://www.phoenixcontact.com>

PHOENIX CONTACT GmbH & Co. KG
Flachmarktstr. 8
32825 Blomberg
Germany
Tel. +49 5235 300
Fax +49 5235 3 41200
<http://www.phoenixcontact.com>

X-ON Electronics

Largest Supplier of Electrical and Electronic Components

Click to view similar products for [Fixed Terminal Blocks](#) category:

Click to view products by [Phoenix Contact](#) manufacturer:

Other Similar products are found below :

[MBE-1512](#) [MBE-154](#) [MBE-156](#) [MBES-153](#) [MBES-156](#) [MH-2512](#) [MHE-132](#) [MHE-163](#) [MI-254 \(35\)](#) [MI-272](#) [880507](#) [MPT-275](#)
[15602-04-08-21](#) [BA311TU](#) [BA411SU](#) [MV-152](#) [MV-252-D](#) [MV-253/NCNOC](#) [MV-254-D](#) [MV-255](#) [MV-462](#) [MV-493](#) [MVE-252](#) [MVE-253](#)
[MVE-273](#) [MVEB-153](#) [1700096](#) [1705142](#) [1712417](#) [1713020](#) [1713088](#) [1745195](#) [1760594](#) [1776118-2](#) [1790852](#) [1-796689-8](#) [1-796692-6](#)
[1800001](#) [1800114](#) [1995279](#) [20020314-C121B01LF](#) [CB2-12](#) [KP03215000J0G](#) [KP04215000J0G](#) [S451](#) [282802-2](#) [29.007](#) [29.116](#) [30.103](#)
[30.106](#)