

Feed-through header - MSTBO 2,5/ 2-G1R THRR32 BK - 2200252

Please be informed that the data shown in this PDF Document is generated from our Online Catalog. Please find the complete data in the user's documentation. Our General Terms of Use for Downloads are valid (<http://phoenixcontact.com/download>)



PCB headers, number of positions: 2, pitch: 5 mm, color: black, contact surface: Tin, pin layout: Linear pinning, solder pin [P]: 3.5 mm, Article with lateral pin exit

Your advantages

- For ME/ME MAX electronics housing
- 2, 3, and 4-pos.
- Plug-in direction orthogonal to the PCB
- 5 mm pitch
- Orthogonal headers for through hole reflow process
- Made from high-temperature-resistant polyamide for use in lead-free soldering processes.
- Supplied taped as standard, in bulk as an option
- Integrated suction surface



Key Commercial Data

Packing unit	230 pc
Minimum order quantity	230 pc
GTIN	 4 046356 546188
GTIN	4046356546188

Technical data

Dimensions

Pitch	5 mm
Dimension a	5 mm
Length of the solder pin	3.5 mm
Pin spacing	5.00 mm

General

Range of articles	MSTBO 2,5/..-G1R-THR
Insulating material group	I

Feed-through header - MSTBO 2,5/ 2-G1R THRR32 BK - 2200252

Technical data

General

Rated surge voltage (III/3)	4 kV
Rated surge voltage (III/2)	4 kV
Rated surge voltage (II/2)	4 kV
Rated voltage (III/3)	250 V
Rated voltage (III/2)	320 V
Rated voltage (II/2)	400 V
Connection in acc. with standard	EN-VDE
Nominal current I_N	16 A
Maximum load current	12 A
Insulating material	PA
Flammability rating according to UL 94	V0
Color	black
Number of positions	2

Standards and Regulations

Connection in acc. with standard	EN-VDE
	CUL
Flammability rating according to UL 94	V0

Environmental Product Compliance

China RoHS	Environmentally friendly use period: unlimited = EFUP-e
	No hazardous substances above threshold values

Drawings

Feed-through header - MSTBO 2,5/ 2-G1R THRR32 BK - 2200252

Drilling diagram

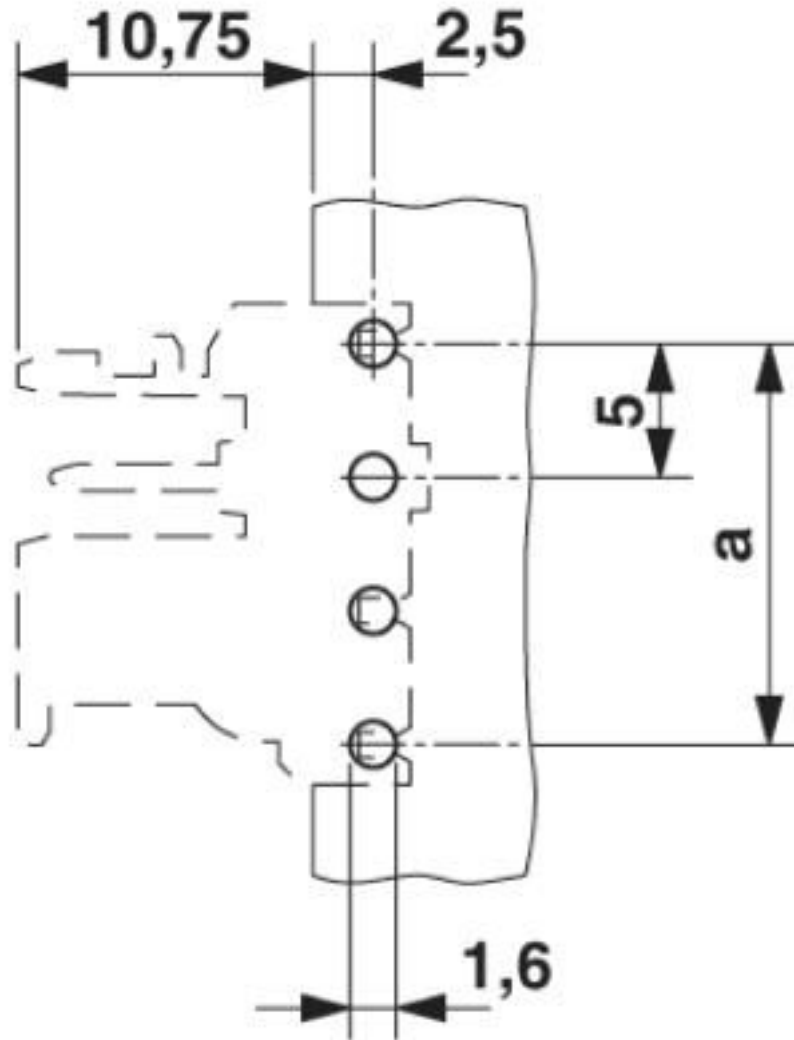

Feed-through header - MSTBO 2,5/ 2-G1R THRR32 BK - 2200252

Dimensional drawing

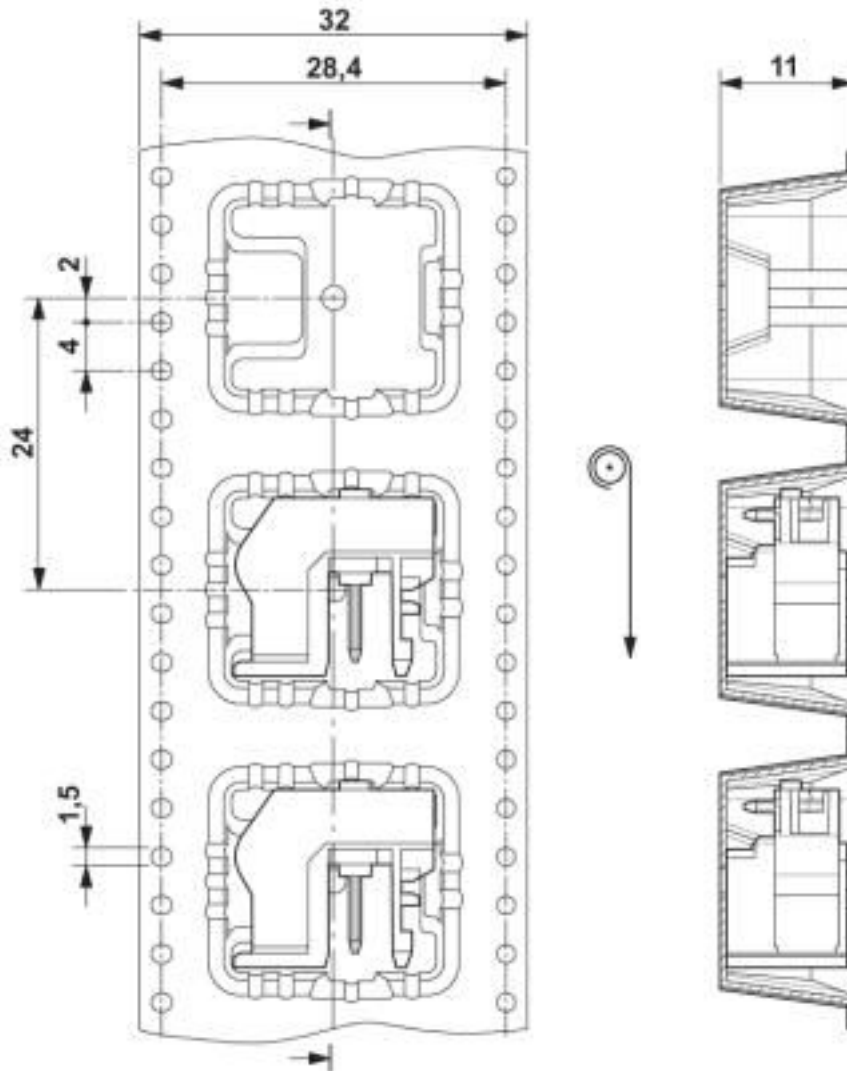

Feed-through header - MSTBO 2,5/ 2-G1R THRR32 BK - 2200252

Diagram

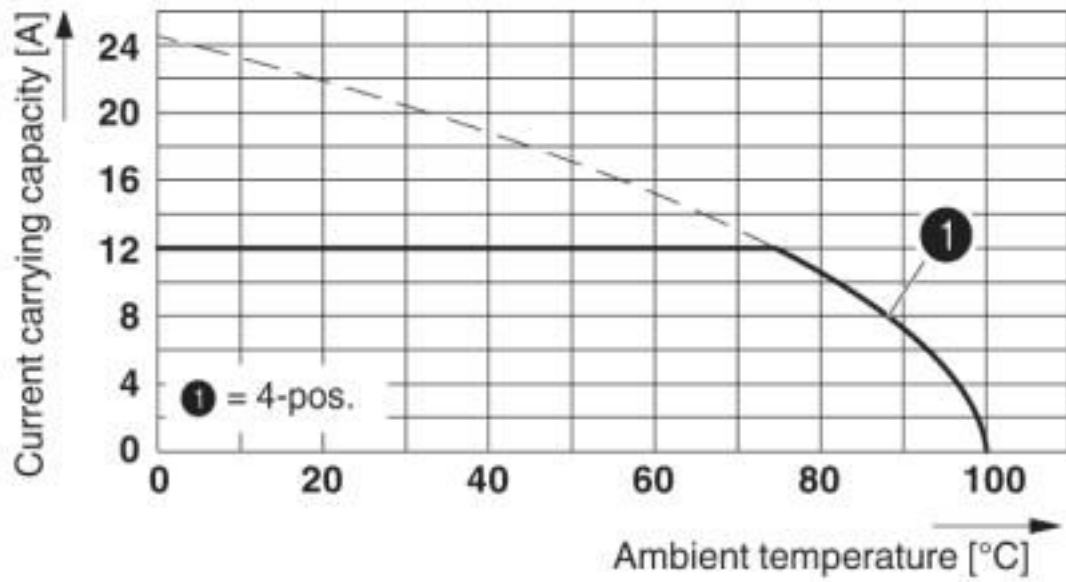

Dimensional drawing

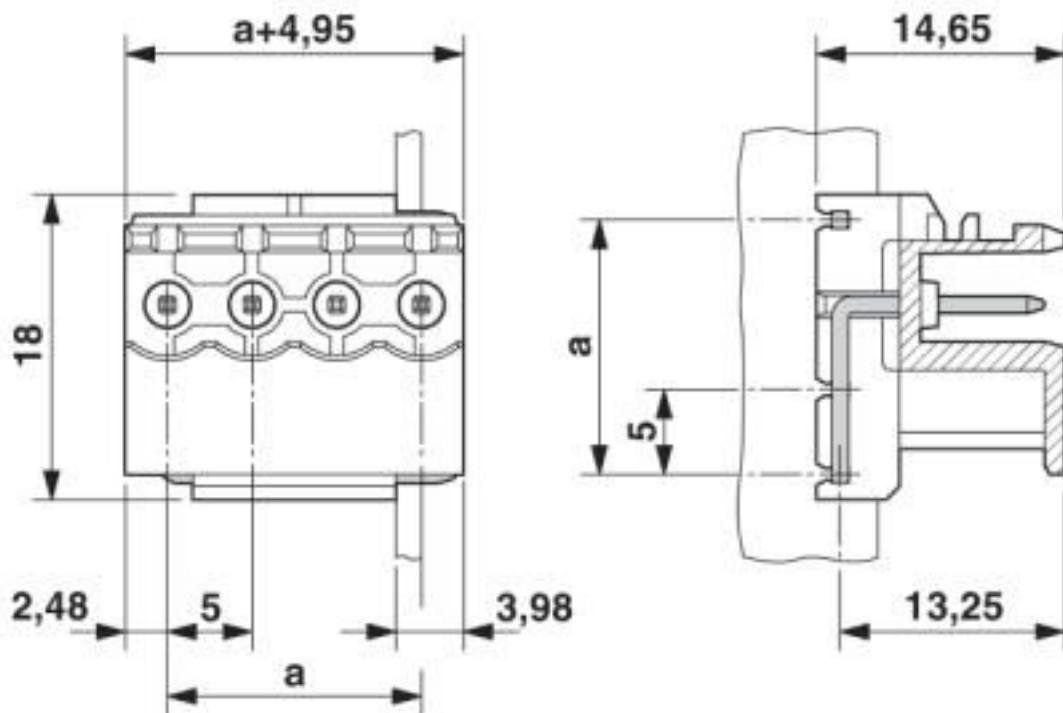

Feed-through header - MSTBO 2,5/ 2-G1R THRR32 BK - 2200252

Schematic diagram

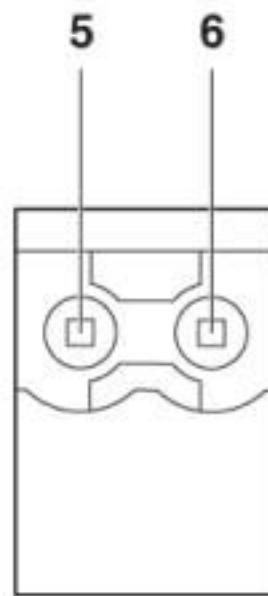
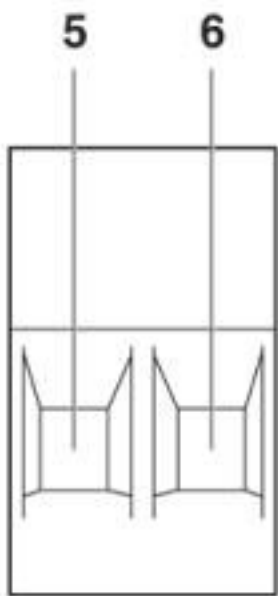

Pin assignment right

Classifications

eCl@ss

eCl@ss 10.0.1	27440402
eCl@ss 4.0	27260700
eCl@ss 4.1	27260700
eCl@ss 5.0	27260700
eCl@ss 5.1	27260700
eCl@ss 6.0	27260700
eCl@ss 7.0	27440402
eCl@ss 8.0	27440402
eCl@ss 9.0	27440402

ETIM

ETIM 3.0	EC001121
ETIM 4.0	EC002637
ETIM 5.0	EC002637
ETIM 6.0	EC002637
ETIM 7.0	EC002637

UNSPSC

UNSPSC 6.01	30211801
UNSPSC 7.0901	39121432
UNSPSC 11	34131203

Feed-through header - MSTBO 2,5/ 2-G1R THRR32 BK - 2200252

Classifications

UNSPSC

UNSPSC 12.01	39121432
UNSPSC 13.2	39121409
UNSPSC 18.0	39121409
UNSPSC 19.0	39121409
UNSPSC 20.0	39121409
UNSPSC 21.0	39121409

Approvals

Approvals

Approvals

EAC / cULus Recognized

Ex Approvals

Approval details

EAC		B.01687
-----	--	---------

cULus Recognized		http://database.ul.com/cgi-bin/XYV/template/LISEXT/1FRAME/index.htm	E60425-20050718
	B	D	
Nominal voltage UN	300 V	300 V	
Nominal current IN	16 A	10 A	

Accessories

Accessories

Coding element

Coding section - CR MSTBO-G1 - 2199618

Coding section, inserted into the recess in the header or the inverted plug, red insulating material



Feed-through header - MSTBO 2,5/ 2-G1R THRR32 BK - 2200252

Accessories

Filler plug

Accessories - MSTB-BL - 1755477



Keying cap, for forming sections, plugs onto header pin, green insulating material

Flange

Accessories - MSTB-BF - 1759981



Mounting flange, for fixing both ends of the header onto the PCB, green insulating material, with M 2 x 14 screws and nuts.

Necessary add-on products

Printed-circuit board connector - MSTBT 2,5/ 2-ST KMGY - 1920545



PCB connector, nominal current: 12 A, rated voltage (III/2): 320 V, nominal cross section: 2.5 mm², number of positions: 2, pitch: 5 mm, connection method: Screw connection with tension sleeve, color: light gray, contact surface: Tin, pin layout: Linear pinning

Printed-circuit board connector - MSTBT 2,5/ 2-ST - 1779835



PCB connector, nominal current: 12 A, rated voltage (III/2): 320 V, nominal cross section: 2.5 mm², number of positions: 2, pitch: 5 mm, connection method: Screw connection with tension sleeve, color: green, contact surface: Tin

Printed-circuit board connector - MSTBT 2,5 HC/ 2-ST - 1926358



PCB connector, nominal current: 16 A, rated voltage (III/2): 320 V, nominal cross section: 2.5 mm², number of positions: 2, pitch: 5 mm, connection method: Screw connection with tension sleeve, color: green, contact surface: Tin, The T-shape of the MSTBT plug distributes the height uniformly over the upper and lower sides of the printed circuit board

Additional products

Feed-through header - MSTBO 2,5/ 2-G1R THRR32 BK - 2200252

Accessories

Printed-circuit board connector - TVFKC 1,5/ 2-ST - 1713839



PCB connector, nominal current: 10 A, rated voltage (III/2): 320 V, nominal cross section: 1.5 mm², number of positions: 2, pitch: 5 mm, connection method: Push-in spring connection, color: green, contact surface: Tin, pin layout: Linear pinning

Printed-circuit board connector - TVFKCL 1,5/ 2-ST - 1715921



PCB connector, nominal current: 10 A, rated voltage (III/2): 320 V, nominal cross section: 1.5 mm², number of positions: 2, pitch: 5 mm, connection method: Push-in spring connection, color: green, contact surface: Tin

Plug - QC 1,5/ 2-ST - 1717961

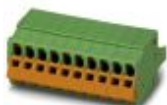

PCB connector, nominal current: 12 A, rated voltage (III/2): 630 V, nominal cross section: 1.5 mm², number of positions: 2, pitch: 5 mm, connection method: Displacement connection, color: green, contact surface: Tin

Printed-circuit board connector - FKCN 2,5/ 2-ST - 1732742



PCB connector, nominal current: 12 A, rated voltage (III/2): 320 V, nominal cross section: 2.5 mm², number of positions: 2, pitch: 5 mm, connection method: Push-in spring connection, color: green, contact surface: Tin

Printed-circuit board connector - MSTB 2,5/ 2-ST - 1754449



PCB connector, nominal current: 12 A, rated voltage (III/2): 320 V, nominal cross section: 2.5 mm², number of positions: 2, pitch: 5 mm, connection method: Screw connection with tension sleeve, color: green, contact surface: Tin

Feed-through header - MSTBO 2,5/ 2-G1R THRR32 BK - 2200252

Accessories

Printed-circuit board connector - MSTBP 2,5/ 2-ST - 1765771



PCB connector, nominal current: 12 A, rated voltage (III/2): 320 V, nominal cross section: 2.5 mm², number of positions: 2, pitch: 5 mm, connection method: Screw connection with tension sleeve, color: green, contact surface: Tin

Printed-circuit board connector - SMSTB 2,5/ 2-ST - 1768765



PCB connector, nominal current: 12 A, rated voltage (III/2): 320 V, nominal cross section: 2.5 mm², number of positions: 2, pitch: 5 mm, connection method: Screw connection with tension sleeve, color: green, contact surface: Tin

Printed-circuit board connector - FRONT-MSTB 2,5/ 2-ST - 1779411



PCB connector, nominal current: 12 A, rated voltage (III/2): 320 V, nominal cross section: 2.5 mm², number of positions: 2, pitch: 5 mm, connection method: Front screw connection, color: green, contact surface: Tin

Printed-circuit board connector - MSTBT 2,5/ 2-ST - 1779835



PCB connector, nominal current: 12 A, rated voltage (III/2): 320 V, nominal cross section: 2.5 mm², number of positions: 2, pitch: 5 mm, connection method: Screw connection with tension sleeve, color: green, contact surface: Tin

Printed-circuit board connector - MVSTBR 2,5/ 2-ST - 1792016



PCB connector, nominal current: 12 A, rated voltage (III/2): 320 V, nominal cross section: 2.5 mm², number of positions: 2, pitch: 5 mm, connection method: Screw connection with tension sleeve, color: green, contact surface: Tin

Feed-through header - MSTBO 2,5/ 2-G1R THRR32 BK - 2200252

Accessories

Printed-circuit board connector - MVSTBW 2,5/ 2-ST - 1792524



PCB connector, nominal current: 12 A, rated voltage (III/2): 320 V, nominal cross section: 2.5 mm², number of positions: 2, pitch: 5 mm, connection method: Screw connection with tension sleeve, color: green, contact surface: Tin

Printed-circuit board connector - FKCT 2,5/ 2-ST - 1909210



PCB connector, nominal current: 12 A, rated voltage (III/2): 320 V, nominal cross section: 2.5 mm², number of positions: 2, pitch: 5 mm, connection method: Push-in spring connection, color: green, contact surface: Tin

Printed-circuit board connector - FKCVR 2,5/ 2-ST - 1909715



PCB connector, nominal current: 12 A, rated voltage (III/2): 320 V, nominal cross section: 2.5 mm², number of positions: 2, pitch: 5 mm, connection method: Push-in spring connection, color: green, contact surface: Tin

Printed-circuit board connector - FKCVW 2,5/ 2-ST - 1910034



PCB connector, nominal current: 12 A, rated voltage (III/2): 320 V, nominal cross section: 2.5 mm², number of positions: 2, pitch: 5 mm, connection method: Push-in spring connection, color: green, contact surface: Tin

Printed-circuit board connector - FKC 2,5/ 2-ST - 1910351



PCB connector, nominal current: 12 A, rated voltage (III/2): 320 V, nominal cross section: 2.5 mm², number of positions: 2, pitch: 5 mm, connection method: Push-in spring connection, color: green, contact surface: Tin

Feed-through header - MSTBO 2,5/ 2-G1R THRR32 BK - 2200252

Accessories

Printed-circuit board connector - QC 1/ 2-ST-BUS - 1921670



PCB connector, nominal current: 10 A, rated voltage (III/2): 630 V, nominal cross section: 1 mm², number of positions: 2, pitch: 5 mm, connection method: Displacement connection, color: green, contact surface: Tin, The plug allows conductors to be looped through from module to module, without interruption

Printed-circuit board connector - FKCS 2,5/ 2-ST - 1974737



PCB connector, nominal current: 12 A, rated voltage (III/2): 320 V, nominal cross section: 2.5 mm², number of positions: 2, pitch: 5 mm, connection method: Push-in spring connection, color: green, contact surface: Tin

Phoenix Contact 2020 © - all rights reserved
<http://www.phoenixcontact.com>

PHOENIX CONTACT GmbH & Co. KG
Flachsmarktstr. 8
32825 Blomberg
Germany
Tel. +49 5235 300
Fax +49 5235 3 41200
<http://www.phoenixcontact.com>

X-ON Electronics

Largest Supplier of Electrical and Electronic Components

Click to view similar products for [Pluggable Terminal Blocks](#) category:

Click to view products by [Phoenix Contact](#) manufacturer:

Other Similar products are found below :

[57.510.0053](#) [MC 1.5/ 6-ST-3.5 GY AU](#) [734-104](#) [734-302](#) [8-141-P](#) [8426620000](#) [860505](#) [860810](#) [GBPACX-12](#) [93.731.4953.0](#) [PV05-5,08-K](#)
[PVP02-5,00](#) [PVP03-3,50](#) [PVP04-3,50](#) [PVS02-5,00](#) [1-1986160-3](#) [1377680000](#) [1531000000](#) [1546228-5](#) [ELFH16150](#) [ELFP03110](#)
[ELFP10210](#) [ELFT06250](#) [ELVP03100](#) [1700101](#) [1700410](#) [1700425](#) [1702246](#) [1705229](#) [1710175](#) [1714537](#) [1717806](#) [1719600](#) [1728941](#)
[1734692](#) [1734795](#) [1736036](#) [1740194](#) [1740291](#) [1740628](#) [1740990](#) [1746952](#) [1750207](#) [1752441](#) [1752865](#) [1754115](#) [1754144](#) [1756913](#)
[1760051](#) [1760336](#)