

Current transformer - PACT MCR-V1-21-44-400-5A-1 - 2277051

Please be informed that the data shown in this PDF Document is generated from our Online Catalog. Please find the complete data in the user's documentation. Our General Terms of Use for Downloads are valid (<http://phoenixcontact.com/download>)



Bus-bar current transformer, 400 A AC primary current; 5 A AC secondary current; accuracy class 1; 5 VA rated power



Key Commercial Data

Packing unit	1 pc
GTIN	 4 046356 305167
GTIN	4046356305167

Technical data

Dimensions

Width	30 mm
Width with alternative assembly	44 mm
Height	66 mm
Height with alternative assembly	66 mm
Depth	44 mm
Depth with alternative assembly	30 mm
Primary round conductor (diameter)	21 mm

Ambient conditions

Ambient temperature (operation)	-25 °C ... 40 °C
Ambient temperature (storage/transport)	-25 °C ... 40 °C
Maximum altitude	≤ 1000 m
Permissible humidity (operation)	Use only indoors, non-condensing

General

Converter type	Tube rod converter
Accuracy class	1
Can be calibrated	no
Color	black

Current transformer - PACT MCR-V1-21-44-400-5A-1 - 2277051

Technical data

General

Housing material	PA 6.6
------------------	--------

Input data

Thermal rated short-time current	$I_{th} = 60 * I_n$
Thermal rated continuous current	$I_d = 1.2 * I_n$
Rated surge current	$I_{dyn} = 2.5 * I_{th}$
Rated frequency: Standard converter	50 Hz ... 60 Hz
Surge current limitation factor	FS 5
Rated power	5 VA
Primary rated current I_{pn}	0 A ... 400 A
Secondary rated current I_{sn}	5 A AC

Connection data

Connection method	Screw connection
Conductor cross section flexible	2x 2.5 mm ² ... 4 mm ² ()

Standards and Regulations

Standards/regulations	EN 50178
	EN 61869
Rated insulation voltage	1 kV (Phase/neutral conductor)
UL, USA/Canada	XODW8.E323953

Conformance/approvals

Designation	UL, USA/Canada
Identification	XODW8.E323953

Environmental Product Compliance

China RoHS	Environmentally Friendly Use Period = 50 years
	For details about hazardous substances go to tab "Downloads", Category "Manufacturer's declaration"

Drawings

Current transformer - PACT MCR-V1-21-44-400-5A-1 - 2277051

Dimensional drawing

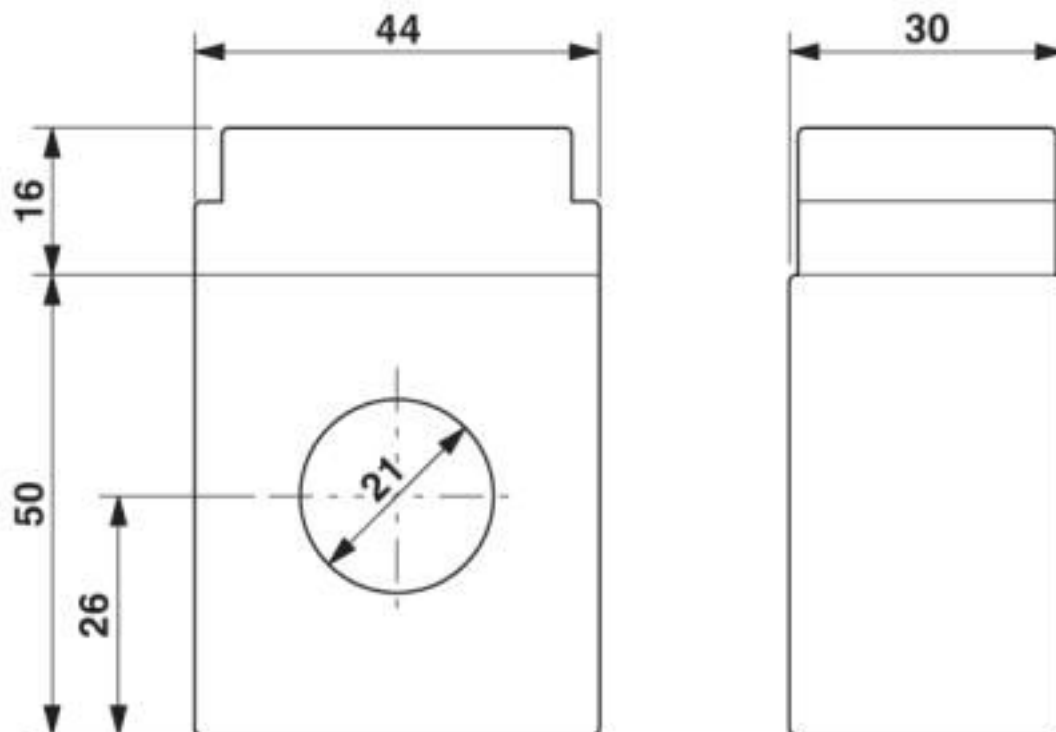

Classifications

eCl@ss

eCl@ss 10.0.1	27210902
eCl@ss 4.0	27210900
eCl@ss 4.1	27210900
eCl@ss 5.0	27210900
eCl@ss 5.1	27210900
eCl@ss 6.0	27210900
eCl@ss 7.0	27210902
eCl@ss 8.0	27210902
eCl@ss 9.0	27210902

ETIM

ETIM 3.0	EC002048
ETIM 4.0	EC002048
ETIM 5.0	EC002048
ETIM 6.0	EC002048
ETIM 7.0	EC002048

UNSPSC

UNSPSC 6.01	30211501
-------------	----------

Current transformer - PACT MCR-V1-21-44-400-5A-1 - 2277051

Classifications

UNSPSC

UNSPSC 7.0901	39121019
UNSPSC 11	39121006
UNSPSC 12.01	39121006
UNSPSC 13.2	39121032
UNSPSC 18.0	39121032
UNSPSC 19.0	39121032
UNSPSC 20.0	39121032
UNSPSC 21.0	39121032

Approvals

Approvals

Approvals

EAC

Ex Approvals

Approval details

EAC		RU*DE*08.B.01187/19
-----	---	---------------------

Phoenix Contact 2020 © - all rights reserved
<http://www.phoenixcontact.com>

PHOENIX CONTACT GmbH & Co. KG
Flachsmarktstr. 8
32825 Blomberg
Germany
Tel. +49 5235 300
Fax +49 5235 3 41200
<http://www.phoenixcontact.com>

X-ON Electronics

Largest Supplier of Electrical and Electronic Components

Click to view similar products for [Current Transformers](#) category:

Click to view products by [Phoenix Contact](#) manufacturer:

Other Similar products are found below :

[L595100](#) [ACST-260](#) [MP3500](#) [L595050](#) [BV EI 304 2089](#) [PACT RCP-4000A-UIRO-PT-D14](#) [PACT RCP-4000A-UIRO-PT-D19](#) [E54CT1L](#)
[CTD-KIT](#) [44021](#) [44104](#) [44176](#) [44248](#) [45023](#) [45041](#) [45071](#) [PA3828NL](#) [CT16-1-50A/50MA](#) [SPCT 100/60 1200/5A VA 15 CL 0.5](#) [SPCT](#)
[100/60 1000/5A VA 15 CL 0.5](#) [SPCT 100/60 600/5 A VA 7.5 CL 1](#) [SPCT 100/60 600/5 A VA 5 CL 0.5](#) [SPCT 100/60 800/5 A VA 10 CL 0.5](#)
[SPCT 140/100 1200/5A VA 15 CL 0.5](#) [SPCT 140/100 1250/5A VA 15 CL 0.5](#) [SPCT 140/100 1500/5A VA 15 CL 0.5](#) [SPCT 140/100 1600/5A](#)
[VA 15 CL 0.5](#) [SPCT 140/100 1000/5A VA 15 CL 0.5](#) [SPCT 140/100 2500/5A VA 15 CL 0.5](#) [SPCT 140/100 2000/5A VA 15 CL 0.5](#) [SPCT](#)
[140/100 3000/5A VA 15 CL 0.5](#) [SPCT 140/100 800/5A VA 15 CL 0.5](#) [SPCT 62/30 50/5A VA1 CL 3](#) [SPCT 62/30 60/5A VA1 CL 3](#) [SPCT](#)
[62/30 75/5A VA1 CL 3](#) [SPCT 62/30 75/5A VA3 CL 3](#) [SPCT 62/40 100/5 A VA 1 CL 1](#) [SPCT 62/40 125/5 A VA 1 CL 1](#) [SPCT 62/40 150/5 A](#)
[VA 3 CL 1](#) [SPCT 62/40 160/5 A VA 1.5 CL 1](#) [SPCT 62/40 200/5 A VA 2,5 CL 0,5](#) [SPCT 62/40 200/5 A VA 3 CL 1](#) [SPCT 62/40 250/5 A VA](#)
[3 CL 1](#) [SPCT 62/40 300/5 A VA 3 CL 0.5](#) [SPCT 62/40 400/5 A VA 3.75 CL 0.5](#) [2CSM029000R1211](#) [HPT205NBJ-1](#) [HCT204KFH](#) [HCT20K-](#)
[QD](#) [HPT205A/F](#)