

Interface module - DFLK-D25 SUB/B - 2280323

Please be informed that the data shown in this PDF Document is generated from our Online Catalog. Please find the complete data in the user's documentation. Our General Terms of Use for Downloads are valid (<http://phoenixcontact.com/download>)



The VARIOFACE feed-through module implements a 1:1 connection between screw connection terminal blocks and a D-SUB miniature socket strip (number of positions: 25). A separate ground tap is available.

Your advantages

- 9 to 50-pos.
- 9 to 37-pos.: separate ground tap
- 50-pos.: no ground tap
- According to IEC 60807-2
- 1:1 connection
- Screw connection
- D-SUB 4-40 UNC thread

Key Commercial Data

Packing unit	5 pc
GTIN	 4 017918 054434
GTIN	4017918054434

Technical data

Dimensions

Width	40 mm
Height	83.5 mm
Depth	33.5 mm

Ambient conditions

Ambient temperature (operation)	-20 °C ... 50 °C
Ambient temperature (storage/transport)	-20 °C ... 70 °C
Degree of protection	IP20

General

Nominal voltage U_N	25 V AC
-----------------------	---------

Interface module - DFLK-D25 SUB/B - 2280323

Technical data

General

	60 V DC
Max. perm. current (per branch)	2.5 A
Max. permissible current (all branches)	50 A
Number of positions	25
Mounting position	any
Assembly instructions	In rows with zero spacing

Connection data

Connection name	Field level
Connection in acc. with standard	IEC / EN
Connection method	Screw connection
Stripping length	8 mm
Screw thread	M3
Conductor cross section solid	0.2 mm ² ... 4 mm ²
Conductor cross section flexible	0.2 mm ² ... 2.5 mm ²
Conductor cross section AWG	24 ... 12

Connection data 2

Connection name	Controller level
Connection method	D-SUB socket strip
Number of positions	25

Standards and Regulations

Connection in acc. with standard	CUL
Standards/regulations	IEC 60664
	DIN EN 50178
Rated insulation voltage	125 V
Rated surge voltage	1.2 kV (Functional insulation)
Pollution degree	2
Overvoltage category	II

Environmental Product Compliance

REACH SVHC	Lead 7439-92-1
China RoHS	Environmentally Friendly Use Period = 50 years
	For details about hazardous substances go to tab "Downloads", Category "Manufacturer's declaration"

Drawings

Interface module - DFLK-D25 SUB/B - 2280323

Dimensional drawing

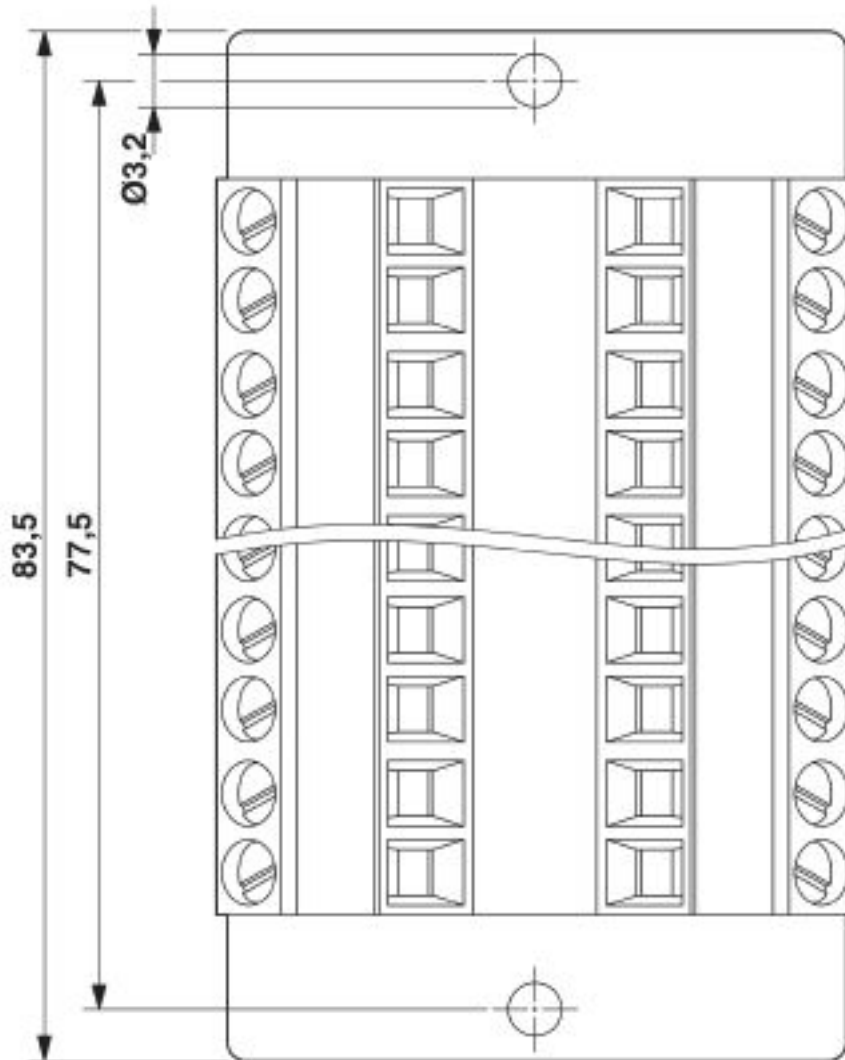

Interface module - DFLK-D25 SUB/B - 2280323

Dimensional drawing

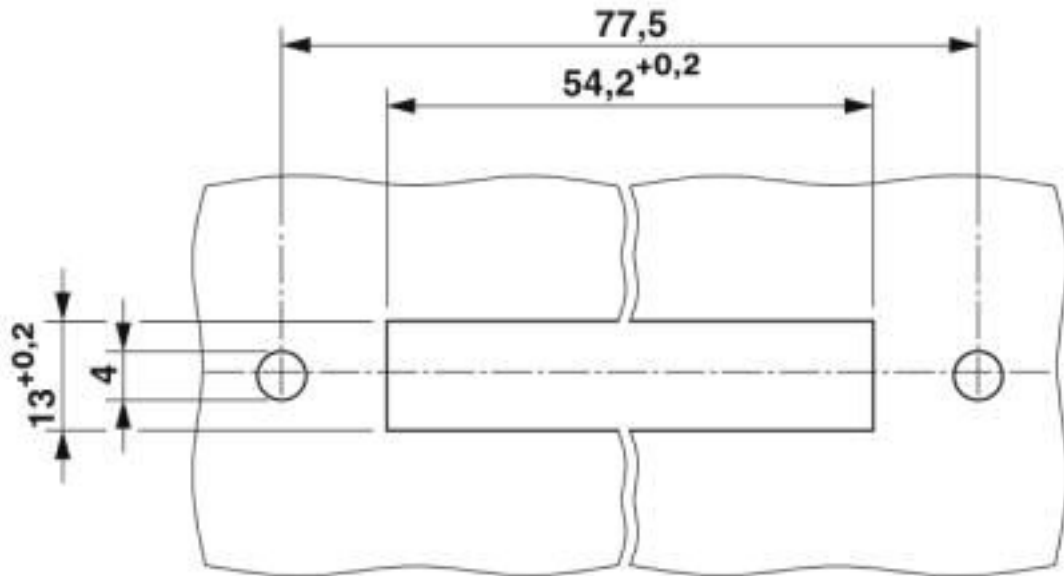

Dimensional drawing

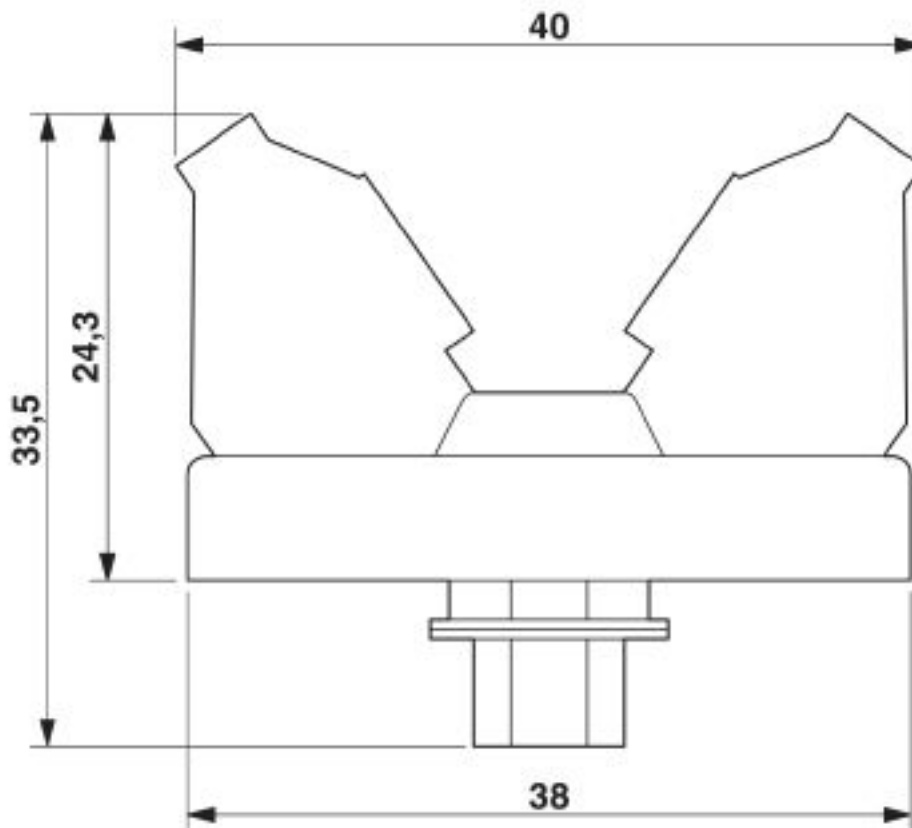

Interface module - DFLK-D25 SUB/B - 2280323

Classifications

eCl@ss

eCl@ss 10.0.1	27141152
eCl@ss 4.0	27250300
eCl@ss 4.1	27250300
eCl@ss 5.0	27250300
eCl@ss 5.1	27250300
eCl@ss 6.0	27242600
eCl@ss 7.0	27141152
eCl@ss 8.0	27141152
eCl@ss 9.0	27141152

ETIM

ETIM 4.0	EC002780
ETIM 5.0	EC002780
ETIM 6.0	EC002780
ETIM 7.0	EC002780

UNSPSC

UNSPSC 6.01	30211824
UNSPSC 7.0901	39121421
UNSPSC 11	39121421
UNSPSC 12.01	39121421
UNSPSC 13.2	39121432
UNSPSC 18.0	39121432
UNSPSC 19.0	39121432
UNSPSC 20.0	39121432
UNSPSC 21.0	39121432

Approvals

Approvals

Approvals

UL Recognized / cUL Recognized / EAC / cULus Recognized

Ex Approvals

Approval details

Interface module - DFLK-D25 SUB/B - 2280323

Approvals

UL Recognized		http://database.ul.com/cgi-bin/XYV/template/LISEXT/1FRAME/index.htm	FILE E 60425
Nominal voltage UN		125 V	
Nominal current IN		2.5 A	
mm ² /AWG/kcmil		30-12	

cUL Recognized		http://database.ul.com/cgi-bin/XYV/template/LISEXT/1FRAME/index.htm	FILE E 60425
Nominal voltage UN		125 V	
Nominal current IN		2.5 A	
mm ² /AWG/kcmil		30-12	

EAC		RU C- DE.A*30.B.01742
-----	--	--------------------------

cULus Recognized	
------------------	--

Accessories

Accessories

System cable

Cable - CABLE-D25SUB/B/S/ 50/KONFEK/S - 2302120



Assembled shielded round cable; connection 1: D-SUB socket strip (1x 25-position); connection 2: D-SUB pin strip (1x 25-position); cable length: 0.5 m

Cable - CABLE-D25SUB/B/S/100/KONFEK/S - 2302133



Assembled shielded round cable; connection 1: D-SUB socket strip (1x 25-position); connection 2: D-SUB pin strip (1x 25-position); cable length: 1 m

Interface module - DFLK-D25 SUB/B - 2280323

Accessories

Cable - CABLE-D25SUB/B/S/150/KONFEK/S - 2302146



Assembled shielded round cable; connection 1: D-SUB socket strip (1x 25-position); connection 2: D-SUB pin strip (1x 25-position); cable length: 1.5 m

Cable - CABLE-D25SUB/B/S/200/KONFEK/S - 2302159



Assembled shielded round cable; connection 1: D-SUB socket strip (1x 25-position); connection 2: D-SUB pin strip (1x 25-position); cable length: 2 m

Cable - CABLE-D25SUB/B/S/300/KONFEK/S - 2302162



Assembled shielded round cable; connection 1: D-SUB socket strip (1x 25-position); connection 2: D-SUB pin strip (1x 25-position); cable length: 3 m

Cable - CABLE-D25SUB/B/S/400/KONFEK/S - 2302175



Assembled shielded round cable; connection 1: D-SUB socket strip (1x 25-position); connection 2: D-SUB pin strip (1x 25-position); cable length: 4 m

Cable - CABLE-D25SUB/B/S/600/KONFEK/S - 2302188



Assembled shielded round cable; connection 1: D-SUB socket strip (1x 25-position); connection 2: D-SUB pin strip (1x 25-position); cable length: 6 m

Interface module - DFLK-D25 SUB/B - 2280323

Accessories

Cable - CABLE D-SUB-S/.../.../... - 2302340



Shielded round cable, assembled with one D-SUB male and one female connector, variable cable length

Cable - CABLE D-SUB-S-S-S/.../.../... - 2302434



Shielded round cable, assembled with two D-SUB male connectors, variable cable length

Cable - CABLE-D-25SUB/M/OE/0,25/S/0,5M - 2926506



Assembled shielded round cable; connection 1: Single wires (25-position) (The wires are marked and fitted with ferrules. The braided shield is routed to a separate cable end.); connection 2: D-SUB pin strip (1x 25-position); cable length: 0.5 m

Cable - CABLE-D-25SUB/M/OE/0,25/S/1,0M - 2926519



Assembled shielded round cable; connection 1: Single wires (25-position) (The wires are marked and fitted with ferrules. The braided shield is routed to a separate cable end.); connection 2: D-SUB pin strip (1x 25-position); cable length: 1 m

Cable - CABLE-D-25SUB/M/OE/0,25/S/1,5M - 2926522



Assembled shielded round cable; connection 1: Single wires (25-position) (The wires are marked and fitted with ferrules. The braided shield is routed to a separate cable end.); connection 2: D-SUB pin strip (1x 25-position); cable length: 1.5 m

Interface module - DFLK-D25 SUB/B - 2280323

Accessories

Cable - CABLE-D-25SUB/M/OE/0,25/S/2,0M - 2926535



Assembled shielded round cable; connection 1: Single wires (25-position) (The wires are marked and fitted with ferrules. The braided shield is routed to a separate cable end.); connection 2: D-SUB pin strip (1x 25-position); cable length: 2 m

Cable - CABLE-D-25SUB/M/OE/0,25/S/3,0M - 2926548



Assembled shielded round cable; connection 1: Single wires (25-position) (The wires are marked and fitted with ferrules. The braided shield is routed to a separate cable end.); connection 2: D-SUB pin strip (1x 25-position); cable length: 3 m

Cable - CABLE-D-25SUB/M/OE/0,25/S/4,0M - 2926551



Assembled shielded round cable; connection 1: Single wires (25-position) (The wires are marked and fitted with ferrules. The braided shield is routed to a separate cable end.); connection 2: D-SUB pin strip (1x 25-position); cable length: 4 m

Cable - CABLE-D-25SUB/M/OE/0,25/S/6,0M - 2926564



Assembled shielded round cable; connection 1: Single wires (25-position) (The wires are marked and fitted with ferrules. The braided shield is routed to a separate cable end.); connection 2: D-SUB pin strip (1x 25-position); cable length: 6 m

Cable - CABLE-D-25SUB-M-OE-0,25-S/... - 2900911



Assembled shielded round cable; connection 1: Single wires (25-position) (The wires are marked and fitted with ferrules. The braided shield is routed to a separate cable end.); connection 2: D-SUB pin strip (1x 25-position); cable length: variable

Phoenix Contact 2020 © - all rights reserved
<http://www.phoenixcontact.com>

PHOENIX CONTACT GmbH & Co. KG
Flachmarktstr. 8
32825 Blomberg
Germany
Tel. +49 5235 300
Fax +49 5235 3 41200
<http://www.phoenixcontact.com>

X-ON Electronics

Largest Supplier of Electrical and Electronic Components

Click to view similar products for [Terminal Block Interface Modules](#) category:

Click to view products by [Phoenix Contact](#) manufacturer:

Other Similar products are found below :

[73-551-6002I](#) [GCN1MX25B](#) [DIN-50P-01](#) [DIN-68H-01](#) [DIN-96DI-01](#) [2291901](#) [2295185](#) [2907794](#) [2M10FCL](#) [FLKM-2I/O](#) [FLKM-4I/O](#)
[2281759](#) [2906251](#) [2907808](#) [5601749](#) [5541962](#) [1776613-1](#) [GCN1-004A](#) [ADAM-3920R-AE](#) [060-6827-06](#) [2311030](#) [2287708](#) [XW2C-20G6-](#)
[IO16](#) [GCN1-T](#) [MACX](#) [MCR-VAC](#) [5775235](#) [ADAM-3956-BE](#) [XW6T-COM2.5X20YL](#) [XW6T-COM1.5X8BL](#) [XW6T-COM1.5X16BL](#)
[XW6T-COM1.5X20YL](#) [XW6T-COM1.5X16YL](#) [XW6T-COM1.5X20RD](#) [XW6T-COM1.5X20BL](#) [XW6T-COM2.5X8BL](#) [1976610000](#) [UM](#)
[45-D50SUB/B/ZFKDS](#) [5541234](#) [410-261](#) [902056](#) [2906243](#) [2906915](#) [2907706](#) [ADAM-3909-AE](#) [ADAM-3920-AE](#) [ADAM-3925-AE](#)
[ADAM-3937-BE](#) [ADAM-3950-AE](#) [ADAM-3951-BE](#) [ADAM-3968-AE](#)