

## Solid-state contactor - ELR 1-230AC/600AC-20 - 2297141

Please be informed that the data shown in this PDF Document is generated from our Online Catalog. Please find the complete data in the user's documentation. Our General Terms of Use for Downloads are valid (<http://phoenixcontact.com/download>)



Single-phase solid-state contactor, input voltage: 230 V AC, output current: 20 A, zero voltage switch

### Your advantages

- ✓ Wear and bounce-free
- ✓ High switching frequency
- ✓ 24 V DC and 230 V AC input voltage versions



### Key Commercial Data

Packing unit	1 pc
GTIN	 4 046356 132015
GTIN	4046356132015

### Technical data

#### Dimensions

Width	22.5 mm
Height	103 mm
Depth	103 mm

#### Ambient conditions

Ambient temperature (operation)	-30 °C ... 70 °C
Ambient temperature (storage/transport)	-40 °C ... 80 °C

#### Input data

Input name	Control input
Rated actuating voltage $U_c$	230 V AC
Triggering voltage range	24 V AC ... 275 V AC
Rated actuating current $I_c$	approx. 17 mA
Switching threshold	$\leq 6$ V AC ("0" signal)

# Solid-state contactor - ELR 1-230AC/600AC-20 - 2297141

## Technical data

### Input data

	≥ 22 V AC ("1" signal)
Transmission frequency	6 Hz
Operating voltage display	Green LED

### Output data load output

Output name	Load output
Operating voltage range	42 V AC ... 660 V AC
Load current range	350 mA ... 20 A (see to derating)
Rated operating current at AC-51	20 A
Rated operating current at AC-53a	5 A
Leakage current	< 3 mA (In off state)
Residual voltage	< 1.6 V
Surge current	250 A (t = 10 ms)
Type of protection	RCV circuit

### General

Test voltage input/output	4 kV <sub>rms</sub>
Mounting position	Vertical (horizontal DIN rail)
Assembly instructions	Can be aligned with ≥ 22.5 mm spacing

### Connection data

Connection name	Control circuits
Connection method	Screw connection
Stripping length	8 mm
Screw thread	M4
Conductor cross section solid	0.5 mm <sup>2</sup> ... 2.5 mm <sup>2</sup>
Conductor cross section flexible	0.5 mm <sup>2</sup> ... 2.5 mm <sup>2</sup>
Conductor cross section AWG	20 ... 14

### Connection data 2

Connection name	Load circuit
Connection method	Screw connection
Stripping length	8 mm
Screw thread	M4
Conductor cross section solid	0.5 mm <sup>2</sup> ... 4 mm <sup>2</sup>
Conductor cross section flexible	0.5 mm <sup>2</sup> ... 4 mm <sup>2</sup>
Conductor cross section AWG	20 ... 12

### Standards and Regulations

Connection in acc. with standard	CUL
Designation	Standards/regulations
Standards/regulations	EN 61000-4-2
	EN 61000-4-3

# Solid-state contactor - ELR 1-230AC/600AC-20 - 2297141

## Technical data

### Standards and Regulations

	EN 61000-4-4
	EN 61000-4-5
	EN 61000-4-6
	EN 55011

### Environmental Product Compliance

REACH SVHC	Lead 7439-92-1
China RoHS	Environmentally Friendly Use Period = 50 years
	For details about hazardous substances go to tab "Downloads", Category "Manufacturer's declaration"

## Drawings

Block diagram

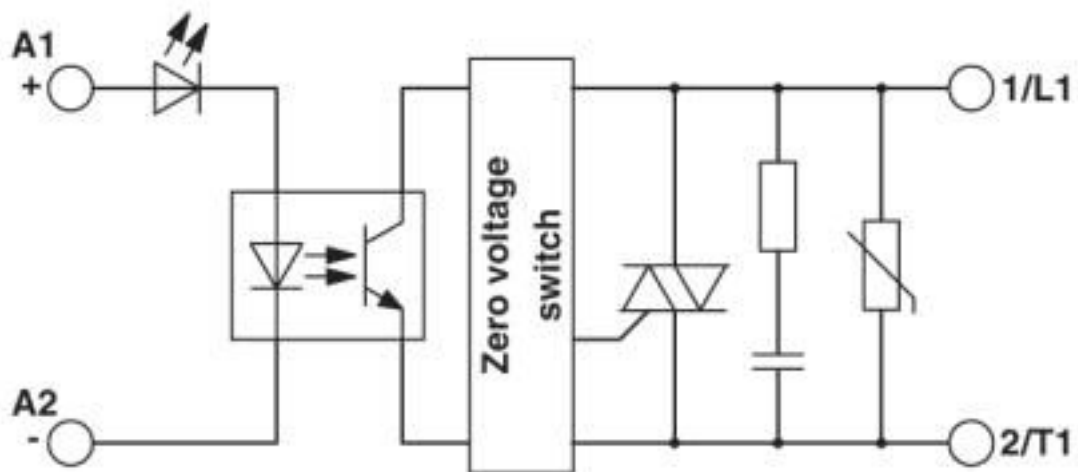

# Solid-state contactor - ELR 1-230AC/600AC-20 - 2297141

Diagram

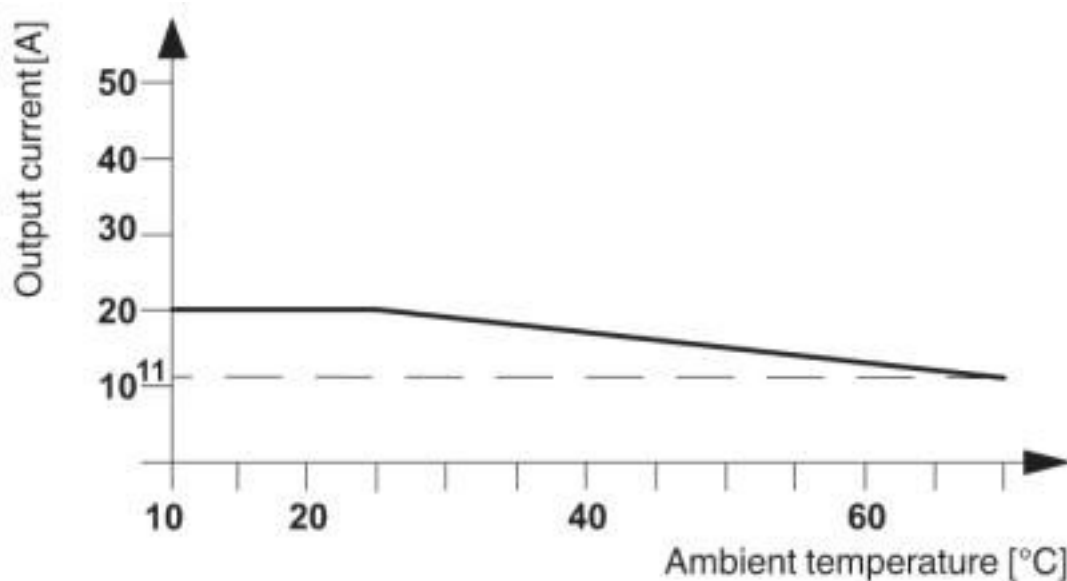

## Classifications

### eCl@ss

eCl@ss 4.0	27371100
eCl@ss 4.1	27371100
eCl@ss 5.0	27371000
eCl@ss 5.1	27371000
eCl@ss 6.0	27371000
eCl@ss 7.0	27371014
eCl@ss 8.0	27371014
eCl@ss 9.0	27371014

### ETIM

ETIM 4.0	EC002055
ETIM 5.0	EC002055
ETIM 6.0	EC002055
ETIM 7.0	EC002055

### UNSPSC

UNSPSC 6.01	30211915
UNSPSC 7.0901	39121514
UNSPSC 11	39121514
UNSPSC 12.01	39121514
UNSPSC 13.2	39121529
UNSPSC 19.0	39121529

# Solid-state contactor - ELR 1-230AC/600AC-20 - 2297141

## Approvals

### Approvals

---

#### Approvals





UL Recognized / cUL Recognized / EAC / cULus Recognized

---

#### Ex Approvals

---

### Approval details

UL Recognized		<a href="http://database.ul.com/cgi-bin/XYV/template/LISEXT/1FRAME/index.htm">http://database.ul.com/cgi-bin/XYV/template/LISEXT/1FRAME/index.htm</a>	FILE E 195083
cUL Recognized		<a href="http://database.ul.com/cgi-bin/XYV/template/LISEXT/1FRAME/index.htm">http://database.ul.com/cgi-bin/XYV/template/LISEXT/1FRAME/index.htm</a>	FILE E 195083
EAC			RU C- DE.A*30.B.01082
cULus Recognized			

---

Phoenix Contact 2020 © - all rights reserved  
<http://www.phoenixcontact.com>

PHOENIX CONTACT GmbH & Co. KG  
Flachsmarktstr. 8  
32825 Blomberg  
Germany  
Tel. +49 5235 300  
Fax +49 5235 3 41200  
<http://www.phoenixcontact.com>

## X-ON Electronics

Largest Supplier of Electrical and Electronic Components

*Click to view similar products for [Solid State Relays - Industrial Mount](#) category:*

*Click to view products by [Phoenix Contact](#) manufacturer:*

Other Similar products are found below :

[D2440-C](#) [H10CA4890](#) [D4875C](#) [1395831-1](#) [1616010-6](#) [BR312BY](#) [A-1326](#) [H10CA4850](#) [H12CA4890VL](#) [RA2410-D06](#) [RA2410HA06T](#)  
[D1202F](#) [D53TP50-10](#) [W230E-1-12](#) [W230T-3-12](#) [1-1617030-3](#) [1-1617033-7](#) [MS2-D2420](#) [MS2-D2430](#) [A-1440](#) [RJ1P60V50E](#) [HS501DR-](#)  
[D2425](#) [RN1F48I50](#) [70.362.1028.0](#) [7-1393030-8](#) [Z5.509.0828.0](#) [G3DZ-4B DC24](#) [G3DZ-F4B DC12](#) [2912138](#) [SSRDAC10](#) [SSR-10048RD1](#)  
[RV8S-L-A240-D24](#) [RV8S-L-A240-D6](#) [RV8S-S-A240-D6](#) [RV8S-S-A240Z-D24](#) [RV8S-S-D24-A240](#) [RV8S-S-D48-A120](#) [RN1F12V50](#)  
[RJ1P60I30E](#) [RJ1P60V30E](#) [SO967860](#) [SMT8628521](#) [SO869970](#) [SOD867180](#) [SAL961360](#) [SO867970](#) [SOB863860](#) [SOB867640](#) [G3PH-](#)  
[5150B DC5-24](#) [G3PH-2075B DC5-24](#)