

Solid-state contactor - ELR 1- 24DC/600AC-50 - 2297170

Please be informed that the data shown in this PDF Document is generated from our Online Catalog. Please find the complete data in the user's documentation. Our General Terms of Use for Downloads are valid (<http://phoenixcontact.com/download>)



Single-phase solid-state contactor, input voltage: 24 V DC, output current: 50 A, zero voltage switch

Your advantages

- ✓ Wear and bounce-free
- ✓ High switching frequency
- ✓ 24 V DC and 230 V AC input voltage versions

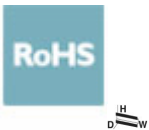

Key Commercial Data

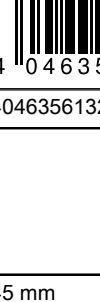
Packing unit	1 pc
GTIN	 4 046356 132046
GTIN	4046356132046

Technical data

Dimensions

Width	45 mm
Height	103 mm
Depth	103 mm

Ambient conditions

Ambient temperature (operation)	-30 °C ... 70 °C
Ambient temperature (storage/transport)	-40 °C ... 80 °C

Input data

Input name	Control input
Rated actuating voltage U_c	24 V DC
Triggering voltage range	4 V DC ... 32 V DC
Rated actuating current I_c	approx. 12 mA
Switching threshold	≤ 1 V DC ("0" signal)

Solid-state contactor - ELR 1- 24DC/600AC-50 - 2297170

Technical data

Input data

	≥ 4 V DC ("1" signal)
Transmission frequency	25 Hz
Operating voltage display	Green LED

Output data load output

Output name	Load output
Operating voltage range	42 V AC ... 660 V AC
Load current range	150 mA ... 50 A (see to derating)
Rated operating current at AC-51	50 A
Rated operating current at AC-53a	30 A
Leakage current	< 3 mA (In off state)
Residual voltage	< 1.6 V
Surge current	1900 A (t = 10 ms)
Type of protection	RCV circuit

General

Test voltage input/output	4 kV _{rms}
Mounting position	Vertical (horizontal DIN rail)
Assembly instructions	Can be aligned with ≥ 22.5 mm spacing

Connection data

Connection name	Control circuits
Connection method	Screw connection
Stripping length	8 mm
Screw thread	M3
Conductor cross section solid	0.5 mm ² ... 4 mm ²
Conductor cross section flexible	0.5 mm ² ... 4 mm ²
Conductor cross section AWG	20 ... 14

Connection data 2

Connection name	Load circuit
Connection method	Screw connection
Stripping length	8 mm
Screw thread	M5
Conductor cross section solid	4 mm ² ... 25 mm ²
Conductor cross section flexible	4 mm ² ... 25 mm ²
Conductor cross section AWG	12 ... 3

Standards and Regulations

Connection in acc. with standard	CUL
Designation	Standards/regulations
Standards/regulations	EN 61000-4-2
	EN 61000-4-3

Solid-state contactor - ELR 1- 24DC/600AC-50 - 2297170

Technical data

Standards and Regulations

	EN 61000-4-4
	EN 61000-4-5
	EN 61000-4-6
	EN 55011

Environmental Product Compliance

REACH SVHC	Lead 7439-92-1
China RoHS	Environmentally Friendly Use Period = 50 years
	For details about hazardous substances go to tab "Downloads", Category "Manufacturer's declaration"

Drawings

Block diagram

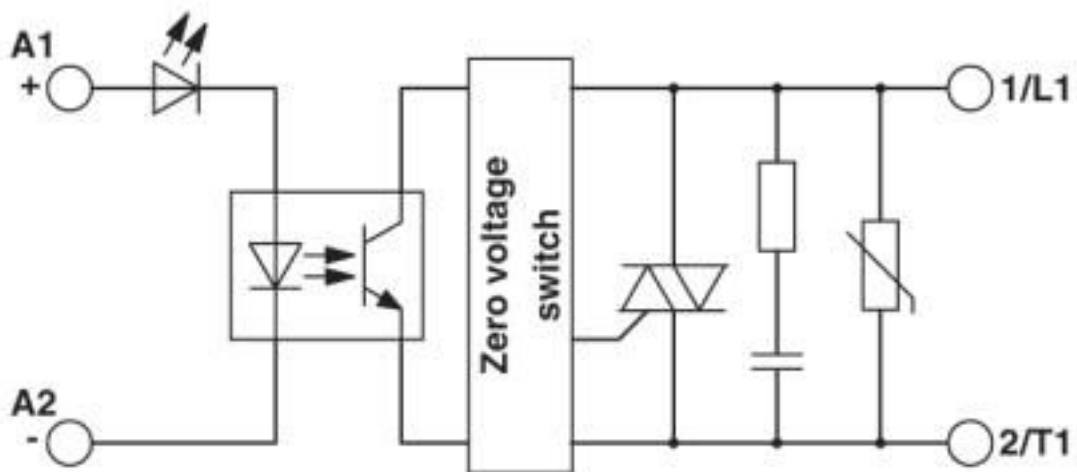

Solid-state contactor - ELR 1- 24DC/600AC-50 - 2297170

Diagram

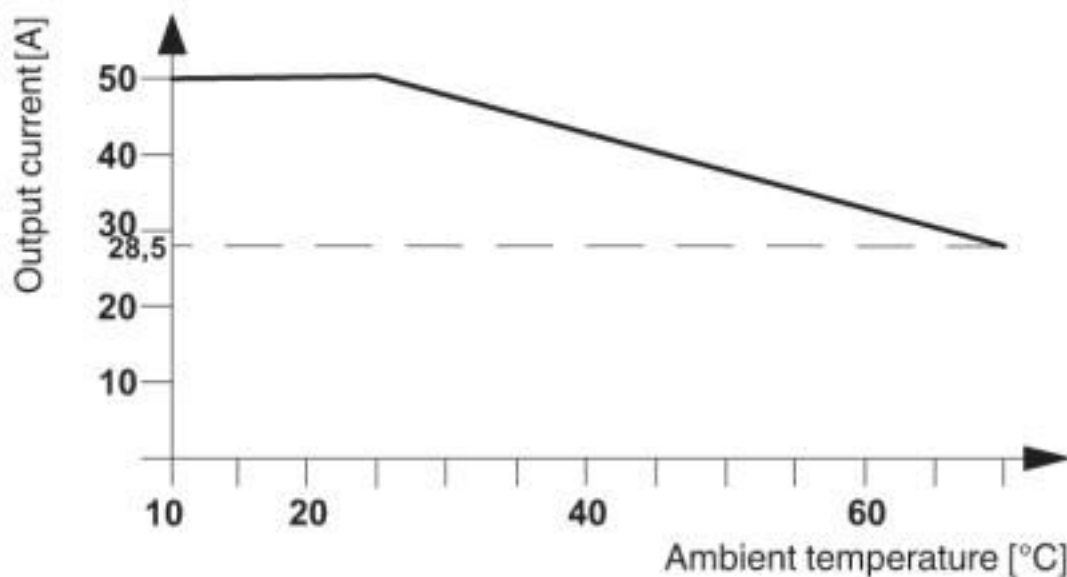

Classifications

eCl@ss

eCl@ss 4.0	27371100
eCl@ss 4.1	27371100
eCl@ss 5.0	27371000
eCl@ss 5.1	27371000
eCl@ss 6.0	27371000
eCl@ss 7.0	27371014
eCl@ss 8.0	27371014
eCl@ss 9.0	27371014

ETIM

ETIM 4.0	EC002055
ETIM 5.0	EC002055
ETIM 6.0	EC002055
ETIM 7.0	EC002055

UNSPSC

UNSPSC 6.01	30211915
UNSPSC 7.0901	39121514
UNSPSC 11	39121514
UNSPSC 12.01	39121514
UNSPSC 13.2	39121529
UNSPSC 19.0	39121529

Solid-state contactor - ELR 1- 24DC/600AC-50 - 2297170

Approvals





Approvals

Approvals

UL Recognized / cUL Recognized / EAC / cULus Recognized

Ex Approvals

Approval details

UL Recognized		http://database.ul.com/cgi-bin/XYV/template/LISEXT/1FRAME/index.htm	FILE E 195083
cUL Recognized		http://database.ul.com/cgi-bin/XYV/template/LISEXT/1FRAME/index.htm	FILE E 195083
EAC			RU C- DE.A*30.B.01082
cULus Recognized			

Phoenix Contact 2020 © - all rights reserved
<http://www.phoenixcontact.com>

PHOENIX CONTACT GmbH & Co. KG
Flachsmarktstr. 8
32825 Blomberg
Germany
Tel. +49 5235 300
Fax +49 5235 3 41200
<http://www.phoenixcontact.com>

X-ON Electronics

Largest Supplier of Electrical and Electronic Components

Click to view similar products for [Contactors - Solid State](#) category:

Click to view products by [Phoenix Contact](#) manufacturer:

Other Similar products are found below :

[SUL842070](#) [SUL867070](#) [SILD867170](#) [DRC3P48C411R2](#) [DRC3P48D433R](#) [DRC3R48E440](#) [GNR45DCZ](#) [DP4RSA60E40B2](#)
[DRA3P48D2R2](#) [DRA3P48E2R2](#) [DP4RSB60D60B](#) [DRC3P48D4002](#) [DP4RSC60E40B8](#) [DP4RSA60D40B8](#) [DRA3P48A4R](#) [DRC3R48A400](#)
[DRC3P60B4112](#) [DRA3P48D22](#) [DP4RSC60E60B2](#) [DP4RSC60E40B2](#) [DP4RSA60E40B8](#) [DP4RSA60E40B5](#) [DP4RSA60D40](#)
[DP4R60D60B5](#) [GNR20DCZ](#) [DP4R60D60](#) [DRA3R48E4](#) [DRC3P48D400R](#) [DRC3P48D400R2](#) [DRC3R48D420](#) [DRH3P60A18](#) [GNR30DCZ](#)
[SSC1000-25-12](#) [SSC1000-25-24](#) [SSC1000-25-36](#) [SS083-1Z-D5](#) [G3PE-215B DC12-24](#) [G3PE-235B DC12-24](#) [2297167](#) [2297183](#) [ELR 1-](#)
[230AC/600AC-30](#) [ELR 1-230AC/600AC-50](#) [ELR W3- 24DC/500AC- 9](#) [DRC3P60B411R](#) [DRC3R48E420](#) [DRC3P60D400](#) [DRC3P48A411R](#)
[GNR10DCZ](#) [GNR30DCR](#) [DRA3P48A4R2](#)