

Cable - VIP-CAB-FLK10/0,14/3,0M - 2318347

Please be informed that the data shown in this PDF Document is generated from our Online Catalog. Please find the complete data in the user's documentation. Our General Terms of Use for Downloads are valid (<http://phoenixcontact.com/download>)



Round cable set; connection 1: IDC/FLK socket strip (1x 10-position, 180 °-out put); connection 2: IDC/FLK socket strip (1x 10-position, 90 °-out put); cable length: 3 m

Your advantages

- ✓ Available in any choice of length
- ✓ 10 to 20-pos.
- ✓ Individual serial number
- ✓ Connector according to IEC 60603-13
- ✓ 1:1 connection

Key Commercial Data

Packing unit	1 pc
GTIN	 4 046356 311601
GTIN	4046356311601

Technical data

Ambient conditions

Ambient temperature (operation)	-40 °C ... 70 °C (fixed installation)
	-10 °C ... 70 °C (flexible installation)
Ambient temperature (storage/transport)	-40 °C ... 80 °C
Maximum altitude	≤ 2000 m
Degree of protection	IP00
	≥ IP54 (Installation location)

General

Max. permissible operating voltage	25 V AC
	60 V DC
Max. current carrying capacity per path	1 A (50 °C)
	0.6 A (70°C)

Cable - VIP-CAB-FLK10/0,14/3,0M - 2318347

Technical data

General

Length of cable	3 m
External cable diameter	6.1 mm ±0.4 mm
Single wire, cross section	0.14 mm ²
Single wire, cross section [AWG]	26
Single wire, number of litz wires	7
Single wire, material	Cu tin-plated
Wire diameter incl. insulation	1 mm ±0.03 mm
Smallest bending radius, fixed installation	52 mm
Smallest bending radius, movable installation	98 mm
Bending cycles	5000 (at a radius of ≥ 15x outside diameter)
Cable, preassembly	Insulation displacement, IEC 60352-4/DIN EN 60352-4
Shielding	no
Cable insulation resistance	≥ 20 MΩ/km (20 °C)
Cable resistance	≤ 145 Ω/km (20 °C)
Outer sheath, material	Semi-rigid PVC
External sheath, color	gray
Nominal operating mode	100% operating factor

Connection data

Connection name	Field level
Connection in acc. with standard	IEC 60603-13
Connection method	IDC/FLK socket strip
Number of connections	1
Number of positions	10
Exit angle	90 °
Insertion/withdrawal cycles	> 50
Pitch	2.54 mm

Connection data 2

Connection name	Controller level
Connection in acc. with standard	IEC 60603-13
Connection method	IDC/FLK socket strip
Number of connections	1
Number of positions	10
Exit angle	180 °
Insertion/withdrawal cycles	> 50
Pitch	2.54 mm

Standards and Regulations

Flame resistance	UL VW-1
	CSA FT-1
	IEC 60332-1-2

Cable - VIP-CAB-FLK10/0,14/3,0M - 2318347

Technical data

Standards and Regulations

	VDE 0842, Part 332-1-2
	IEC 60332-3-22
Resistance to oil	against occasional splashes
Gasoline resistance	against occasional splashes
Connection in acc. with standard	CUL
Designation	Air clearances and creepage distances
Standards/regulations	DIN EN 50178
Rated insulation voltage	63 V
Rated surge voltage	0.6 kV
Insulation	Functional insulation
Pollution degree	2
Overvoltage category	II

Supported controller

Controller	universal
------------	-----------

Environmental Product Compliance

China RoHS	Environmentally Friendly Use Period = 50 years
	For details about hazardous substances go to tab "Downloads", Category "Manufacturer's declaration"

Drawings

Diagram

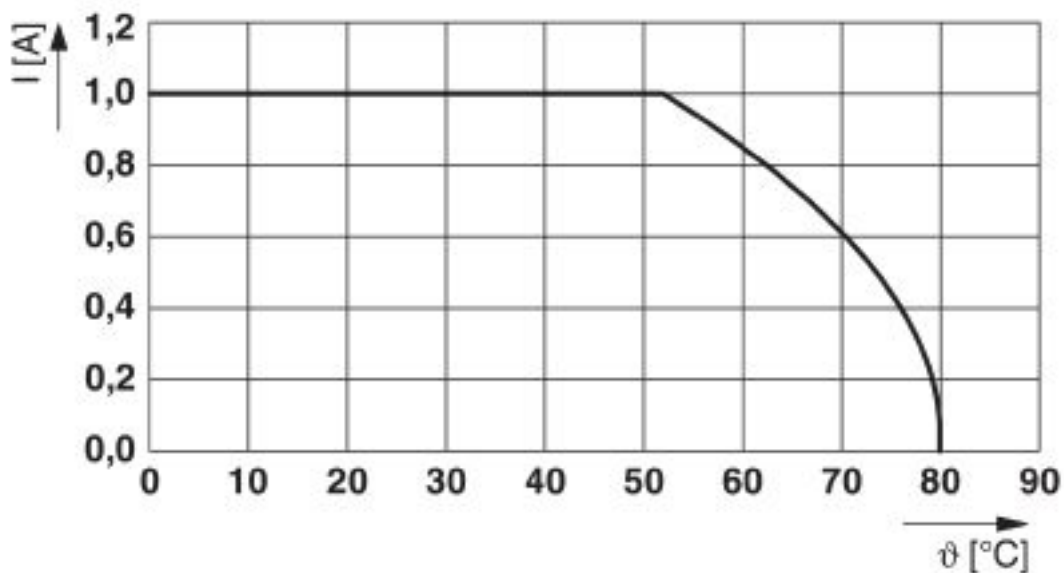

Maximum permissible current per path in uncoiled state

Cable - VIP-CAB-FLK10/0,14/3,0M - 2318347

Dimensional drawing

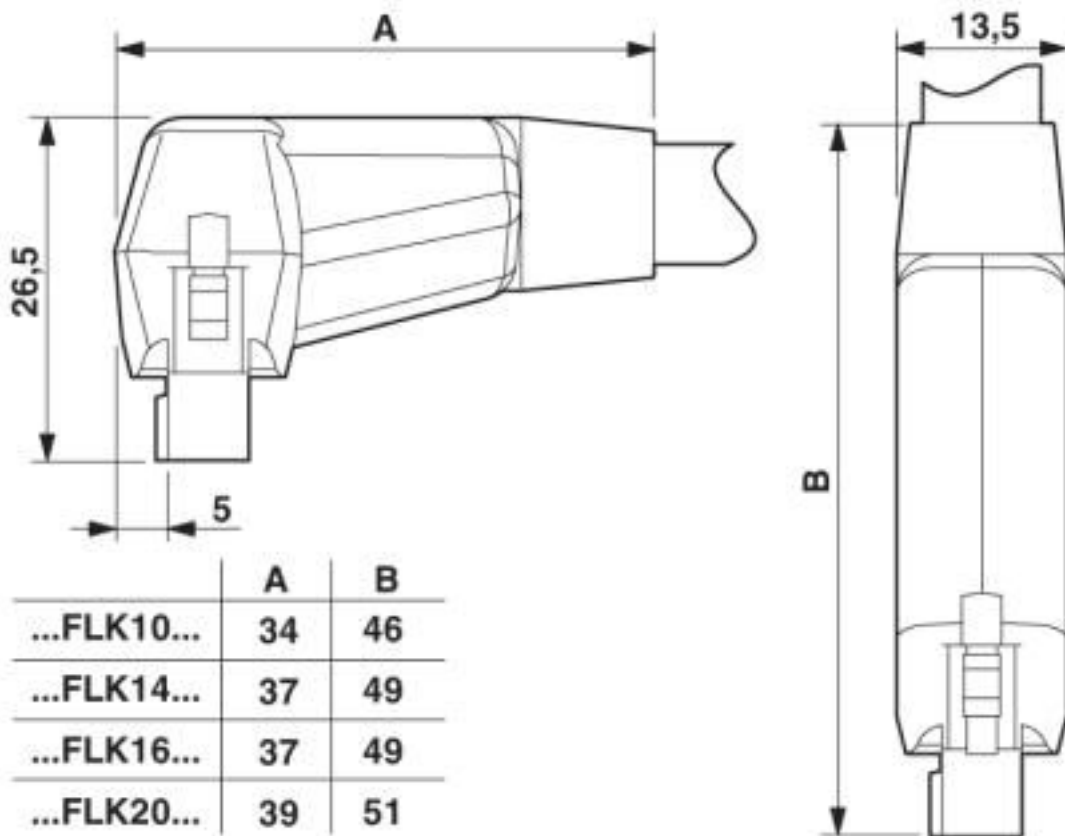

Classifications

eCl@ss

eCl@ss 10.0.1	27242220
eCl@ss 4.0	27060300
eCl@ss 4.1	27060300
eCl@ss 5.0	27242200
eCl@ss 5.1	27242200
eCl@ss 6.0	27249200
eCl@ss 7.0	27249205
eCl@ss 8.0	27249205
eCl@ss 9.0	27242220

ETIM

ETIM 2.0	EC000237
ETIM 3.0	EC000237
ETIM 4.0	EC000237
ETIM 5.0	EC000237
ETIM 6.0	EC000237

Cable - VIP-CAB-FLK10/0,14/3,0M - 2318347

Classifications

ETIM

ETIM 7.0	EC000237
----------	----------

UNSPSC

UNSPSC 6.01	26121620
UNSPSC 7.0901	26121620
UNSPSC 11	26121620
UNSPSC 12.01	26121620
UNSPSC 13.2	26121620
UNSPSC 18.0	26121620
UNSPSC 19.0	26121620
UNSPSC 20.0	26121620
UNSPSC 21.0	26121620

Approvals

Approvals

Approvals

UL Listed / cUL Listed / EAC / cULus Listed

Ex Approvals

Approval details

UL Listed		http://database.ul.com/cgi-bin/XYV/template/LISEXT/1FRAME/index.htm	FILE E 238705
Nominal voltage UN		125 V	
Nominal current IN		1 A	

cUL Listed		http://database.ul.com/cgi-bin/XYV/template/LISEXT/1FRAME/index.htm	FILE E 238705
Nominal voltage UN		125 V	
Nominal current IN		1 A	

Cable - VIP-CAB-FLK10/0,14/3,0M - 2318347

Approvals

EAC		RU* DE.HB*35.B00385
-----	---	------------------------

cULus Listed	
--------------	---

Accessories

Accessories

Marker carrier cable

Cable marker carrier - KME - 0807083



Cable marker carrier, white, unlabeled, mounting type: Assembly with cable binders, cable diameter: > 5 mm, lettering field size: 20 mm x 8 mm

Phoenix Contact 2020 © - all rights reserved
<http://www.phoenixcontact.com>

PHOENIX CONTACT GmbH & Co. KG
Flachsmarktstr. 8
32825 Blomberg
Germany
Tel. +49 5235 300
Fax +49 5235 3 41200
<http://www.phoenixcontact.com>

X-ON Electronics

Largest Supplier of Electrical and Electronic Components

Click to view similar products for [Ribbon Cables / IDC Cables](#) category:

Click to view products by [Phoenix Contact](#) manufacturer:

Other Similar products are found below :

[FSK-12A](#) [AWG28-10G](#) [EHJ3C](#) [EHJ4C](#) [cab-LVDV-PWR-10-15](#) [FSP-25A](#) [3365/15 \(100FT\)](#) [cab-LVDV-DAT-34-15](#) [49635-C62-S2](#) [1-3636-600-5204](#) [92315-1408](#) [426171120-3](#) [3625/08 \(100M\)](#) [0044704](#) [2-1589735-3](#) [JSM015PP2DCC23N](#) [92301-0283](#) [ACL-eSSI-2](#) [92301-0718](#) [MMSDT-06-20-S-05.5-D-K-LDX](#) [IDD-04-G](#) [NM-2J2-051-PS1-JJAB](#) [1700/14SF \(100FT\)](#) [1700/26SF \(100FT\)](#) [1700/34SF \(100FT\)](#) [3801/09 \(100FT\)](#) [119-885](#) [DS1057-06A282R-30.5](#) [DS1057-09A282R-30.5](#) [DS1057-12A282R-30.5](#) [DS1057-14A282R-76.5](#) [DS1057-20A282R-76.5](#) [DS1057-30A282R-76.5](#) [DS1057-34A282R-76.5](#) [DS1057-40A282R-76.5](#) [DS1057-60A282R-76.5](#) [DS1057-64A282R-76.5](#) [DS1058-08M28-30.5](#) [DS1058-30M28-30.5](#) [3750/10 \(100FT\)](#) [0015712](#) [0015905](#) [S30109](#) [11203](#) [11223](#) [11243](#) [11262](#) [0037147](#) [0022512](#) [0022412](#)