

Cable - VIP-CAB-FLK26/0,14/3,0M - 2318664

Please be informed that the data shown in this PDF Document is generated from our Online Catalog. Please find the complete data in the user's documentation. Our General Terms of Use for Downloads are valid (<http://phoenixcontact.com/download>)



Round cable set; connection 1: IDC/FLK socket strip (1x 26-position, 180 °-out put); connection 2: IDC/FLK socket strip (1x 26-position, 90 °-out put); cable length: 3 m

Your advantages

- Available in any choice of length
- 26 to 50-pos.
- Individual serial number
- Connector according to IEC 60603-13
- 1:1 connection

Key Commercial Data

Packing unit	1 pc
GTIN	 4 046356 312189
GTIN	4046356312189

Technical data

Ambient conditions

Ambient temperature (operation)	-20 °C ... 50 °C
Ambient temperature (storage/transport)	-20 °C ... 70 °C

General

Max. permissible operating voltage	25 V AC
	60 V DC
Max. current carrying capacity per path	1 A
Length of cable	3 m
External cable diameter	8.3 mm
Single wire, cross section	0.14 mm ²
Single wire, cross section [AWG]	26
Single wire, number of litz wires	7

Cable - VIP-CAB-FLK26/0,14/3,0M - 2318664

Technical data

General

Single wire, material	Cu tin-plated
Cable, preassembly	Insulation displacement, IEC 60352-4/DIN EN 60352-4
Shielding	no
Cable capacity	120 pF/m
Outer sheath, material	PVC
External sheath, color	gray RAL 7035

Connection data

Connection name	Field level
Connection method	IDC/FLK socket strip
Number of connections	1
Number of positions	26
Exit angle	90 °
Pitch	2.54 mm

Connection data 2

Connection name	Controller level
Connection method	IDC/FLK socket strip
Number of connections	1
Number of positions	26
Exit angle	180 °
Pitch	2.54 mm

Standards and Regulations

Flame resistance	IEC 60332-1
	DIN VDE 0482 Part 332-1
Resistance to oil	UL 1581
Gasoline resistance	against occasional splashes
Connection in acc. with standard	CUL

Supported controller

Controller	universal
------------	-----------

Environmental Product Compliance

China RoHS	Environmentally Friendly Use Period = 50 years
	For details about hazardous substances go to tab "Downloads", Category "Manufacturer's declaration"

Drawings

Cable - VIP-CAB-FLK26/0,14/3,0M - 2318664

Dimensional drawing

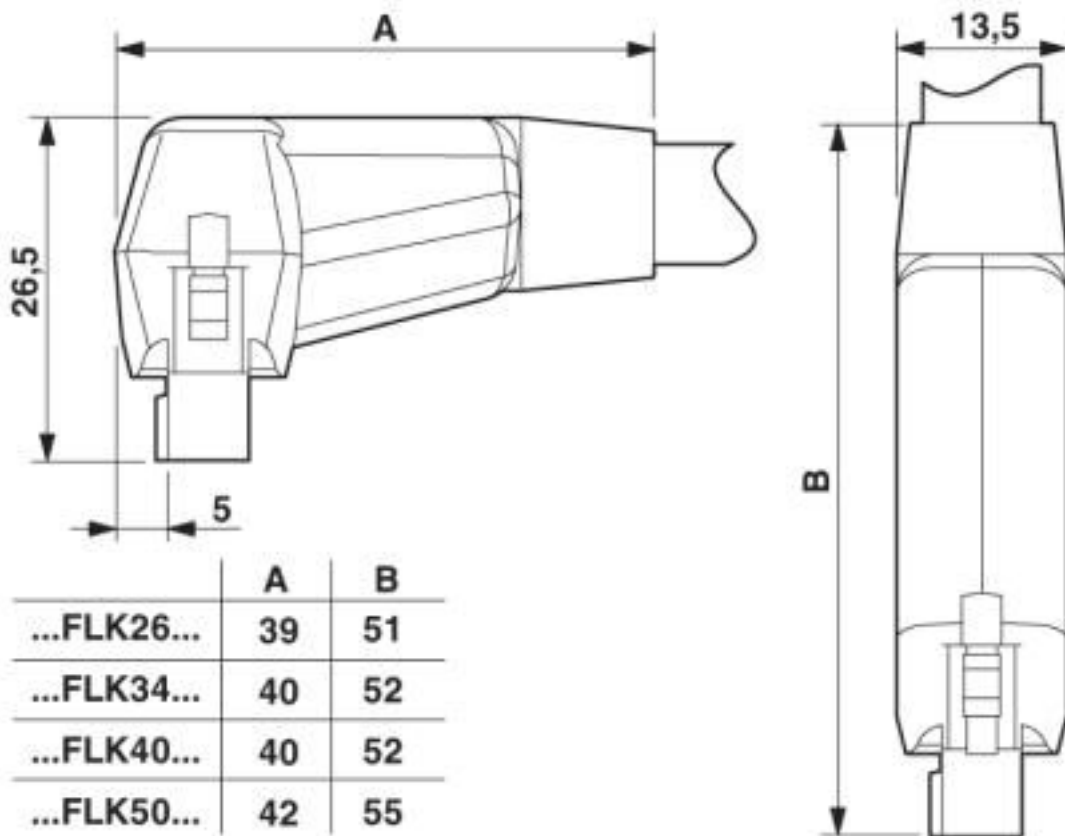

Classifications

eCl@ss

eCl@ss 10.0.1	27242220
eCl@ss 4.0	27060300
eCl@ss 4.1	27060300
eCl@ss 5.0	27242200
eCl@ss 5.1	27242200
eCl@ss 6.0	27249200
eCl@ss 7.0	27249205
eCl@ss 8.0	27249205
eCl@ss 9.0	27242220

ETIM

ETIM 2.0	EC000237
ETIM 3.0	EC000237
ETIM 4.0	EC000237
ETIM 5.0	EC000237
ETIM 6.0	EC000237

Cable - VIP-CAB-FLK26/0,14/3,0M - 2318664

Classifications

ETIM

ETIM 7.0	EC000237
----------	----------

UNSPSC

UNSPSC 6.01	26121620
UNSPSC 7.0901	26121620
UNSPSC 11	26121620
UNSPSC 12.01	26121620
UNSPSC 13.2	26121620
UNSPSC 18.0	26121620
UNSPSC 19.0	26121620
UNSPSC 20.0	26121620
UNSPSC 21.0	26121620

Approvals

Approvals

Approvals

UL Listed / cUL Listed / EAC / cULus Listed

Ex Approvals

Approval details

UL Listed		http://database.ul.com/cgi-bin/XYV/template/LISEXT/1FRAME/index.htm	FILE E 238705
Nominal voltage UN	125 V		
Nominal current IN	1 A		

cUL Listed		http://database.ul.com/cgi-bin/XYV/template/LISEXT/1FRAME/index.htm	FILE E 238705
Nominal voltage UN	125 V		
Nominal current IN	1 A		

Cable - VIP-CAB-FLK26/0,14/3,0M - 2318664

Approvals

EAC		RU* DE.HB*35.B00385
-----	---	------------------------

cULus Listed		
--------------	---	--

Phoenix Contact 2020 © - all rights reserved
<http://www.phoenixcontact.com>

PHOENIX CONTACT GmbH & Co. KG
Flachsmarktstr. 8
32825 Blomberg
Germany
Tel. +49 5235 300
Fax +49 5235 3 41200
<http://www.phoenixcontact.com>

X-ON Electronics

Largest Supplier of Electrical and Electronic Components

Click to view similar products for [Ribbon Cables / IDC Cables](#) category:

Click to view products by [Phoenix Contact](#) manufacturer:

Other Similar products are found below :

[FSK-12A](#) [AWG28-10G](#) [EHJ3C](#) [EHJ4C](#) [cab-LVDV-PWR-10-15](#) [FSP-25A](#) [3365/15 \(100FT\)](#) [cab-LVDV-DAT-34-15](#) [49635-C62-S2](#) [1-3636-600-5204](#) [92315-1408](#) [426171120-3](#) [3625/08 \(100M\)](#) [0044704](#) [2-1589735-3](#) [JSM015PP2DCC23N](#) [92301-0283](#) [ACL-eSSI-2](#) [92301-0718](#) [MMSDT-06-20-S-05.5-D-K-LDX](#) [IDD-04-G](#) [NM-2J2-051-PS1-JJAB](#) [1700/14SF \(100FT\)](#) [1700/26SF \(100FT\)](#) [1700/34SF \(100FT\)](#) [3801/09 \(100FT\)](#) [119-885](#) [DS1057-06A282R-30.5](#) [DS1057-09A282R-30.5](#) [DS1057-12A282R-30.5](#) [DS1057-14A282R-76.5](#) [DS1057-20A282R-76.5](#) [DS1057-30A282R-76.5](#) [DS1057-34A282R-76.5](#) [DS1057-40A282R-76.5](#) [DS1057-60A282R-76.5](#) [DS1057-64A282R-76.5](#) [DS1058-08M28-30.5](#) [DS1058-30M28-30.5](#) [3750/10 \(100FT\)](#) [0015712](#) [0015905](#) [S30109](#) [11203](#) [11223](#) [11243](#) [11262](#) [0037147](#) [0022512](#) [0022412](#)