

Uninterruptible power supply - QUINT4-UPS/1AC/1AC/1KVA - 2320283

Please be informed that the data shown in this PDF Document is generated from our Online Catalog. Please find the complete data in the user's documentation. Our General Terms of Use for Downloads are valid (<http://phoenixcontact.com/download>)



Uninterruptible power supply with IQ technology for DIN rail mounting. Input: 120/230 V AC, output: 120/230 V AC/1 kVA. Provides information regarding the state of charge, remaining runtime, and service life of the rechargeable battery module at any time, thereby increasing system availability.

Product Description

Supply AC loads reliably with the uninterruptible power supply from the QUINT range for DIN rails. Due to the online topology, the AC UPS delivers a pure sine curve in mains and battery operation. Combine the online UPS with various UPS-BAT energy storage devices. The USB interface makes it convenient to shut down your PC.

Your advantages

- Smooth transition due to online topology
- Pure sine curve in mains and battery operation
- USB interface for connecting to industrial PCs, for example
- Startup from energy storage possible, even without mains input
- Can be switched in parallel for redundancy and increased performance



Key Commercial Data

Packing unit	1 pc
GTIN	
GTIN	4055626244563

Technical data

Dimensions

Width	290 mm
Height	130 mm
Depth	125 mm
Installation distance right/left	5 mm / 5 mm
Installation distance top/bottom	50 mm / 50 mm

Ambient conditions

Degree of protection	IP20
Ambient temperature (operation)	-25 °C ... 60 °C (> 50 °C Derating: 2.5 %/K)

Uninterruptible power supply - QUINT4-UPS/1AC/1AC/1KVA - 2320283

Technical data

Ambient conditions

Ambient temperature (storage/transport)	-40 °C ... 85 °C (with charged energy storage device)
Max. permissible relative humidity (operation)	≤ 95 %
Climatic class	3K3 (EN 60721)
Installation height	≤ 3000 m (> 2000 m, observe derating)

Input data

Nominal input voltage	100 V AC -10 % / +20 %
	110 V AC -10 % / +20 %
	120 V AC -10 % / +20 %
	130 V AC -10 % / +20 %
	200 V AC -20 % / +20 %
	210 V AC -20 % / +20 %
	220 V AC -20 % / +20 %
	230 V AC -20 % / +15 %
	240 V AC -20 % / +10 %
Input voltage range	90 V AC ... 264 V AC
AC frequency range	45 Hz ... 65 Hz
Buffer period	1 h (38 AH)
Permissible backup fuse	B16 230 V AC
Power factor (cos phi)	0.9

Output data

Nominal output voltage	100 V AC
	110 V AC
	120 V AC
	130 V AC
	200 V AC
	210 V AC
	220 V AC
	230 V AC
	240 V AC
Nominal output current (I _N)	7.8 A (100 V AC)
	8.1 A (110 V AC)
	8.3 A (120 V AC)
	7.7 A (130 V AC)
	5 A (200 V AC)
	4.8 A (210 V AC)
	4.5 A (220 V AC)
	4.3 A (230 V AC)
	4.2 A (240 V AC)
POWER BOOST (I _{Boost})	13 A (120 V AC)
	7 A (230 V AC)

Uninterruptible power supply - QUINT4-UPS/1AC/1AC/1KVA - 2320283

Technical data

Output data

Derating	> 50 °C ... 60 °C (2.5%/K)
Connection in parallel	Yes, 2
Connection in series	No
Maximum power dissipation in no-load condition	typ. 17 W (120 V AC)
	typ. 25 W (230 V AC)

General

Net weight	5 kg
Efficiency	> 92 % (120 V AC)
	> 94 % (230 V AC)
MTBF (IEC 61709, SN 29500)	217546 h (230 V AC, at 40 °C)
Degree of protection	IP20
Protection class	I

Connection data, input

Connection method	Screw connection
Conductor cross section solid min.	0.2 mm ²
Conductor cross section solid max.	6 mm ²
Conductor cross section flexible min.	0.2 mm ²
Conductor cross section flexible max.	4 mm ²
Conductor cross section AWG min.	30
Conductor cross section AWG max.	10
Stripping length	8 mm

Connection data, output

Connection method	Screw connection
Conductor cross section solid min.	0.2 mm ²
Conductor cross section solid max.	6 mm ²
Conductor cross section flexible min.	0.2 mm ²
Conductor cross section flexible max.	4 mm ²
Conductor cross section AWG min.	30
Conductor cross section AWG max.	10
Stripping length	8 mm

Connection data for signaling

Connection method	Screw connection
Conductor cross section solid min.	0.2 mm ²
Conductor cross section solid max.	2.5 mm ²
Conductor cross section flexible min.	0.2 mm ²
Conductor cross section flexible max.	2.5 mm ²
Conductor cross section AWG min.	30
Conductor cross section AWG max.	12
Stripping length	8 mm

Uninterruptible power supply - QUINT4-UPS/1AC/1AC/1KVA - 2320283

Technical data

Standards

Standard designation	Uninterruptible power supply systems
Standards/regulations	EN 62040-1

EMC data

Electromagnetic compatibility	Conformance with EMC Directive 2014/30/EU
Low Voltage Directive	Conformance with Low Voltage Directive 2014/35/EC
Electrostatic discharge	EN 61000-4-2
Contact discharge	± 6 kV
Discharge in air	± 8 kV
Electromagnetic HF field	EN 61000-4-3
Frequency range	80 MHz ... 6 GHz
Test field strength	10 V/m
Comments	Criterion A
Fast transients (burst)	EN 61000-4-4
Input	± 2 kV
	± 2 kV
Output	± 2 kV
Signal	± 2 kV
	± 2 kV (USB)
Comments	Criterion A (B for USB)
Surge voltage load (surge)	EN 61000-4-5
Signal	1 kV (asymmetrical)
Comments	Criterion A
Conducted interference	EN 61000-4-6
Frequency range	0.15 MHz ... 80 MHz
Voltage	10 V
Comments	Criterion A
Power frequency magnetic field	EN 61000-4-8
Frequency	50 Hz
	60 Hz
Test field strength	100 A/m
Comments	Criterion A
Criterion A	Normal operating behavior within the specified limits.
Criterion B	Temporary impairment to operational behavior that is corrected by the device itself.

Environmental Product Compliance

REACH SVHC	Lead 7439-92-1
------------	----------------

Drawings

Uninterruptible power supply - QUINT4-UPS/1AC/1AC/1KVA - 2320283

Block diagram

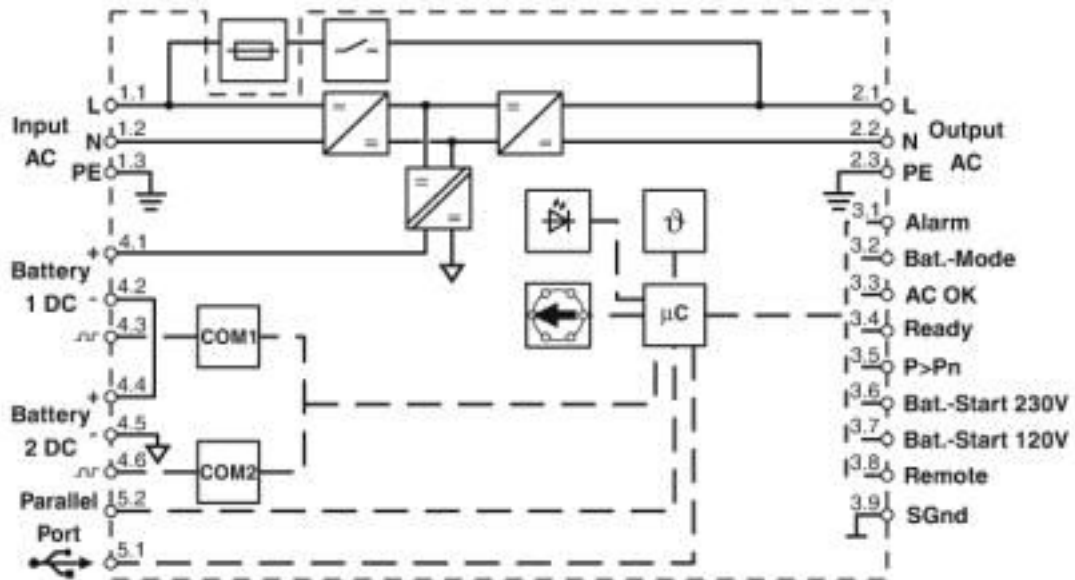

Diagram

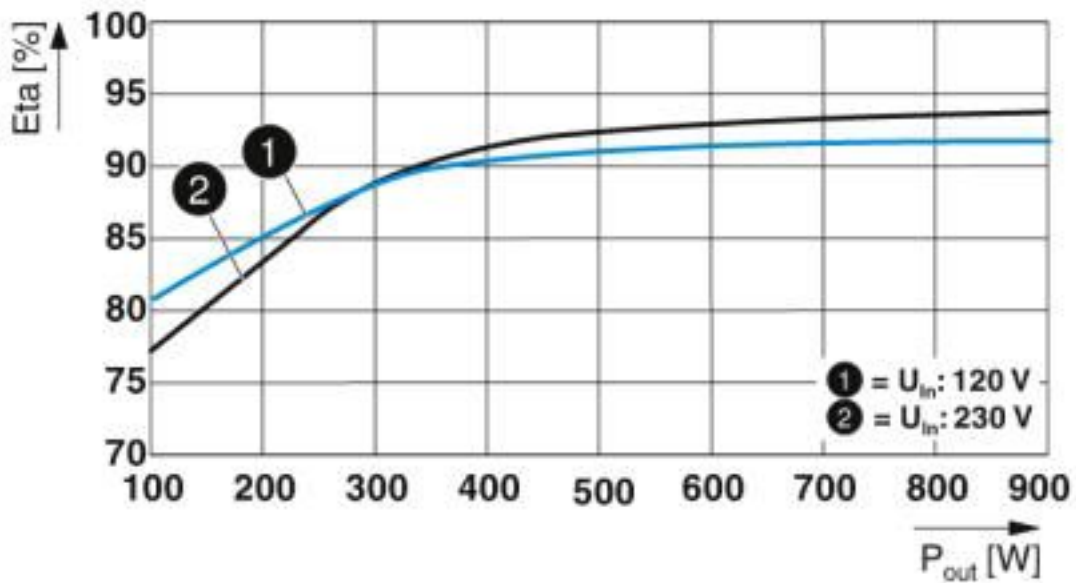

Classifications

eCl@ss

eCl@ss 10.0.1	27040705
eCl@ss 5.1	27040603
eCl@ss 6.0	27040600
eCl@ss 7.0	27040602
eCl@ss 8.0	27040602

Uninterruptible power supply - QUINT4-UPS/1AC/1AC/1KVA - 2320283

Classifications

eCl@ss

eCl@ss 9.0	27040705
------------	----------

ETIM

ETIM 5.0	EC000382
ETIM 6.0	EC000382
ETIM 7.0	EC000382

Approvals





Approvals

Approvals

UL Recognized / cUL Recognized / IECCEB Scheme / EAC / DNV GL / cULus Recognized

Ex Approvals

Approval details

UL Recognized		http://database.ul.com/cgi-bin/XYV/template/LISEXT/1FRAME/index.htm	FILE E 342453
cUL Recognized		http://database.ul.com/cgi-bin/XYV/template/LISEXT/1FRAME/index.htm	FILE E 342453
IECEE CB Scheme		http://www.iecee.org/	DK-70737-UL
EAC			RU*DE*08.B.01873/19
DNV GL		https://approvalfinder.dnvgl.com/	TAA00002JM

Uninterruptible power supply - QUINT4-UPS/1AC/1AC/1KVA - 2320283

Approvals

cULus Recognized



Accessories

Accessories

Assembly adapter

Assembly adapters - UWA 130 - 2901664



2-piece universal wall adapter for securely mounting the device in the event of strong vibrations. The profiles that are screwed onto the side of the device are screwed directly onto the mounting surface. The universal wall adapter is attached on the left/right.

Battery unit

Energy storage - UPS-BAT/VRLA/24DC/3.4AH - 2320306



Energy storage device, lead AGM, VRLA technology, 24 V DC, 3.4 Ah, tool-free battery replacement, automatic detection, and communication with QUINT UPS-IQ

Energy storage - UPS-BAT/VRLA/24DC/7.2AH - 2320319



Energy storage device, lead AGM, VRLA technology, 24 V DC, 7.2 Ah, tool-free battery replacement, automatic detection, and communication with QUINT UPS-IQ

Energy storage - UPS-BAT/VRLA/24DC/12AH - 2320322



Energy storage device, lead AGM, VRLA technology, 24 V DC, 12 Ah, tool-free battery replacement, automatic detection, and communication with QUINT UPS-IQ

Uninterruptible power supply - QUINT4-UPS/1AC/1AC/1KVA - 2320283

Accessories

Energy storage - UPS-BAT/VRLA/24DC/38AH - 2320335



Energy storage device, lead AGM, VRLA technology, 24 V DC, 38 Ah, automatic detection, and communication with QUINT UPS-IQ

Energy storage - UPS-BAT/VRLA-WTR/24DC/13AH - 2320416



Energy storage device, lead AGM, VRLA technology, 24 V DC, 13 Ah, tool-free battery replacement, automatic detection, and communication with QUINT UPS-IQ

Energy storage - UPS-BAT/VRLA-WTR/24DC/26AH - 2320429



Energy storage device, lead AGM, VRLA technology, 24 V DC, 26 Ah, tool-free battery replacement, automatic detection, and communication with QUINT UPS-IQ

Energy storage - UPS-BAT/LI-ION/24DC/120WH - 2320351



Energy storage device, LI-ION technology, 24 V DC, 120 Wh, for ambient temperatures of -20°C ... 60°C, automatic detection and communication with QUINT UPS-IQ

Energy storage - UPS-BAT/LI-ION/24DC/924WH - 2908232



Energy storage device, LI-ION technology, 24 V DC, 924 Wh, for ambient temperatures of -25 °C ... 60 °C, automatic detection and communication with QUINT UPS-IQ

Data cable preassembled

Uninterruptible power supply - QUINT4-UPS/1AC/1AC/1KVA - 2320283

Accessories

Data cable - MINI-SCREW-USB-DATACABLE - 2908217



Used for communication between an industrial PC and Phoenix Contact devices with USB-Mini-B connection.

Patch cable - VS-IP20/10G-IP20/10G-94F/1 - 1418866



Patch cable, CAT6_A, 4-pair, shielded, connection not crossed (Line), assembled at both ends with RJ45/IP20 connectors; outer sheath material: PUR; length: 1.0 m

Device protection

Type 3 surge protection device - PLT-SEC-T3-120-FM-UT - 2907918



Type 2/3 surge protection, consisting of protective plug and base element, with integrated status indicator and remote signaling for single-phase power supply networks. Nominal voltage 120 V AC/DC.

Type 3 surge protection device - PLT-SEC-T3-230-FM-UT - 2907919



Type 2/3 surge protection, consisting of protective plug and base element with screw connection. For single-phase power supply network with integrated status indicator and remote signaling. Nominal voltage 230 V AC/DC.

Fuse

Fuse - FUSE 25A/58V TAC ATO - 1021340



Fuse, nominal current: 25 A,

Phoenix Contact 2020 © - all rights reserved
<http://www.phoenixcontact.com>

PHOENIX CONTACT GmbH & Co. KG
Flachmarktstr. 8
32825 Blomberg
Germany
Tel. +49 5235 300
Fax +49 5235 3 41200
<http://www.phoenixcontact.com>

X-ON Electronics

Largest Supplier of Electrical and Electronic Components

Click to view similar products for [DIN Rail Power Supplies](#) category:

Click to view products by [Phoenix Contact](#) manufacturer:

Other Similar products are found below :

[PS-S6024](#) [DVP01PU-S](#) [DVP06AD-S](#) [DVP06XA-S](#) [DVDPNET-SL](#) [DVPDT01-S](#) [DVPPS01](#) [PS-6012](#) [PS9Z-5R1G](#) [PS-C24024](#)
[DVP08ST11N](#) [DVPACAB530](#) [DVPCOPM-SL](#) [DVPEN01-SL](#) [DVPPF01-S](#) [ADNB008-48-1PM-C](#) [ADNB017-24-1PM-C](#) [ADNB040-24-1PM-C](#) [ADNB034-12-1PM-C](#) [SS14011524](#) [PS-UPS40](#) [PSC-6024](#) [PSD-A60W12](#) [96PS-A120WDIN](#) [PSD-A60W48](#) [PSD-A40W12](#) [PSD-A40W24](#) [SMP21-L20-DC24V-5A](#) [PSD-A40W48](#) [S8T-DCBU-02](#) [PS-S4024](#) [NTPS-24-1.3](#) [ZI-20](#) [PST-96024](#) [S82YVSC4P](#) [PS-S4005](#) [PS-10024](#) [PS-S10024](#) [PS-C12024](#) [PSP-480S24](#) [PS-C48024](#) [PSC-2024](#) [PSC-4012](#) [PSC-4048](#) [PSC-9615](#) [PSC-15124](#) [PSC-15148](#) [PSC-24148](#) [PSC-48148](#) [TRIO-PS-2G/1AC/12DC/5/C2LP](#)