

## Interface module - VIP-2/SC/D15SUB/M/LED - 2322155

Please be informed that the data shown in this PDF Document is generated from our Online Catalog. Please find the complete data in the user's documentation. Our General Terms of Use for Downloads are valid (<http://phoenixcontact.com/download>)



VARIOFACE module, with screw connection and D-Subminiature pin strip, for mounting on NS 35 rails, with LED, 15-pos.

### Your advantages

- 9 to 50-pos.
- Metal foot
- According to IEC 60603-13
- 1:1 connection
- Screw connection



### Key Commercial Data

Packing unit	1 pc
GTIN	 4 046356 451772
GTIN	4046356451772

### Technical data

#### Dimensions

Width	50 mm
Height	65.5 mm
Depth	45.1 mm

#### Ambient conditions

Ambient temperature (operation)	-20 °C ... 50 °C
Ambient temperature (storage/transport)	-20 °C ... 70 °C

#### General

Nominal voltage $U_N$	24 V DC
Max. perm. current (per branch)	2.5 A
Number of positions	15

## Interface module - VIP-2/SC/D15SUB/M/LED - 2322155

### Technical data

#### General

Status display	LED
Mounting position	any

#### Connection data

Connection name	Field level
Connection in acc. with standard	IEC / EN
Connection method	Screw connection
Stripping length	8 mm
Screw thread	M3
Conductor cross section solid	0.2 mm <sup>2</sup> ... 4 mm <sup>2</sup>
Conductor cross section flexible	0.2 mm <sup>2</sup> ... 2.5 mm <sup>2</sup>
Conductor cross section AWG	24 ... 12

#### Connection data 2

Connection name	Controller level
Connection method	D-SUB pin strip
Number of connections	1
Number of positions	15

#### Standards and Regulations

Connection in acc. with standard	CUL
Standards/regulations	IEC 60664
	DIN EN 50178
Pollution degree	2
Overvoltage category	II
Flammability rating according to UL 94	V0

#### Environmental Product Compliance

REACH SVHC	Lead 7439-92-1
China RoHS	Environmentally Friendly Use Period = 50 years
	For details about hazardous substances go to tab "Downloads", Category "Manufacturer's declaration"

### Drawings

# Interface module - VIP-2/SC/D15SUB/M/LED - 2322155

Dimensional drawing

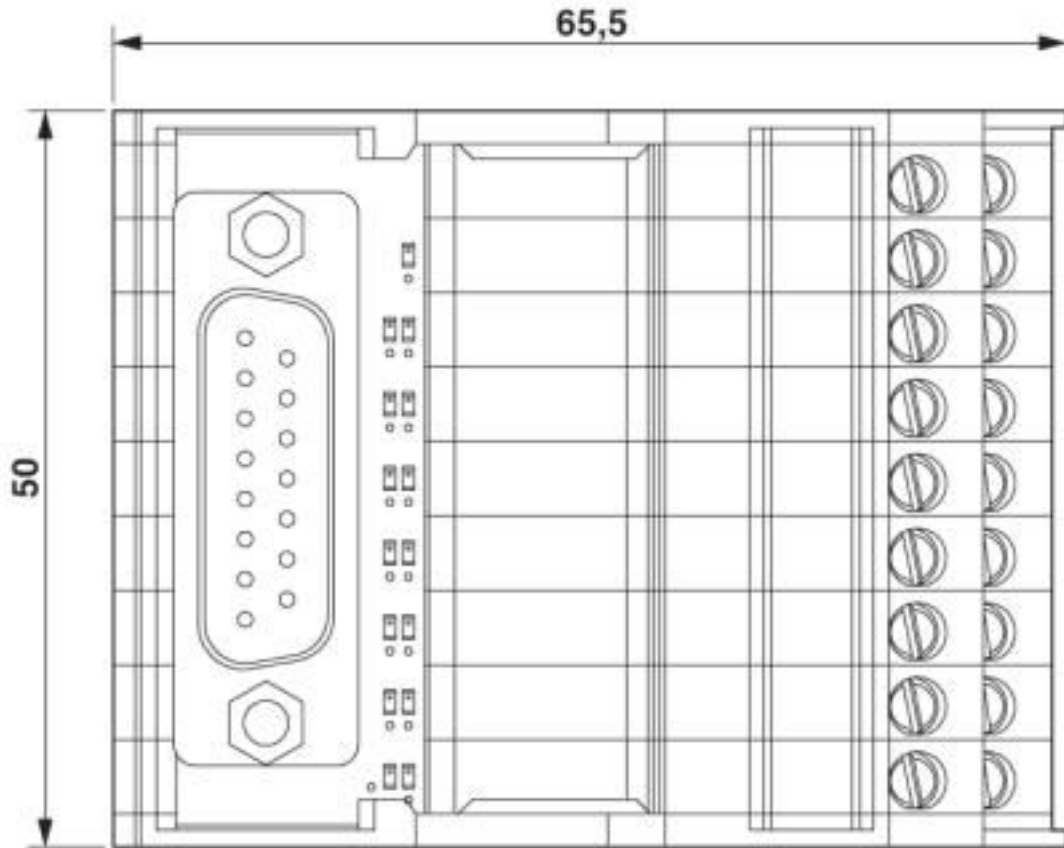

Circuit diagram

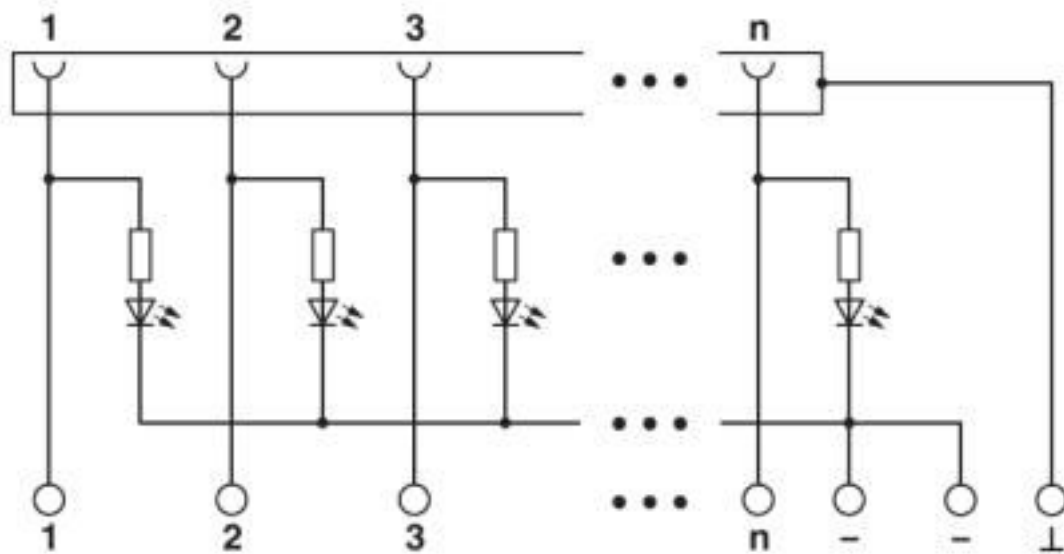

# Interface module - VIP-2/SC/D15SUB/M/LED - 2322155

## Classifications

### eCl@ss

eCl@ss 10.0.1	27141152
eCl@ss 4.0	27250300
eCl@ss 4.1	27250300
eCl@ss 5.0	27250300
eCl@ss 5.1	27250300
eCl@ss 6.0	27242600
eCl@ss 7.0	27141152
eCl@ss 8.0	27141152
eCl@ss 9.0	27141152

### ETIM

ETIM 4.0	EC002780
ETIM 5.0	EC002780
ETIM 6.0	EC002780
ETIM 7.0	EC002780

### UNSPSC

UNSPSC 6.01	30211824
UNSPSC 7.0901	39121421
UNSPSC 11	39121421
UNSPSC 12.01	39121421
UNSPSC 13.2	39121432
UNSPSC 18.0	39121432
UNSPSC 19.0	39121432
UNSPSC 20.0	39121432
UNSPSC 21.0	39121432

## Approvals

### Approvals

---

#### Approvals

CSA / UL Recognized / cUL Recognized / EAC / CSAus / cULus Recognized / cCSAus

---

#### Ex Approvals

---

### Approval details

# Interface module - VIP-2/SC/D15SUB/M/LED - 2322155

## Approvals

CSA		<a href="http://www.csagroup.org/services-industries/product-listing/">http://www.csagroup.org/services-industries/product-listing/</a>	2122203
Nominal voltage UN		24 V	
Nominal current IN		2 A	
mm <sup>2</sup> /AWG/kcmil		28-12	

UL Recognized		<a href="http://database.ul.com/cgi-bin/XYV/template/LISEXT/1FRAME/index.htm">http://database.ul.com/cgi-bin/XYV/template/LISEXT/1FRAME/index.htm</a>	FILE E 238705
Nominal voltage UN		24 V	
Nominal current IN		2 A	
mm <sup>2</sup> /AWG/kcmil		30-12	

cUL Recognized		<a href="http://database.ul.com/cgi-bin/XYV/template/LISEXT/1FRAME/index.htm">http://database.ul.com/cgi-bin/XYV/template/LISEXT/1FRAME/index.htm</a>	FILE E 238705
Nominal voltage UN		24 V	
Nominal current IN		2 A	
mm <sup>2</sup> /AWG/kcmil		30-12	

EAC		RU C- DE.A*30.B.01742
-----	---	--------------------------

CSAus		<a href="http://www.csagroup.org/services-industries/product-listing/">http://www.csagroup.org/services-industries/product-listing/</a>	2122203
Nominal voltage UN		24 V	
Nominal current IN		2 A	
mm <sup>2</sup> /AWG/kcmil		28-12	

cULus Recognized	
------------------	---

## Interface module - VIP-2/SC/D15SUB/M/LED - 2322155

### Approvals

cCSAus



### Accessories

#### Accessories

#### System cable

Cable - CABLE-D15SUB/B/S/ 50/KONFEK/S - 2302052



Assembled shielded round cable; connection 1: D-SUB socket strip (1x 15-position); connection 2: D-SUB pin strip (1x 15-position); cable length: 0.5 m

Cable - CABLE-D15SUB/B/S/100/KONFEK/S - 2302065



Assembled shielded round cable; connection 1: D-SUB socket strip (1x 15-position); connection 2: D-SUB pin strip (1x 15-position); cable length: 1 m

Cable - CABLE-D15SUB/B/S/150/KONFEK/S - 2302078



Assembled shielded round cable; connection 1: D-SUB socket strip (1x 15-position); connection 2: D-SUB pin strip (1x 15-position); cable length: 1.5 m

Cable - CABLE-D15SUB/B/S/200/KONFEK/S - 2302081



Assembled shielded round cable; connection 1: D-SUB socket strip (1x 15-position); connection 2: D-SUB pin strip (1x 15-position); cable length: 2 m

## Interface module - VIP-2/SC/D15SUB/M/LED - 2322155

### Accessories

Cable - CABLE-D15SUB/B/S/300/KONFEK/S - 2302094



Assembled shielded round cable; connection 1: D-SUB socket strip (1x 15-position); connection 2: D-SUB pin strip (1x 15-position); cable length: 3 m

---

Cable - CABLE-D15SUB/B/S/400/KONFEK/S - 2302104



Assembled shielded round cable; connection 1: D-SUB socket strip (1x 15-position); connection 2: D-SUB pin strip (1x 15-position); cable length: 4 m

---

Cable - CABLE-D15SUB/B/S/600/KONFEK/S - 2302117



Assembled shielded round cable; connection 1: D-SUB socket strip (1x 15-position); connection 2: D-SUB pin strip (1x 15-position); cable length: 6 m

---

Cable - CABLE D-SUB-S/.../.../... - 2302340



Shielded round cable, assembled with one D-SUB male and one female connector, variable cable length

---

Cable - CABLE D-SUB-B-B-S/.../.../... - 2302421



Shielded round cable, assembled with two D-SUB female connectors, variable cable length

---

---

Phoenix Contact 2020 © - all rights reserved  
<http://www.phoenixcontact.com>

PHOENIX CONTACT GmbH & Co. KG  
Flachmarktstr. 8  
32825 Blomberg  
Germany  
Tel. +49 5235 300  
Fax +49 5235 3 41200  
<http://www.phoenixcontact.com>



## X-ON Electronics

Largest Supplier of Electrical and Electronic Components

*Click to view similar products for [Terminal Block Interface Modules](#) category:*

*Click to view products by [Phoenix Contact](#) manufacturer:*

Other Similar products are found below :

[73-551-6002I](#) [GCN1MX25B](#) [DIN-50P-01](#) [DIN-68H-01](#) [DIN-96DI-01](#) [2291901](#) [2295185](#) [2907794](#) [2M10FCL](#) [FLKM-2I/O](#) [FLKM-4I/O](#)  
[2281759](#) [2906251](#) [2907808](#) [5601749](#) [5541962](#) [1776613-1](#) [GCN1-004A](#) [ADAM-3920R-AE](#) [060-6827-06](#) [2311030](#) [2287708](#) [XW2C-20G6-](#)  
[IO16](#) [GCN1-T](#) [MACX](#) [MCR-VAC](#) [5775235](#) [ADAM-3956-BE](#) [XW6T-COM2.5X20YL](#) [XW6T-COM1.5X8BL](#) [XW6T-COM1.5X16BL](#)  
[XW6T-COM1.5X20YL](#) [XW6T-COM1.5X16YL](#) [XW6T-COM1.5X20RD](#) [XW6T-COM1.5X20BL](#) [XW6T-COM2.5X8BL](#) [1976610000](#) [UM](#)  
[45-D50SUB/B/ZFKDS](#) [5541234](#) [410-261](#) [902056](#) [2906243](#) [2906915](#) [2907706](#) [ADAM-3909-AE](#) [ADAM-3920-AE](#) [ADAM-3925-AE](#)  
[ADAM-3937-BE](#) [ADAM-3950-AE](#) [ADAM-3951-BE](#) [ADAM-3968-AE](#)