

Front adapters - VIP-PA-FLK14/ 4,0M/S7 - 2322715

Please be informed that the data shown in this PDF Document is generated from our Online Catalog. Please find the complete data in the user's documentation. Our General Terms of Use for Downloads are valid (<http://phoenixcontact.com/download>)



VIP VARIOFACE front adapter, with connected system cables for SMATIC S7-300, 2 x 8 channels can be connected, cable length: 4 m

Your advantages

- Power supply via terminal blocks with spring-cage double connection
- Can be screwed on with the I/O module
- Encapsulated socket strips on the module side

RoHS

Key Commercial Data

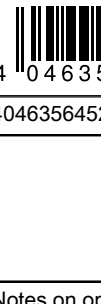
Packing unit	1 pc
GTIN	 4 046356 452458
GTIN	4046356452458

Technical data

Note

Type of note	Notes on operation
Note	Analog I/O cards To avoid short-circuits, all wire bridges must be disconnected! No voltage supply may be supplied to the front adapter!
Type of note	Notes on operation
Note	Digital I/O cards Thanks to the existing wire bridge upon delivery, the input and output bytes are non-isolated.

Ambient conditions

Ambient temperature (operation)	-20 °C ... 50 °C
Ambient temperature (storage/transport)	-20 °C ... 70 °C
Maximum altitude	≤ 2000 m
Degree of protection	IP20
	≥ IP54 (Installation location)

Front adapters - VIP-PA-FLK14/ 4,0M/S7 - 2322715

Technical data

General

Max. permissible operating voltage	25 V AC
	60 V DC
Max. permissible current	1 A (per path)
	8 A (per connection, supply via separate power supply)
Max. permissible total current	2 A (per byte, supply via separate bridged power supply)
Mounting position	any
Nominal operating mode	100% operating factor

Standards and Regulations

Connection in acc. with standard	CUL
Designation	Air clearances and creepage distances
Standards/regulations	DIN EN 50178
Rated insulation voltage	63 V
Rated surge voltage	0.6 kV
Insulation	Functional insulation
Pollution degree	2
Overvoltage category	II

Connection data

Connection name	Control side
Connection method	Plug connection
Note	Can be plugged onto 20-pos. I/O modules

Connection data 2

Connection name	Field level
Connection in acc. with standard	IEC 60603-13
Connection method	IDC/FLK socket strip
Number of connections	2
Number of positions	14
Pitch	2.54 mm

Connection data 3

Connection name	Supply
Connection method	Push-in connection
Stripping length	10 mm
Conductor cross section solid	0.2 mm ² ... 2.5 mm ²
Conductor cross section flexible	0.2 mm ² ... 2.5 mm ²
Conductor cross section AWG	24 ... 14

Cable

Conductor construction: Number of litz wires:	7
Single wire, material	Cu tin-plated
Single wire, cross section	0.14 mm ²

Front adapters - VIP-PA-FLK14/ 4,0M/S7 - 2322715

Technical data

Cable

External diameter	6.4 mm
Length of cable	4 m
Shielding	no
Halogen-free cable	No
Max. conductor resistance	0.16 Ω/m

Supported controller

Controller	SIEMENS S7-300 / ET 200 M
- suitable I/O card	6ES7 321-1BH50-0AA0
	6ES7 321-7BH01-0AB0
	6ES7 321-1BH02-0AA0
	6ES7 321-1BH10-0AA0
	6ES7 322-1BH01-0AA0
	6ES7 322-8BF00-0AB0
	6ES7 322-1BH10-0AA0
	6ES7 323-1BH01-0AA0
	6ES7 331-7HF01-0AB0
	6ES7 331-7KF02-0AB0
	6ES7 331-7KB02-0AB0
	6ES7 331-7TF01-0AB0
	6ES7 332-5HD01-0AB0
	6ES7 332-5HB01-0AB0
	6ES7 332-7ND02-0AB0
	6ES7 332-8TF01-0AB0
	6ES7 334-0CE01-0AA0
	6ES7 334-0KE00-0AB0
	6ES7 335-7HG01-0AB0
	6ES7 338-4BC01-0AB0
	6ES7 350-1AH03-0AE0
	6ES7 351-1AH01-0AE0
	6ES7 352-1AH02-0AE0
	6ES7 353-1AH01-0AE0
	6ES7 354-1AH01-0AE0
	6ES7 355-0VH10-0AE0
	6ES7 355-1VH10-0AE0

Environmental Product Compliance

China RoHS	Environmentally Friendly Use Period = 50 years
	For details about hazardous substances go to tab "Downloads", Category "Manufacturer's declaration"

Drawings

Front adapters - VIP-PA-FLK14/ 4,0M/S7 - 2322715

Circuit diagram

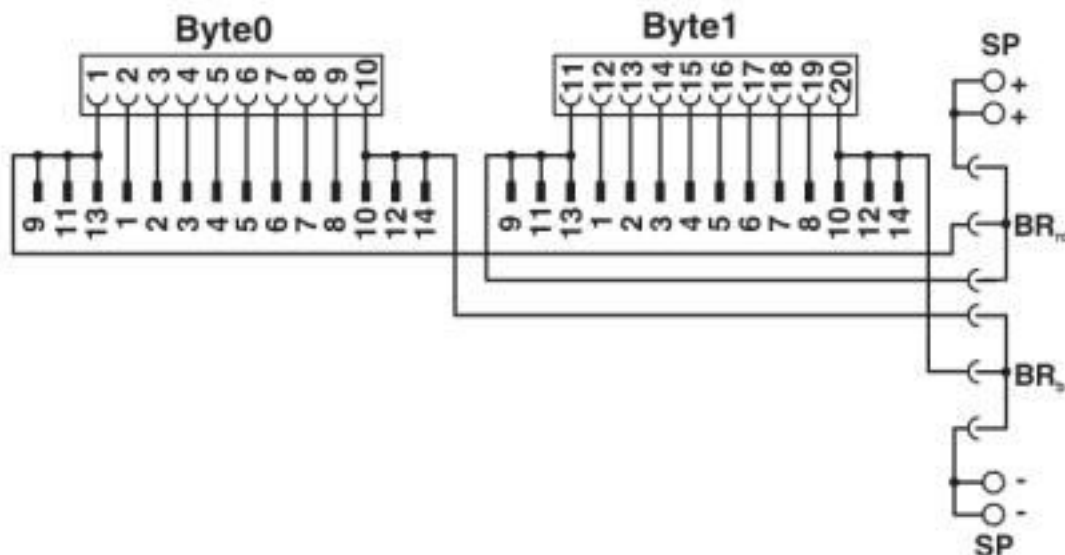

Classifications

eCl@ss

eCl@ss 10.0.1	27242292
eCl@ss 4.0	27060300
eCl@ss 4.1	27060300
eCl@ss 5.0	27061800
eCl@ss 5.1	27061800
eCl@ss 6.0	27249200
eCl@ss 7.0	27249290
eCl@ss 8.0	27249290
eCl@ss 9.0	27242292

ETIM

ETIM 4.0	EC002584
ETIM 5.0	EC002584
ETIM 6.0	EC002584
ETIM 7.0	EC002584

UNSPSC

UNSPSC 6.01	26121620
UNSPSC 7.0901	26121620
UNSPSC 11	26121620
UNSPSC 12.01	26121620
UNSPSC 13.2	32151601
UNSPSC 18.0	32151601
UNSPSC 19.0	32151601

Front adapters - VIP-PA-FLK14/ 4,0M/S7 - 2322715

Classifications

UNSPSC

UNSPSC 20.0	32151601
UNSPSC 21.0	32151601

Approvals

Approvals

Approvals

UL Recognized / cUL Recognized / EAC / cULus Recognized

Ex Approvals

Approval details

UL Recognized		http://database.ul.com/cgi-bin/XYV/template/LISEXT/1FRAME/index.htm	FILE E 238705
Nominal voltage UN		50 V	
Nominal current IN		1 A	

cUL Recognized		http://database.ul.com/cgi-bin/XYV/template/LISEXT/1FRAME/index.htm	FILE E 238705
Nominal voltage UN		50 V	
Nominal current IN		1 A	

EAC		RU C- DE.A*30.B00767
-----	---	-------------------------

cULus Recognized	
------------------	---

Accessories

Accessories

Controller board

Front adapters - VIP-PA-FLK14/ 4,0M/S7 - 2322715

Accessories

Passive module - VIP-2/SC/2FLK14 (1-20) /S7 - 2315230



VARIOFACE interface module for Siemens SIMATIC® S7-300, for max. 16 channels with SIMATIC®-specific labeling (1 - 20), with screw connection, module width: 80.6 mm

Passive module - VIP-2/PT/2FLK14 (1-20) /S7 - 2903802



VARIOFACE interface module for Siemens SIMATIC® S7-300, for max. 16 channels with SIMATIC®-specific labeling (1 - 20), with push-in connection, module width: 82.5 mm

Passive module - FLKM-2FLK14/KDS3-MT/PPA/S7 - 2295062



VARIOFACE interface module for Siemens SIMATIC® S7-300, for max. 16 channels, with SIMATIC®-specific labeling (1 - 20), knife disconnect terminal block and test connection, module width: 113 mm

System connection - PLC-V8/FLK14/OUT - 2295554



V8 adapter for 8 x PLC-INTERFACE (6.2 mm), controller: PLC system cabling of output cards, connection 1: Screw connection 1x, connection 2: IDC/FLK pin strip 1x 14-position, connection 3: Plug connection (Can be snapped onto 8x PLC-INTERFACE terminals), number of channels: 8, control logic: positive switching

System connection - PLC-V8/FLK14/IN - 2296553



V8 adapter for 8 x PLC-INTERFACE (6.2 mm), controller: PLC system cabling of input cards, connection 1: Screw connection 1x, connection 2: IDC/FLK pin strip 1x 14-position, connection 3: Plug connection (Can be snapped onto 8x PLC-INTERFACE terminals), number of channels: 8, control logic: positive switching

Front adapters - VIP-PA-FLK14/ 4,0M/S7 - 2322715

Accessories

System connection - PLC-V8L/FLK14/OUT - 2299660



V8 adapter for 8 x PLC-INTERFACE (14 mm), controller: PLC system cabling of output cards, connection 1: Screw connection 1x, connection 2: IDC/FLK pin strip 1x 14-position, connection 3: Plug connection (Can be snapped onto 8x PLC-INTERFACE terminals), number of channels: 8, control logic: positive switching

Passive module - VIP-3/SC/FLK14/8IM/PLC - 2322278



VARIOFACE sensor module, for connecting 8 pnp sensors

Passive module - VIP-3/PT/FLK14/8IM/PLC - 2904282



VARIOFACE sensor module, with push-in connection, for connecting 8 pnp sensors

Marker carrier cable

Cable marker carrier - KME - 0807083



Cable marker carrier, white, unlabeled, mounting type: Assembly with cable binders, cable diameter: > 5 mm, lettering field size: 20 mm x 8 mm

Phoenix Contact 2020 © - all rights reserved
<http://www.phoenixcontact.com>

PHOENIX CONTACT GmbH & Co. KG
Flachsmarktstr. 8
32825 Blomberg
Germany
Tel. +49 5235 300
Fax +49 5235 3 41200
<http://www.phoenixcontact.com>

X-ON Electronics

Largest Supplier of Electrical and Electronic Components

Click to view similar products for [Terminal Block Tools & Accessories](#) category:

Click to view products by [Phoenix Contact](#) manufacturer:

Other Similar products are found below :

[00171430102](#) [00171420102](#) [600HL](#) [600RJ-07](#) [600RJ-11](#) [600RJ-14](#) [600RJS-10](#) [600RJS-12](#) [600RJS-15](#) [600RJS-21](#) [601RJ-09](#) [602SP](#) [602Z](#)
[604J](#) [CSTSPC1-2](#) [7B941-7](#) [88943-2100](#) [QC102](#) [1437403-6](#) [1437403-9](#) [1437403-8](#) [1453128-1](#) [147832-1](#) [EC0037-000](#) [MT2/H--](#) [MT6/H-N](#)
[MT6/V-GRND](#) [MT8/H-51-60](#) [BC2-12](#) [BCC-1-8/10](#) [EP2.5/4UN/BG](#) [1707755](#) [1735590](#) [1755480](#) [1789281](#) [1840227](#) [1840230](#) [2-1437402-1](#)
[JA2-03](#) [JB1-03/J](#) [JB2-04](#) [JB2-05](#) [JB2-07](#) [JB2-09/J](#) [PARALLELJUMPERLINK](#) [JS601](#) [2204082](#) [2302463](#) [2305949](#) [8PCV-BUSHING](#)