

## I/O module - AXL F DO16/3 2F - 2688048

Please be informed that the data shown in this PDF Document is generated from our Online Catalog. Please find the complete data in the user's documentation. Our General Terms of Use for Downloads are valid (<http://phoenixcontact.com/download>)



Axioline F, Digital output module, Digital outputs: 16, 24 V DC, 500 mA, connection method: 3-wire, transmission speed in the local bus: 100 Mbps, degree of protection: IP20, including bus base module and Axioline F connectors

### Product Description

The module is designed for use within an Axioline F station. It is used to output digital signals. The outputs are protected against short circuit and overload.

### Your advantages

- ✓ 16 digital outputs
- ✓ 24 V DC, 500 mA
- ✓ Connection of actuators in 2 and 3-wire technology
- ✓ Minimum update time of < 100 µs
- ✓ Device rating plate stored



### Key Commercial Data

Packing unit	1 pc
GTIN	 4 046356 501583
GTIN	4046356501583

### Technical data

#### Dimensions

Width	53.6 mm
Height	129.9 mm
Depth	54 mm
Note on dimensions	The depth is valid when a TH 35-7,5 DIN rail is used (according to EN 60715).

#### Ambient conditions

Ambient temperature (operation)	-25 °C ... 60 °C
Ambient temperature (storage/transport)	-40 °C ... 85 °C

# I/O module - AXL F DO16/3 2F - 2688048

## Technical data

### Ambient conditions

Permissible humidity (operation)	5 % ... 95 % (non-condensing)
Permissible humidity (storage/transport)	5 % ... 95 % (non-condensing)
Air pressure (operation)	70 kPa ... 106 kPa (up to 3000 m above sea level)
Air pressure (storage/transport)	70 kPa ... 106 kPa (up to 3000 m above sea level)
Degree of protection	IP20

### Connection data

Designation	Axioline F connector
Connection method	Push-in connection
Note on the connection method	Please observe the information provided on conductor cross sections in the "Axioline F: system and installation" user manual.
	Applications with UL approval: only use copper conductors.
Conductor cross section solid min.	0.2 mm <sup>2</sup>
Conductor cross section solid max.	1.5 mm <sup>2</sup>
Conductor cross section flexible min.	0.2 mm <sup>2</sup>
Conductor cross section flexible max.	1.5 mm <sup>2</sup>
Conductor cross section AWG min.	24
Conductor cross section AWG max.	16
Stripping length	8 mm

### General

Mounting type	DIN rail
Color	traffic grey A RAL 7042
Net weight	234 g
Note on weight specifications	with connectors and bus base module
Mounting position	any (no temperature derating)

### Interfaces

Designation	Axioline F local bus
No. of channels	2
Connection method	Bus base module
Transmission speed	100 Mbps

### Axioline potentials

Designation	Axioline F local bus supply (U <sub>Bus</sub> )
Supply voltage	5 V DC (via bus base module)
Current consumption	max. 120 mA (up to HW 04)
	max. 60 mA (as of HW 05)
Power consumption	max. 600 mW (up to HW 04)
	max. 300 mW (as of HW 05)
Designation	Supply for digital output modules (U <sub>O</sub> )
Supply voltage	24 V DC
Supply voltage range	19.2 V DC ... 30 V DC (including all tolerances, including ripple)

# I/O module - AXL F DO16/3 2F - 2688048

## Technical data

### Axioline potentials

Current consumption	max. 8 A (provide external protection)
Power consumption	max. 240 W (of which 560 mW with internal losses)
Protective circuit	Surge protection electronic (35 V, 0.5 s)
	Reverse polarity protection parallel diode; with external 5 A fuse (only for commissioning)
Protection	max. 8 A (polarity reversal protection up to 5 A)

### Digital outputs

Output name	Digital outputs
Connection method	Push-in connection
Connection technology	3-wire
Number of outputs	16
Protective circuit	Short-circuit protection, overload protection of the outputs electronic
Output voltage	24 V
Nominal output voltage	24 V DC
Maximum output current per channel	500 mA
Maximum output current per module	8 A (provide external protection)
Nominal load, inductive	max. 12 VA (1.2 H, 48 Ω, with nominal voltage)
Nominal load, lamp	max. 12 W (at nominal voltage)
Nominal load, ohmic	max. 12 W (48 Ω, with nominal voltage)
Switching frequency	max. 10000 per second (with at least 50 mA load current)
Load min.	10 kΩ
Output voltage when switched off	max. 1 V
Output current when switched off	max. 300 μA
Behavior with overload	Shutdown with automatic restart
Behavior with inductive overload	Output can be destroyed
Reverse voltage resistance to short pulses	limited protection up to 0.5 A for 1 s

### Electrical isolation

Test section	5 V supply of the local bus ( $U_{BUS}$ ) / 24 V supply (I/Os) 500 V AC 50 Hz 1 min.
	5 V supply of the local bus ( $U_{BUS}$ ) / functional ground 500 V AC 50 Hz 1 min.
	24 V supply (I/O)/functional ground 500 V AC 50 Hz 1 min.

### Standards and Regulations

Mechanical tests	Vibration resistance in acc. with EN 60068-2-6/IEC 60068-2-6 5g
	Shock in acc. with EN 60068-2-27/IEC 60068-2-27 30g
	Continuous shock according to EN 60068-2-27/IEC 60068-2-27 10g
Protection class	III (IEC 61140, EN 61140, VDE 0140-1)

### Environmental Product Compliance

REACH SVHC	Lead 7439-92-1
China RoHS	Environmentally Friendly Use Period = 50 years

# I/O module - AXL F DO16/3 2F - 2688048

## Technical data

## Environmental Product Compliance

For details about hazardous substances go to tab "Downloads", Category "Manufacturer's declaration"

## Drawings

Block diagram

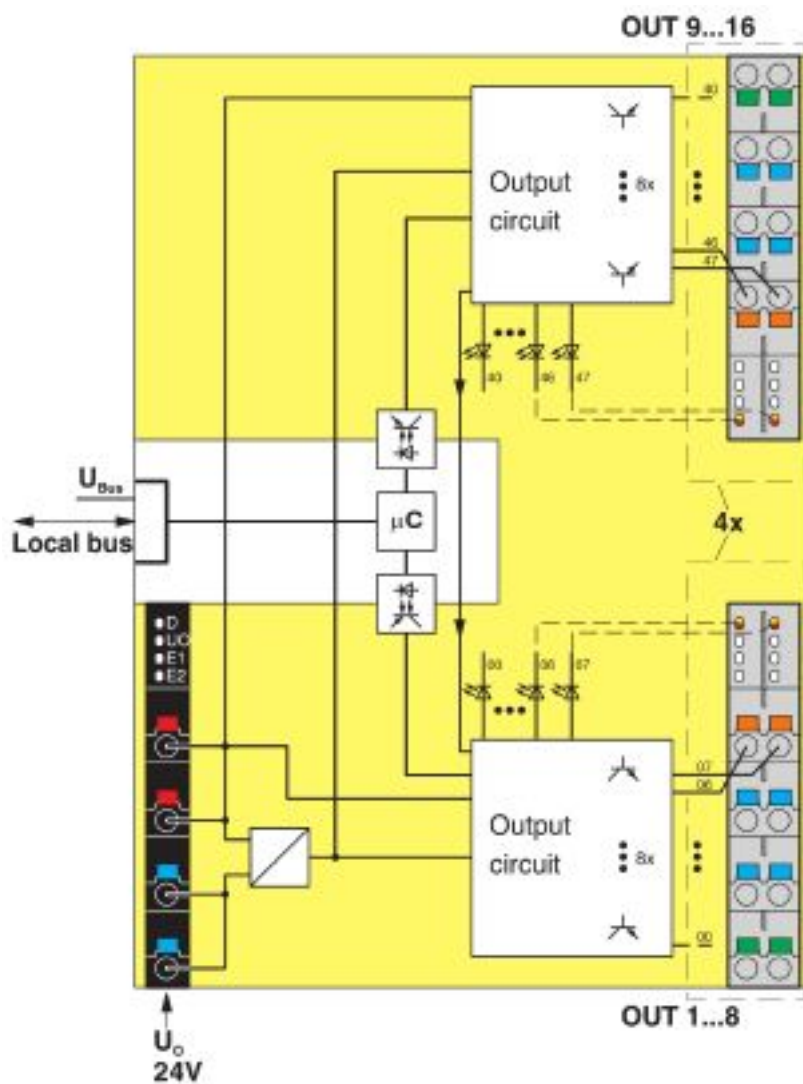

Internal wiring of the terminal points

# I/O module - AXL F DO16/3 2F - 2688048

Connection diagram

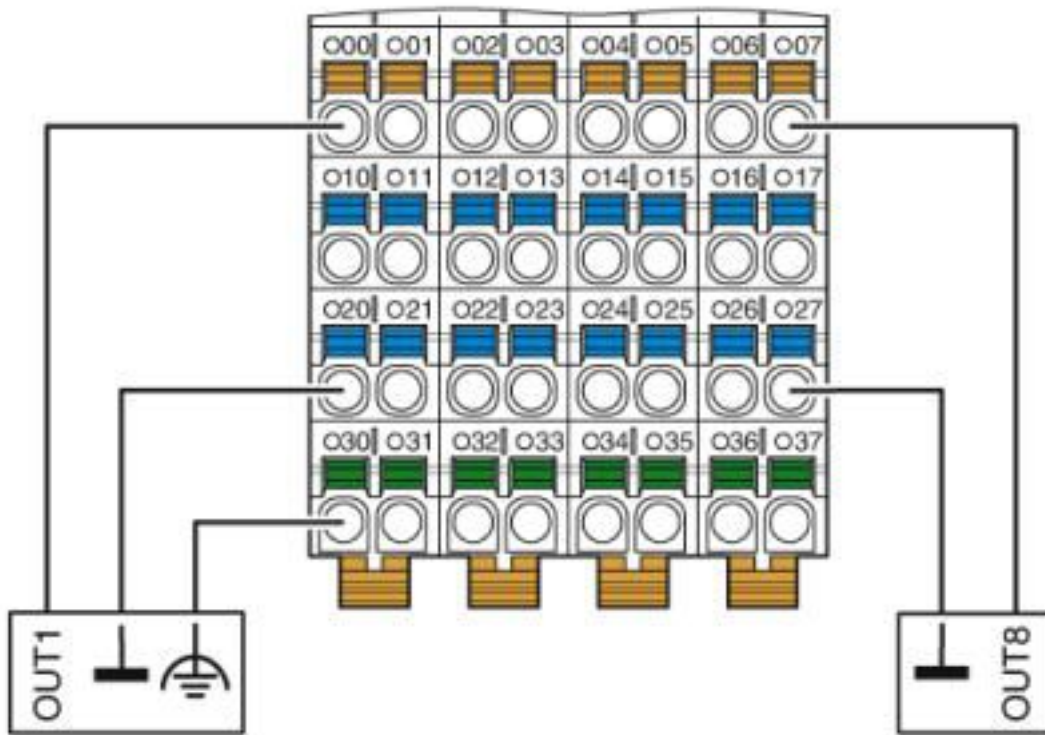

Connection example

Diagram

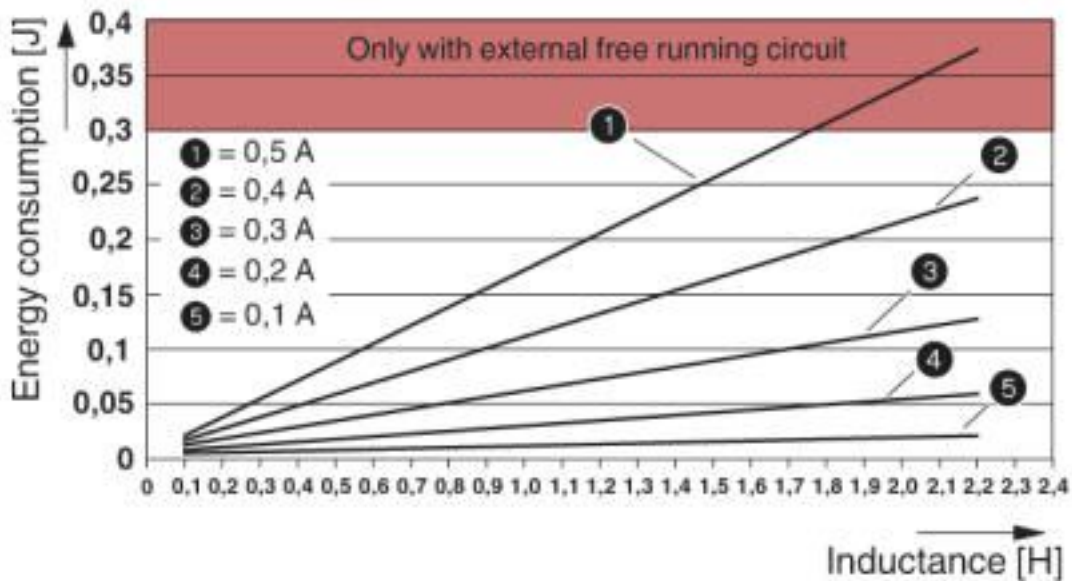

Maximum energy consumption of the outputs when switching off inductive loads

The diagram shows the maximum amount of energy that may be fed back into the corresponding output groups (outputs 1 to 4, 5 to 8, 9 to 12, 13 to 16) for each switch off procedure when switching off an inductive load without external freewheeling circuit.

## I/O module - AXL F DO16/3 2F - 2688048

The current data refers to the ohmic DC voltage component of the inductive load.

Note: Restrict freewheeling voltage to a maximum of -15 V when using an external freewheeling circuit. The external freewheeling circuit has no function in the event of a higher negative voltage.

Dimensional drawing

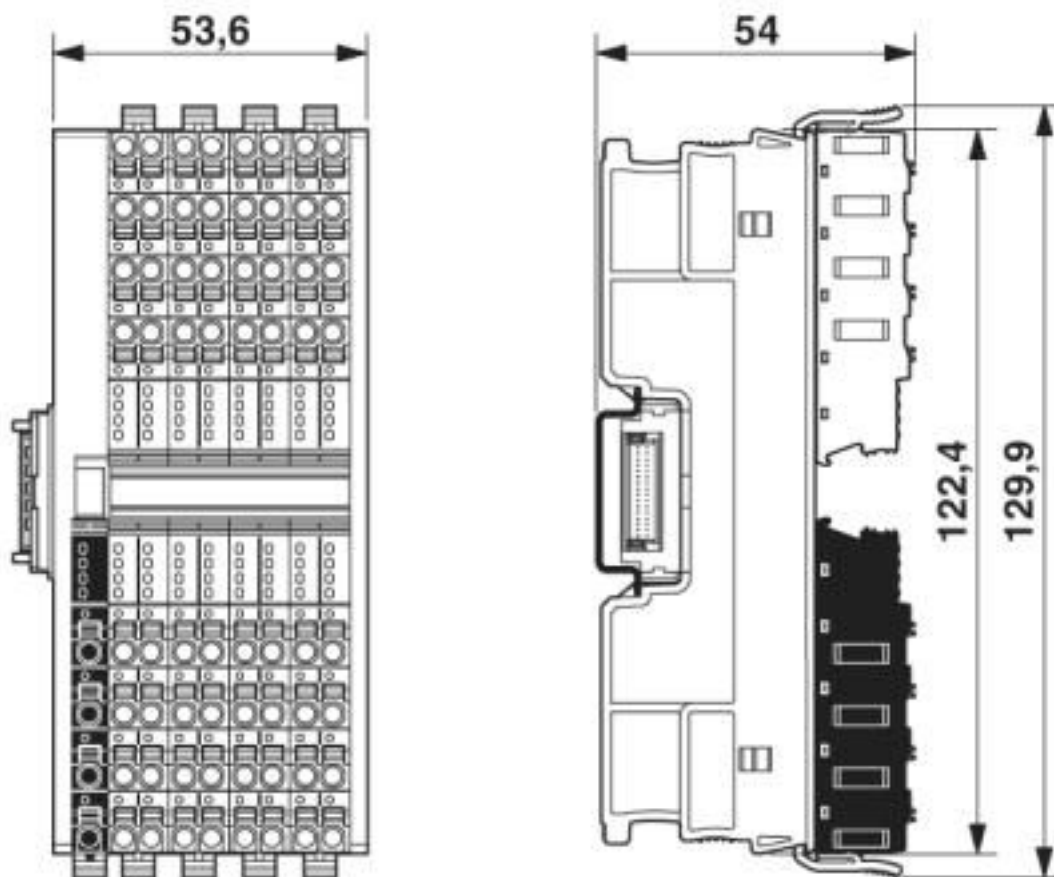

### Classifications

#### eCl@ss

eCl@ss 10.0.1	27242604
eCl@ss 4.0	27240400
eCl@ss 4.1	27240400
eCl@ss 5.0	27242200
eCl@ss 5.1	27242600
eCl@ss 6.0	27242600
eCl@ss 7.0	27242604
eCl@ss 8.0	27242604
eCl@ss 9.0	27242604

#### ETIM

ETIM 3.0	EC001599
ETIM 4.0	EC001599

# I/O module - AXL F DO16/3 2F - 2688048

## Classifications

### ETIM

ETIM 5.0	EC001599
ETIM 6.0	EC001599
ETIM 7.0	EC001599

### UNSPSC

UNSPSC 6.01	43172015
UNSPSC 7.0901	43201404
UNSPSC 11	39121311
UNSPSC 12.01	39121311
UNSPSC 13.2	32151602
UNSPSC 18.0	32151602
UNSPSC 19.0	32151602
UNSPSC 20.0	32151602
UNSPSC 21.0	32151602

## Approvals



### Approvals

#### Approvals

PRS / BV / LR / KR / NK / ABS / RINA / LR / NK / ABS / PRS / BV / RINA / KR / BSH / EAC / EAC / DNV GL / UL Listed / cUL Listed / UL Listed / cUL Listed / DNV GL







#### Ex Approvals

### Approval details

PRS		<a href="http://www.prs.pl/">http://www.prs.pl/</a>	TE/2239/880590/19
BV		<a href="http://www.veristar.com/portal/veristarinfo/generalinfo/approved/approvedProducts/equipmentAndMaterials">http://www.veristar.com/portal/veristarinfo/generalinfo/approved/approvedProducts/equipmentAndMaterials</a>	36433/B1 BV
LR		<a href="http://www.lr.org/en">http://www.lr.org/en</a>	LR2001902TA

# I/O module - AXL F DO16/3 2F - 2688048

## Approvals

KR		<a href="http://www.krs.co.kr/eng/main/main.aspx">http://www.krs.co.kr/eng/main/main.aspx</a>	HMB17372-AC002
NK	<b>ClassNK</b>	<a href="http://www.classnk.or.jp/hp/en/">http://www.classnk.or.jp/hp/en/</a>	14A006
ABS		<a href="http://www.eagle.org/eagleExternalPortalWEB/">http://www.eagle.org/eagleExternalPortalWEB/</a>	18-HG1767360-PDA
RINA		<a href="http://www.rina.org/en">http://www.rina.org/en</a>	ELE030120XG
LR		<a href="http://www.lr.org/en">http://www.lr.org/en</a>	LR2001902TA
NK	<b>ClassNK</b>	<a href="http://www.classnk.or.jp/hp/en/">http://www.classnk.or.jp/hp/en/</a>	14A006
ABS		<a href="http://www.eagle.org/eagleExternalPortalWEB/">http://www.eagle.org/eagleExternalPortalWEB/</a>	18-HG1767360-PDA
PRS		<a href="http://www.prs.pl/">http://www.prs.pl/</a>	TE/2239/880590/19
BV		<a href="http://www.veristar.com/portal/veristarinfo/generalinfo/approved/approvedProducts/equipmentAndMaterials">http://www.veristar.com/portal/veristarinfo/generalinfo/approved/approvedProducts/equipmentAndMaterials</a>	36433/B1 BV
RINA		<a href="http://www.rina.org/en">http://www.rina.org/en</a>	ELE030120XG
KR		<a href="http://www.krs.co.kr/eng/main/main.aspx">http://www.krs.co.kr/eng/main/main.aspx</a>	HMB17372-AC002
BSH			840



# I/O module - AXL F DO16/3 2F - 2688048

## Approvals

EAC			EAC-Zulassung
EAC			EAC-Zulassung
DNV GL		<a href="https://approvalfinder.dnvgl.com/">https://approvalfinder.dnvgl.com/</a>	TAA00000DF
UL Listed		<a href="http://database.ul.com/cgi-bin/XYV/template/LISEXT/1FRAME/index.htm">http://database.ul.com/cgi-bin/XYV/template/LISEXT/1FRAME/index.htm</a>	FILE E 238705
cUL Listed		<a href="http://database.ul.com/cgi-bin/XYV/template/LISEXT/1FRAME/index.htm">http://database.ul.com/cgi-bin/XYV/template/LISEXT/1FRAME/index.htm</a>	FILE E 238705
UL Listed		<a href="http://database.ul.com/cgi-bin/XYV/template/LISEXT/1FRAME/index.htm">http://database.ul.com/cgi-bin/XYV/template/LISEXT/1FRAME/index.htm</a>	FILE E 238705
cUL Listed		<a href="http://database.ul.com/cgi-bin/XYV/template/LISEXT/1FRAME/index.htm">http://database.ul.com/cgi-bin/XYV/template/LISEXT/1FRAME/index.htm</a>	FILE E 238705
DNV GL		<a href="https://approvalfinder.dnvgl.com/">https://approvalfinder.dnvgl.com/</a>	TAA00000DF

## Accessories

### Accessories

DIN rail connector

Bus connector - AXL F BS F - 2688129



Axioline F bus base module for housing type F

## I/O module - AXL F DO16/3 2F - 2688048

### Accessories

---

#### Terminal marking

Zack marker strip - ZB 20,3 AXL UNPRINTED - 0829579



Zack marker strip for AxioLine F (device labeling), in 2 x 20.3 mm pitch, unprinted, 25-section, for individual labeling with B-STIFT 0.8, X-PEN, or CMS-P1-PLOTTER

---

Zack Marker strip, flat - ZBF 10/5,8 AXL UNPRINTED - 0829580



Zack Marker strip, flat, Strip, white, unlabeled, can be labeled with: PLOTMARK, CMS-P1-PLOTTER, mounting type: snap into flat marker groove, for terminal block width: 10.15 mm, lettering field size: 4 of 10.15 x 5 mm and 1 of 5.8 x 5 mm, Number of individual labels: 50

---

Phoenix Contact 2020 © - all rights reserved  
<http://www.phoenixcontact.com>

PHOENIX CONTACT GmbH & Co. KG  
Flachsmarktstr. 8  
32825 Blomberg  
Germany  
Tel. +49 5235 300  
Fax +49 5235 3 41200  
<http://www.phoenixcontact.com>

## X-ON Electronics

Largest Supplier of Electrical and Electronic Components

*Click to view similar products for [Terminal Block Interface Modules](#) category:*

*Click to view products by [Phoenix Contact](#) manufacturer:*

Other Similar products are found below :

[73-551-6002I](#) [GCN1MX25B](#) [DIN-50P-01](#) [DIN-68H-01](#) [DIN-96DI-01](#) [2291901](#) [2295185](#) [2907794](#) [2M10FCL](#) [FLKM-2I/O](#) [FLKM-4I/O](#)  
[2281759](#) [2906251](#) [2907808](#) [5601749](#) [5541962](#) [1776613-1](#) [GCN1-004A](#) [ADAM-3920R-AE](#) [060-6827-06](#) [2311030](#) [2287708](#) [XW2C-20G6-](#)  
[IO16](#) [GCN1-T](#) [MACX](#) [MCR-VAC](#) [5775235](#) [ADAM-3956-BE](#) [XW6T-COM2.5X20YL](#) [XW6T-COM1.5X8BL](#) [XW6T-COM1.5X16BL](#)  
[XW6T-COM1.5X20YL](#) [XW6T-COM1.5X16YL](#) [XW6T-COM1.5X20RD](#) [XW6T-COM1.5X20BL](#) [XW6T-COM2.5X8BL](#) [1976610000](#) [UM](#)  
[45-D50SUB/B/ZFKDS](#) [5541234](#) [410-261](#) [902056](#) [2906243](#) [2906915](#) [2907706](#) [ADAM-3909-AE](#) [ADAM-3920-AE](#) [ADAM-3925-AE](#)  
[ADAM-3937-BE](#) [ADAM-3950-AE](#) [ADAM-3951-BE](#) [ADAM-3968-AE](#)