

FO converters - PSI-MOS-PROFIB/FO 850 E - 2708274

Please be informed that the data shown in this PDF Document is generated from our Online Catalog. Please find the complete data in the user's documentation. Our General Terms of Use for Downloads are valid (<http://phoenixcontact.com/download>)



FO converter with integrated optical diagnostics, alarm contact, for PROFIBUS up to 12 Mbps, terminal device with one FO interface (BFOC), 850 nm, for PCF/fiberglass cable (multimode)

Product Description

The PSI-MOS-PROFIB/FO... devices convert copper-based PROFIBUS interfaces to fiber optics. The integrated optical diagnostics allow permanent monitoring of the FO paths during installation and also during operation. The floating switch contact is activated when the signal output on the fiber optic paths drops to a critical level. The PSI-MOS-PROFIB/FO... E terminal devices convert a PROFIBUS interface for a FO cable. They are ideal for point-to-point connections.

Your advantages

- ✓ Connections can be plugged in using a COMBICON screw terminal block
- ✓ Can be combined with the PSI copper repeater in a modular way using DIN rail connectors
- ✓ Supply voltage and data signals routed through via DIN rail connectors
- ✓ Automatic data rate detection or fixed data rate setting via DIP switches
- ✓ High-quality electrical isolation between all interfaces (PROFIBUS // fiber optic ports // power supply // DIN rail connector)
- ✓ Redundant power supply possible by means of optional system power supply unit
- ✓ Approved for use in zone 2
- ✓ Integrated optical diagnostics for continuous monitoring of fiber optic paths
- ✓ Intrinsically safe fiber optic interface (Ex op is) for direct connection to devices in zone 1
- ✓ Floating switch contact for leading alarm generation in relation to critical fiber optic paths
- ✓ Suitable for all data rates up to 12 Mbps
- ✓ Bit retiming for any cascading depth
- ✓ Shipbuilding approval in accordance with DNV GL



Key Commercial Data

Packing unit	1 pc
GTIN	 4 017918 973971
GTIN	4017918973971

Technical data

Note

FO converters - PSI-MOS-PROFIB/FO 850 E - 2708274

Technical data

Note

Utilization restriction	EMC: class A product, see manufacturer's declaration in the download area
-------------------------	---

Dimensions

Width	35 mm
Height	99 mm
Depth	106 mm

Ambient conditions

Ambient temperature (operation)	-20 °C ... 60 °C
Ambient temperature (storage/transport)	-40 °C ... 85 °C
Permissible humidity (operation)	30 % ... 95 % (non-condensing)
Altitude	≤ 5000 m (For restrictions, see the manufacturer's declaration for altitude operation)
Degree of protection	IP20
Noise immunity	EN 61000-6-2:2005

General

Bit delay	≤ 1 bit
Bit distortion, input	± 35 % (permitted)
Bit distortion, output	< 6.25 %
Electrical isolation	VCC // RS-485
Test voltage data interface/power supply	1.5 kV _{rms} (50 Hz, 1 min.)
Electromagnetic compatibility	Conformance with EMC Directive 2014/30/EU
Noise emission	EN 55011
Net weight	250 g
Housing material	PA 6.6-FR
Color	green
MTBF	252 Years (Telcordia standard, 25°C temperature, 21% operating cycle (5 days a week, 8 hours a day))
	42 Years (Telcordia standard, 40°C temperature, 34.25% operating cycle (5 days a week, 12 hours a day))
MTTF	247 Years (SN 29500 standard, temperature 25°C, operating cycle 21%)
	200 Years (SN 29500 standard, temperature 40°C, operating cycle 34.25%)
	130 Years (SN 29500 standard, temperature 40°C, operating cycle 100%)

Power supply

Nominal supply voltage	24 V DC (With UL approval)
Supply voltage range	18 V DC ... 30 V DC
Max. current consumption	130 mA
Typical current consumption	120 mA (24 V DC)
Connection method	COMBICON plug-in screw terminal block

Interfaces

FO converters - PSI-MOS-PROFIB/FO 850 E - 2708274

Technical data

Interfaces

Interface 1	PROFIBUS acc. to IEC 61158, RS-485 2-wire, half duplex, automatic control
Interface	PROFIBUS
Operating mode	Semi-duplex
Connection method	D-SUB-9 female connector
File format/coding	UART (11 Bit, NRZ)
Data direction switching	Automatic control
Transmission medium	Copper
Transmission length	≤ 1200 m (depending on the data rate, with shielded, twisted pair data cable)
Conductor cross section solid min.	0.2 mm ²
Conductor cross section solid max.	2.5 mm ²
Conductor cross section flexible min.	0.2 mm ²
Conductor cross section flexible max.	2.5 mm ²
Conductor cross section AWG min.	24
Conductor cross section AWG max.	14
Serial transmission speed	≤ 12 Mbps

Optical interface FO

No. of channels	1
Transmit capacity, minimum	-4.2 dBm (200/230 μm)
	-17.8 dBm (50/125 μm)
	-14.6 dBm (62,5/125 μm)
Minimum receiver sensitivity	-30 dBm (50/125 μm)
Overrange receiver	-3 dBm (200/230 μm)
Wavelength	850 nm
Transmission length incl. 3 dB system reserve	2600 m (with F-G 50/125 2.5 dB/km)
	3300 m (with F-G 62,5/125 3.0 dB/km)
	800 m (With F-K 200/230 10 dB/km with quick mounting connector)
Transmission medium	PCF fiber
	Multi-mode fiberglass
Transmission protocol	Protocol-transparent to the RS-485 interface
Connection method	B-FOC (ST®)

Digital outputs

Output name	Relay output
Output description	Alarm output
Number of outputs	1
Maximum switching voltage	60 V DC
	42 V AC
Limiting continuous current	0.46 A

Conformance/approvals

FO converters - PSI-MOS-PROFIB/FO 850 E - 2708274

Technical data

Conformance/approvals

Designation	CE
Identification	CE-compliant
Designation	EAC
Identification	EAC
Designation	ATEX
Identification	# II 3 G Ex nA nC IIC T4 Gc X
Additional text	Please follow the special installation instructions in the documentation!
Designation	ATEX, FO interface
Identification	# II (2) G [Ex op is Gb] IIC
	# II (2) D [Ex op is Db] IIIC
Certificate	PTB 06 ATEX 2042 U
Additional text	Please follow the special installation instructions in the documentation!
Designation	UL, USA/Canada
Identification	Class I, Zone 2, AEx nc IIC T5
	Class I, Zone 2, Ex nC nL IIC T5 X
	Class I, Div. 2, Groups A, B, C, D
Designation	PTB
	PROFIBUS approval
Additional text	PROFIBUS-Center Netherlands
Designation	Corrosive gas test
Identification	ISA-S71.04-1985 G3 Harsh Group A
Designation	Shipbuilding
Identification	DNV GL
Temperature	B
Humidity	A
Vibration	A
EMC	B
Enclosure	Required protection according to the Rules shall be provided upon installation on board

Standards and Regulations

Electromagnetic compatibility	Conformance with EMC Directive 2014/30/EU
Type of test	Vibration resistance in acc. with EN 60068-2-6/IEC 60068-2-6
Test result	5g, 10...150 Hz, 2.5 h, in XYZ direction
Type of test	Shock in acc. with EN 60068-2-27/IEC 60068-2-27
Test result	15g, 11 ms period, half-sine shock pulse
Noise emission	EN 55011
Noise immunity	EN 61000-6-2:2005
Free from substances that could impair the application of coating	according to P-VW 3.10.7 57 65 0 VW-AUDI-Seat central standard
Connection in acc. with standard	CUL
Standards/regulations	EN 61000-4-2

FO converters - PSI-MOS-PROFIB/FO 850 E - 2708274

Technical data

Standards and Regulations

Contact discharge	± 6 kV
Standards/regulations	EN 61000-4-3
	EN 61000-4-4
Comments	Criterion B
Standards/regulations	EN 61000-4-5
Signal	± 1 kV
Standards/regulations	EN 55011
	EN 61000-4-6

Environmental Product Compliance

REACH SVHC	Lead 7439-92-1
China RoHS	Environmentally Friendly Use Period = 50 years
	For details about hazardous substances go to tab "Downloads", Category "Manufacturer's declaration"

Drawings

FO converters - PSI-MOS-PROFIB/FO 850 E - 2708274

Application drawing

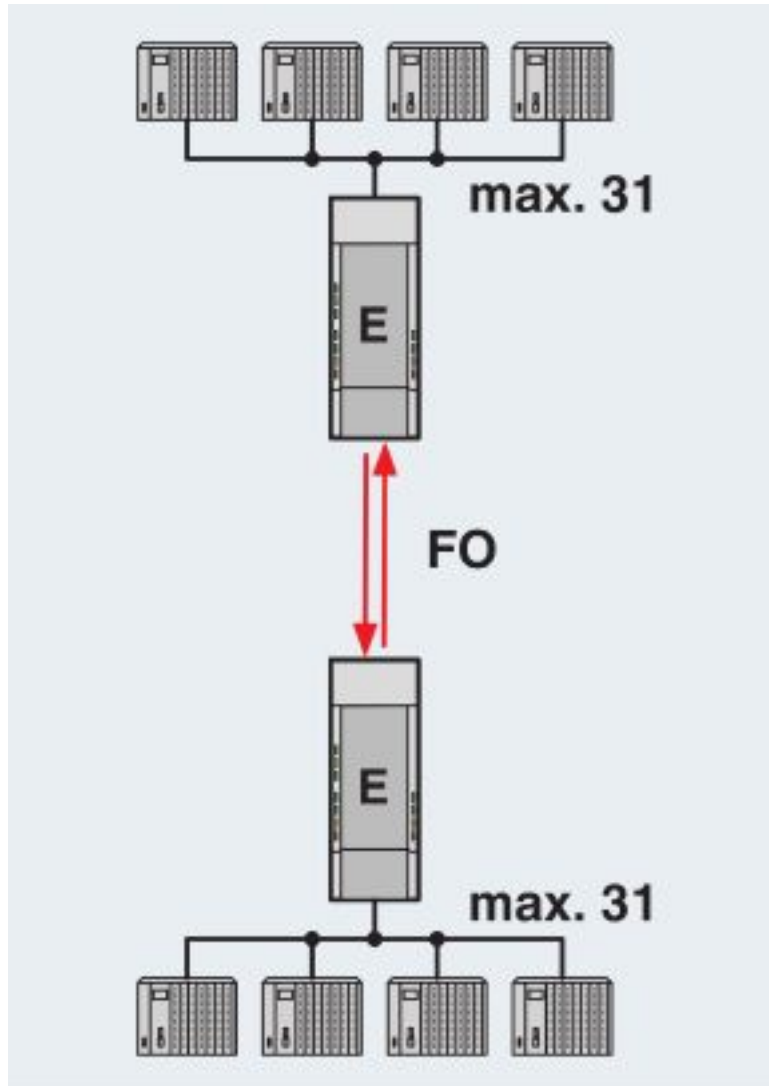

Point-to-point connection

FO converters - PSI-MOS-PROFIB/FO 850 E - 2708274

Application drawing

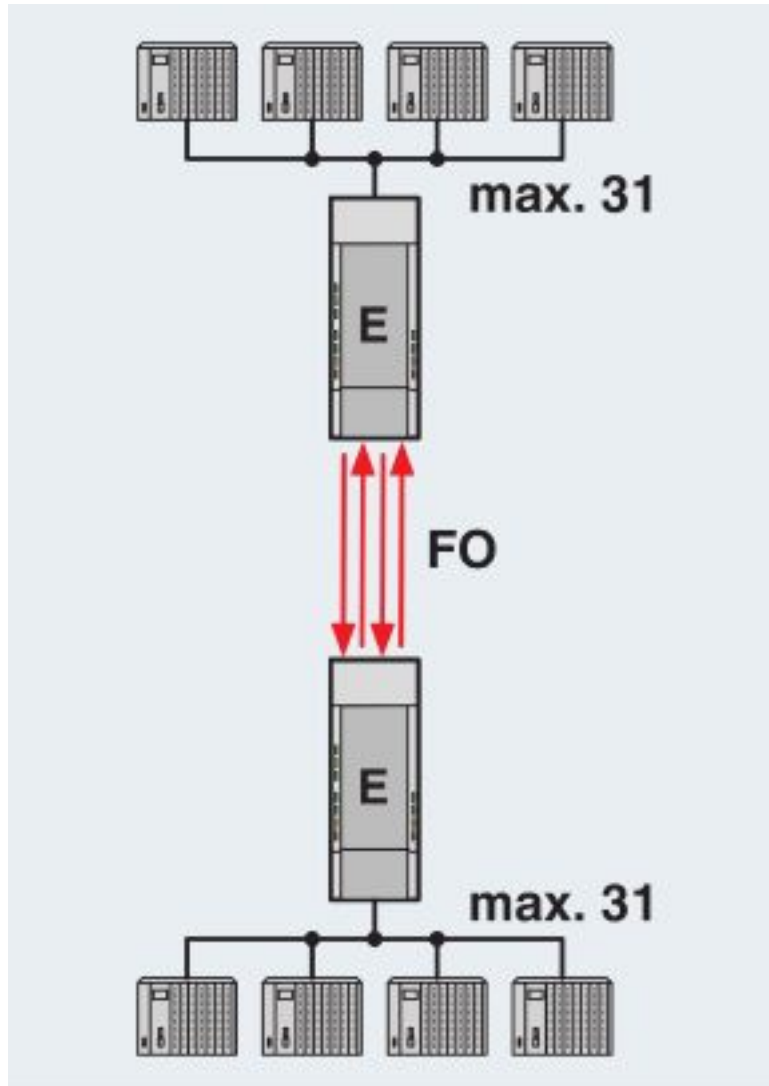

Redundant point-to-point connection

FO converters - PSI-MOS-PROFIB/FO 850 E - 2708274

Application drawing

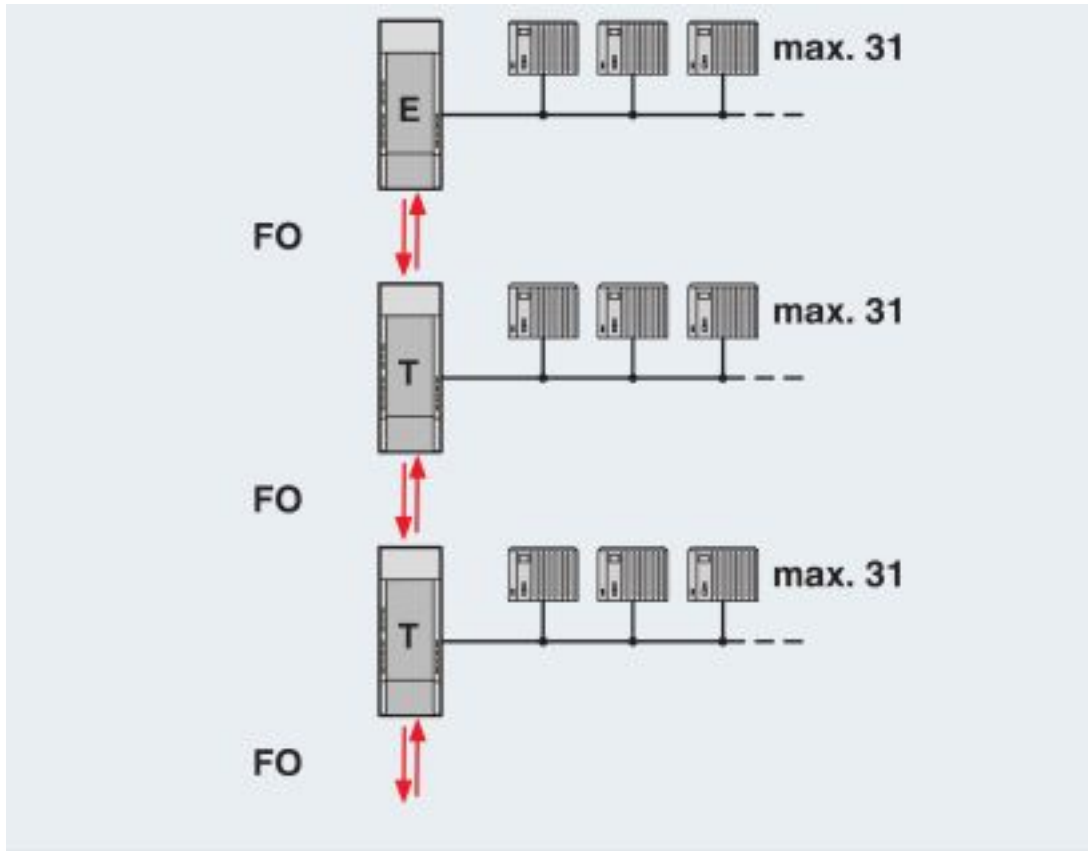

Line structure

FO converters - PSI-MOS-PROFIB/FO 850 E - 2708274

Application drawing

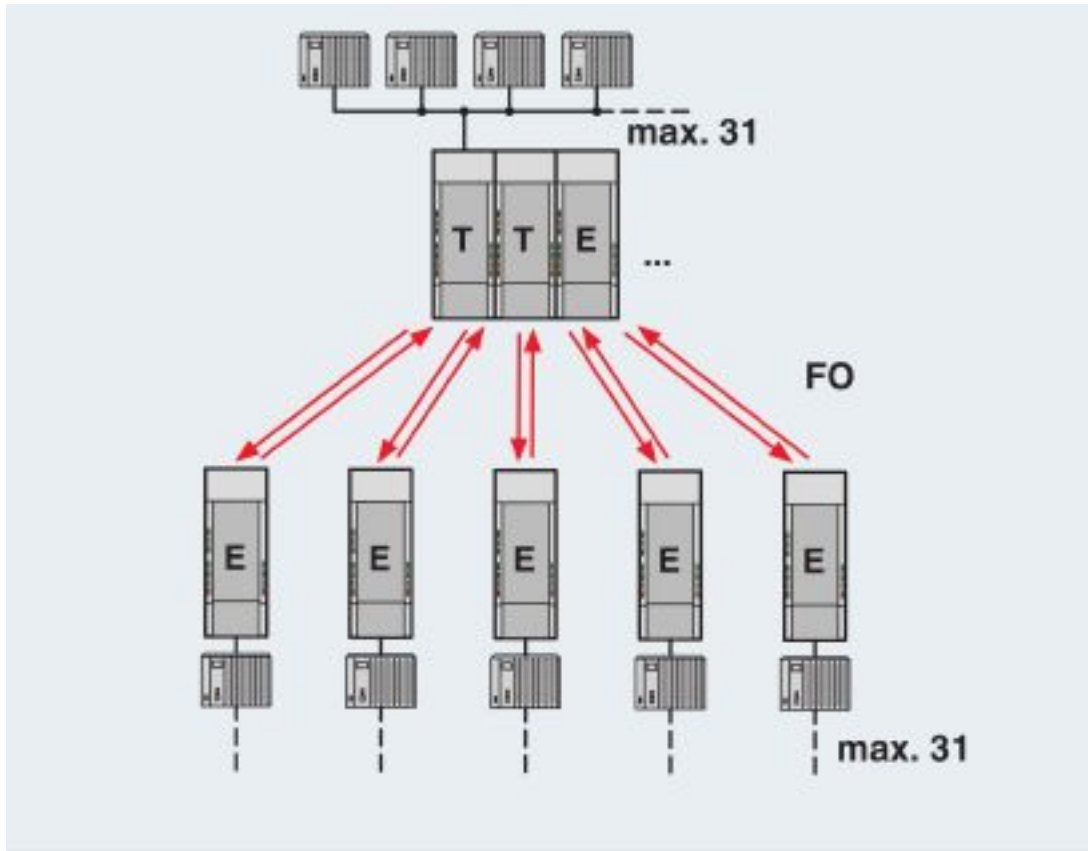

Star structure

FO converters - PSI-MOS-PROFIB/FO 850 E - 2708274

Application drawing

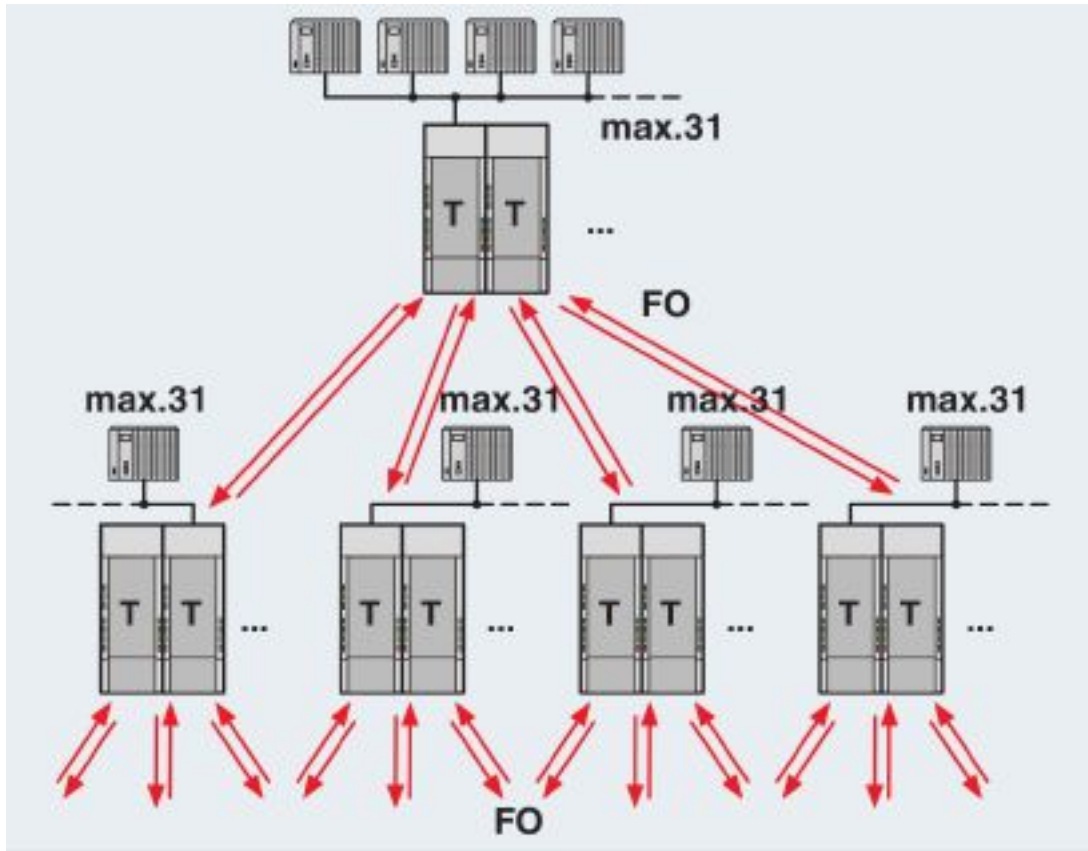

Tree structure

FO converters - PSI-MOS-PROFIB/FO 850 E - 2708274

Application drawing

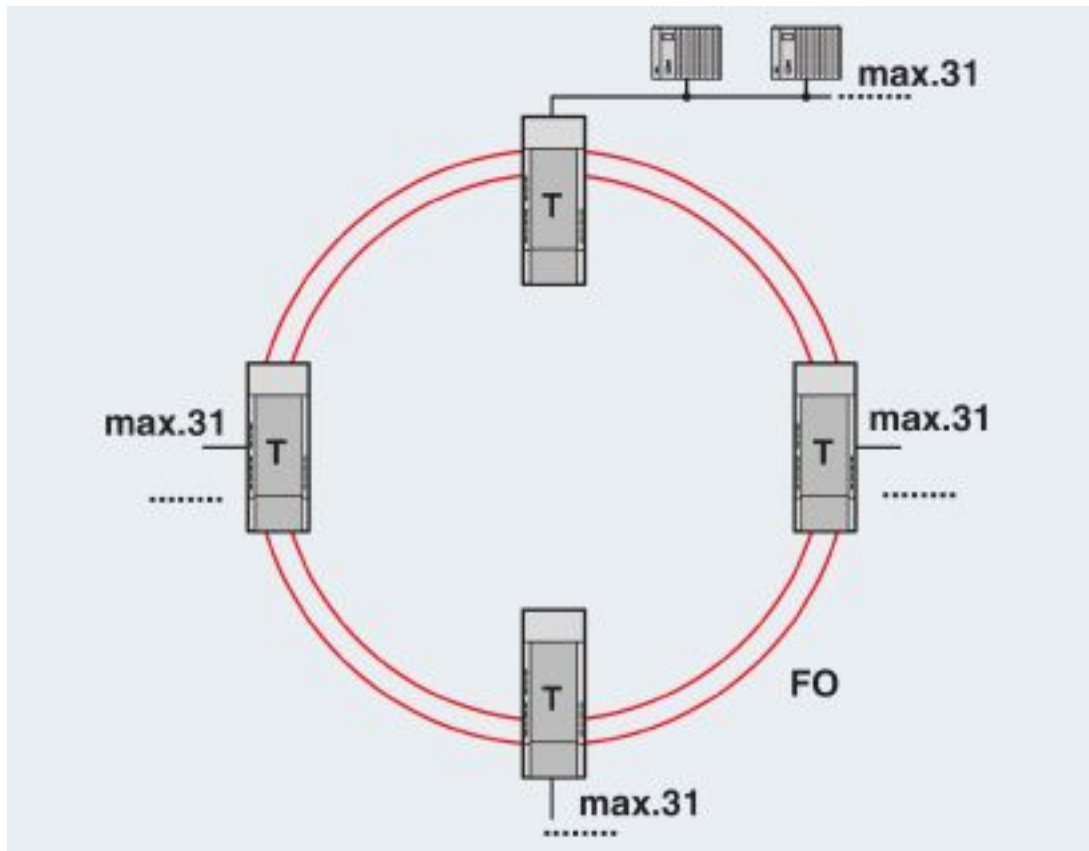

Redundant FO ring

Classifications

eCl@ss

eCl@ss 10.0.1	19170132
eCl@ss 4.0	27230200
eCl@ss 4.1	27230200
eCl@ss 5.0	27230200
eCl@ss 5.1	27230200
eCl@ss 6.0	19179200
eCl@ss 7.0	19179290
eCl@ss 8.0	19179290
eCl@ss 9.0	19170114

ETIM

ETIM 2.0	EC001423
ETIM 3.0	EC001423
ETIM 4.0	EC001423
ETIM 5.0	EC000310

FO converters - PSI-MOS-PROFIB/FO 850 E - 2708274

Classifications

ETIM

ETIM 6.0	EC001467
ETIM 7.0	EC001467

UNSPSC

UNSPSC 6.01	30211506
UNSPSC 7.0901	39121008
UNSPSC 11	39121008
UNSPSC 12.01	39121008
UNSPSC 13.2	43222604
UNSPSC 18.0	43223323
UNSPSC 19.0	43223323
UNSPSC 20.0	43223323
UNSPSC 21.0	43223323

Approvals

Approvals

Approvals

DNV GL / UL Recognized / cUL Recognized / EAC / EAC / cULus Recognized

Ex Approvals

UL Listed / cUL Listed / cULus Listed

Approval details

DNV GL		https://approvalfinder.dnvgl.com/	TAA00001KR
--------	--	---	------------

UL Recognized		http://database.ul.com/cgi-bin/XYV/template/LISEXT/1FRAME/index.htm	FILE E 238705
---------------	--	---	---------------

cUL Recognized		http://database.ul.com/cgi-bin/XYV/template/LISEXT/1FRAME/index.htm	FILE E 238705
----------------	--	---	---------------

EAC			EAC-Zulassung
-----	--	--	---------------

FO converters - PSI-MOS-PROFIB/FO 850 E - 2708274

Approvals

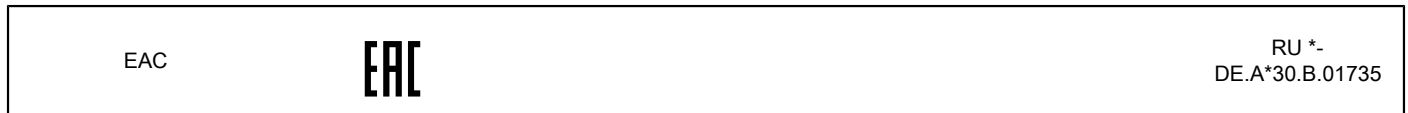

Accessories

Accessories

Adapter

Connection distributor - PSM PTK - 2760623



Passive RS-485 T-distributor, fitted with one 9-pin D-SUB pin strip and two 9-pin D-SUB socket strips

Connection distributor - PSM PTK-4 - 2799364



Passive RS-485 T-distributor, fitted with one 9-pin D-SUB pin strip and five 9-pin D-SUB socket strips

Data cable by the meter

FO cable - PSM-LWL-HCS-RUGGED-200/230 - 2799885



PCF cable, duplex 200 µm/230 µm, by the meter without male connector, for installation in stationary systems and machines

FO cable - PSM-LWL-HCSO-200/230 - 2799445



PCF cable, duplex 200/230 µm, by the meter, without connector, for outdoor installation

FO converters - PSI-MOS-PROFIB/FO 850 E - 2708274

Accessories

FO cable - PSM-LWL-GDM-RUGGED- 50/125 - 2799322



Fiber glass cable, duplex 50 µm/125 µm, by the meter, without male connector, for installation in stationary systems and machines

FO cable - PSM-LWL-GDO- 50/125 - 2799432



Fiberglass cable, duplex 50/125 µm, by the meter, without connector, for outdoor installation

Bus system cable - PSM-CABLE-PROFIB/FC - 2744652



By the meter, Bus system cable, PROFIBUS (12 Mbps), shielded, PVC FR VI/PVC, Violet, 2-wire (1X2XAWG22/1), color single wire: Red, green, cable length: Free entry (1.0 ... 1000.0 m)

Data cable preassembled

FO patch cable - FL MM PATCH 1,0 LC-ST - 2989174



Assembled FO cable, break out cable, multimode fiberglass 50/125 µm (OM2), connector: LC/B-FOC(ST®), degree of protection: IP20, for installation in cable ducts or control cabinets, length: 1 m

FO patch cable - FL MM PATCH 2,0 LC-ST - 2989271



Assembled FO cable, break out cable, multimode fiberglass 50/125 µm (OM2), connector: LC/B-FOC(ST®), degree of protection: IP20, for installation in cable ducts or control cabinets, length: 2 m

FO converters - PSI-MOS-PROFIB/FO 850 E - 2708274

Accessories

FO patch cable - FL MM PATCH 5,0 LC-ST - 2901801



Assembled FO cable, break out cable, multimode fiberglass 50/125 µm (OM2), connector: LC/B-FOC(ST®), degree of protection: IP20, for installation in cable ducts or control cabinets, length: 5 m

FO patch cable - FL MM PATCH 1,0 SC-ST - 2901809



Assembled FO cable, break out cable, multimode fiberglass 50/125 µm (OM2), connector: SC duplex/B-FOC(ST), degree of protection: IP20, for installation in cable ducts or control cabinets, length: 1 m

FO patch cable - FL MM PATCH 5,0 SC-ST - 2901811



Assembled FO cable, break out cable, multimode fiberglass 50/125 µm (OM2), connector: SC duplex/B-FOC(ST®), degree of protection: IP20, for installation in cable ducts or control cabinets, length: 5 m

FO patch cable - FL MM PATCH 1,0 ST-ST - 2901815



Assembled FO cable, break out cable, multimode fiberglass 50/125 µm (OM2), connector: B-FOC(ST®)/B-FOC(ST®), degree of protection: IP20, for installation in cable ducts or control cabinets, length: 1 m

FO patch cable - FL MM PATCH 2,0 ST-ST - 2901816



Assembled FO cable, break out cable, multimode fiberglass 50/125 µm (OM2), connector: B-FOC(ST®)/B-FOC(ST®), degree of protection: IP20, for installation in cable ducts or control cabinets, length: 2 m

FO converters - PSI-MOS-PROFIB/FO 850 E - 2708274

Accessories

FO patch cable - FL MM PATCH 5,0 ST-ST - 2901817



Assembled FO cable, break out cable, multimode fiberglass 50/125 μm (OM2), connector: B-FOC(ST®)/B-FOC(ST®), degree of protection: IP20, for installation in cable ducts or control cabinets, length: 5 m

FO patch cable - FL MM PATCH 1,0 ST-SCRJ - 2901820



Assembled FO cable, break out cable, multimode fiberglass 50/125 μm (OM2), connector: B-FOC(ST®)/SC-RJ, degree of protection: IP20, for installation in cable ducts or control cabinets, length: 1 m

FO patch cable - FL MM PATCH 2,0 ST-SCRJ - 2901821



Assembled FO cable, break out cable, multimode fiberglass 50/125 μm (OM2), connector: B-FOC(ST®)/SC-RJ, degree of protection: IP20, for installation in cable ducts or control cabinets, length: 2 m

FO patch cable - FL MM PATCH 5,0 ST-SCRJ - 2901822



Assembled FO cable, break out cable, multimode fiberglass 50/125 μm (OM2), connector: B-FOC(ST®)/SC-RJ, degree of protection: IP20, for installation in cable ducts or control cabinets, length: 5 m

FO patch cable - FOC-HCS-RUGGED-1014/IP20/... - 2901555



Robust PCF installation cable for assembly (IP20 heads only) for installation in stationary systems and machines, aramid strain relief elements, with individual elements made from FRNC material, halogen-free, ozone and UV resistant, with a polyurethane (PUR) outer sheath

FO converters - PSI-MOS-PROFIB/FO 850 E - 2708274

Accessories

FO patch cable - FOC-HCS-RUGGED-1014/... - 1402191



rugged PCF installation cable for inner areas with highly tear-proof aramid strain-relief elements. Individual elements made from highly flexible FRNC material. The cable is halogen-free, ozone and UV resistant and has a rugged polyurethane (PUR) outer sheath.

FO patch cable - FOC-HCSO-1015/IP20/... - 2901557



Highly rugged PCF round cable (IP20 heads only) for assembly and for outdoor installation with integrated moisture barrier as well as rodent-proof scrim. Individual elements made from highly flexible FRNC material. The wire is ozone and UV resistant with a very rugged polyethylene outer sheath.

FO patch cable - FOC-GDM-RUGGED-1016/IP20/... - 2901558



Robust GOF installation cable for assembly (IP20 heads only) for installation in stationary systems and machines, aramid strain-relief elements, with individual elements made from FRNC material, halogen-free, ozone and UV resistant, with a polyurethane (PUR) outer sheath

FO patch cable - FOC-GDM-RUGGED-1016/... - 1402193



rugged GOF installation cable for inner areas with highly tear-proof aramid strain-relief elements. Individual elements consist of highly flexible FRNC material. The cable is halogen-free, ozone and UV resistant and has a rugged polyurethane (PUR) outer sheath.

FO patch cable - FOC-GDO-1017/IP20/... - 2901559



Highly rugged GOF round cable (IP20 heads only) for assembly and for outdoor installation with integrated moisture barrier as well as rodent-proof scrim. Individual elements made from highly flexible FRNC material. The wire is ozone and UV resistant with a very rugged polyethylene outer sheath.

Data plug

FO converters - PSI-MOS-PROFIB/FO 850 E - 2708274

Accessories

FO connectors - PSM-SET-B-FOC/4-HCS - 2708481



B-FOC (ST) connector set for PCF fiber, for self assembly consisting of 4 quick mounting connectors with bend protection sleeve

Assembly tool - PSM-HCS-KONFTOOL/B-FOC - 2708465



HCS assembly kit for B-FOC(ST) quick mounting connectors, including stripping blade, stripping pliers, aramide yarn scissors, fiber stripper, microscope, fiber cleaving tool for standard HCS and HCS GI fibers, four B-FOC(ST) connectors for standard HCS fiber, and documentation

Measuring instrument - PSM-FO-POWERMETER - 2799539



Fiber optic measuring case, consisting of an optical power meter, F-SMA, B-FOC adapters, reference fibers and operating instructions

Fiber optic coupling - PSM-SET-BFOC-LINK/2 - 2799429



Coupling; set consisting of 2 couplings for connecting B-FOC plugs

D-SUB bus connector - SUBCON-PLUS-PROFIB/SC2 - 2708232



D-SUB connector, 9-pos., male connector, cable entry < 35°, bus system: PROFIBUS DP up to 12 Mbps, termination resistor can be switched on via slide switch, pin assignment: 3, 5, 6, 8; screw connection terminal blocks

FO converters - PSI-MOS-PROFIB/FO 850 E - 2708274

Accessories

D-SUB bus connector - SUBCON-PLUS-PROFIB/PG/SC2 - 2708245



D-SUB connector, 9-pos., male connector, cable entry < 35°, bus system: PROFIBUS DP up to 12 Mbps with PG D-SUB socket for connecting a programming device, termination resistor can be switched on via slide switch, pin assignment: 3, 5, 6, 8; screw connection terminal blocks

D-SUB bus connector - SUBCON-PLUS-PROFIB/AX/SC - 2744380



D-SUB connector, 9-pos., male connector, axial version with two cable entries, bus system: PROFIBUS DP up to 12 Mbps, termination resistor can be switched on via slide switch, pin assignment: 3, 5, 6, 8; screw connection terminal blocks

Stripping tool - PSM-STRIP-FC/PROFIB - 2744623



Quick stripping tool for PROFIBUS cable, type Fast Connect

D-SUB bus connector - SUBCON-PLUS-PROFIB/90/PG/SC - 2313708



D-SUB connector, 9-pos., male connector, cable entry < 90°, bus system: PROFIBUS DP up to 12 Mbps with PG D-SUB socket for connecting a programming device, termination resistor can be switched on via slide switch, pin assignment: 3, 5, 6, 8; screw connection terminal blocks

D-SUB bus connector - SUBCON-PLUS-PROFIB/90/PG/IDC - 2313685



D-SUB connector, 9-pos., male connector, cable entry < 90°, bus system: PROFIBUS DP up to 12 Mbps with PG D-SUB socket for connecting a programming device, termination resistor can be switched on via slide switch, pin assignment: 3, 5, 6, 8; IDC terminal block connection

FO converters - PSI-MOS-PROFIB/FO 850 E - 2708274

Accessories

D-SUB bus connector - SUBCON-PLUS-PROFIB/AX/M12 - 2902321



D-SUB plug, 9-pos., pin, assignment: 3, 5, 6, 8; two M12 cable glands (B-coded) under 180° (axial). Bus system: PROFIBUS DP up to 12 Mbps. Termination resistor via separate M12 terminator.

D-SUB bus connector - SUBCON-PLUS-PROFIB/90X/M12 - 2902729



D-SUB plug, 9-pos., pin, assignment: 3, 5, 6, 8; two M12 cable glands (B-coded) under 90°. Bus system: PROFIBUS DP up to 12 Mbps. Termination resistor via separate M12 terminator. Long version; S7-compatible.

D-SUB bus connector - SUBCON-PLUS-PROFIB/90/M12 - 2902318



D-SUB plug, 9-pos., pin, assignment: 3, 5, 6, 8; two M12 cable glands (B-coded) under 90°. Bus system: PROFIBUS DP up to 12 Mbps. Termination resistor via separate M12 terminator.

D-SUB bus connector - SUBCON-PLUS-PROFIB/35/M12 - 2902320



D-SUB plug, 9-pos., pin, assignment: 3, 5, 6, 8; two M12 cable glands (B-coded) under 35°. Bus system: PROFIBUS DP up to 12 Mbps. Termination resistor via separate M12 terminator.

DIN rail connector

DIN rail bus connectors - ME 17,5 TBUS 1,5/ 5-ST-3,81 GN - 2709561



DIN rail connector for DIN rail mounting. Universal for TBUS housing. Gold-plated contacts, 5-pos.

FO converters - PSI-MOS-PROFIB/FO 850 E - 2708274

Accessories

DIN rail bus connectors - ME 17,5 TBUS 1,5/PP000-3,81 BK - 2890014



DIN rail connector for DIN rail mounting. Universal for TBUS housing. Gold-plated contacts, 2-pos.

Interface converter

Repeater - PSI-REP-PROFIBUS/12MB - 2708863



Modular repeater for electrical isolation and range increase for PROFIBUS up to 12 Mbps, 4-way isolation, rail-mountable, supply 24 V DC

Repeater - PSM-ME-RS485/RS485-P - 2744429



Repeater, for potential separation and range increase in RS-485 2-wire bus systems, 3-way isolation, rail-mountable

Power supply

Power supply unit - MINI-SYS-PS-100-240AC/24DC/1.5 - 2866983



Primary-switched MINI POWER supply for DIN rail mounting, input: 1-phase, output: 24 V DC/1.5 A

Screwdriver tools

Screwdriver - SZS 0,4X2,5 VDE - 1205037



Screwdriver, slot-headed, VDE insulated, size: 0.4 x 2.5 x 80 mm, 2-component grip, with non-slip grip

Terminal resistor

FO converters - PSI-MOS-PROFIB/FO 850 E - 2708274

Accessories

Termination resistor - PSI-TERMINATOR-PB-TBUS - 2702636



Active termination resistor for PROFIBUS and RS-485 bus systems, redundant power supply, routing of the supply voltage via DIN rail connector, electrical isolation, switchable termination, integrated programming interface

Phoenix Contact 2020 © - all rights reserved
<http://www.phoenixcontact.com>

PHOENIX CONTACT GmbH & Co. KG
Flachsmarktstr. 8
32825 Blomberg
Germany
Tel. +49 5235 300
Fax +49 5235 3 41200
<http://www.phoenixcontact.com>

X-ON Electronics

Largest Supplier of Electrical and Electronic Components

Click to view similar products for [Fibre Optic Transmitters, Receivers, Transceivers](#) category:

Click to view products by [Phoenix Contact](#) manufacturer:

Other Similar products are found below :

[HFBR-1532ETZ](#) [STV.2413-574-00262](#) [TRPRG1VA1C000E2G](#) [TOTX1350\(V,F\)](#) [FTLX3813M349](#) [SCN-1428SC](#) [LTK-ST11MB](#) [HFD8003-002/XBA](#) [HFD3020-500-ABA](#) [FTLF1429P3BCVA](#) [S6846](#) [SCN-2638SC](#) [FTL410QE4N](#) [FTLC9555FEPM](#) [TQS-QG4H9-J83](#) [SCN-1570SC](#) [SCN-1601SC](#) [SCN-1338SC](#) [SFPPT-SR3-01](#) [HFD8003-500-XBA](#) [SCN-1383SC](#) [2333569-1](#) [LNK-ST11HB-R6](#) [FTL4C1QL3L](#) [FTL4C1QE3L](#) [FTL4C1QL3C](#) [1019682](#) [1019683](#) [1019705](#) [HFBR-1415Z](#) [OPF693-2](#) [AFBR-5803ATQZ](#) [AFBR-5803ATZ](#) [PLR135/T9](#) [TGW-Q14BB-FCQ](#) [AFBR-5803AZ](#) [TQS-Q1LH8-XCA03](#) [TQS-Q1LH8-XCA05](#) [TQS-Q1LH8-XCA10](#) [TQS-Q1LH9-2CA](#) [HFBR-1414Z](#) [HFBR-1528Z](#) [HFBR-2406Z](#) [HFBR-2505AZ](#) [HFBR-1532Z](#) [HFBR-1531Z](#) [HFBR-1505AZ](#) [HFBR-1415TZ](#) [HFBR-1404Z](#) [PLT133/T10W](#)