

## Double-level terminal block - UKK 3-MSTB-5,08 - 2770888

Please be informed that the data shown in this PDF Document is generated from our Online Catalog. Please find the complete data in the user's documentation. Our General Terms of Use for Downloads are valid (<http://phoenixcontact.com/download>)



Double-level modular terminal block with COMBICON plug-in zone, nominal current: 12 A, nominal voltage: 250 V, cross section: 0.2 mm<sup>2</sup> - 4 mm<sup>2</sup>, AWG: 24 - 12, mounting type: NS 35/7.5, NS 35/15, NS 32, pitch: 5.08 mm, width: 5.08, color: gray

RoHS

### Key Commercial Data

Packing unit	50 pc
GTIN	
GTIN	4017918068110

### Technical data

#### General

Number of levels	2
Number of connections	4
Color	gray
Insulating material	PA
Flammability rating according to UL 94	V2
Rated surge voltage	4 kV
Degree of pollution	3
Overvoltage category	III
Insulating material group	I
Nominal current I <sub>N</sub>	10 A
Maximum load current	12 A (with 4 mm <sup>2</sup> conductor cross section)
Nominal voltage U <sub>N</sub>	250 V
Open side panel	Yes
Number of positions	1
Shock protection test specification	DIN EN 50274 (VDE 0660-514):2002-11
Back of the hand protection	guaranteed
Finger protection	guaranteed

## Double-level terminal block - UKK 3-MSTB-5,08 - 2770888

### Technical data

#### General

Result of power-frequency withstand voltage test	Test passed
Power frequency withstand voltage setpoint	2.21 kV
Result of bending test	Test passed
Bending test rotation speed	10 rpm
Bending test turns	135
Result of tight fit on support	NS 32/NS 35
Conductor cross section short circuit testing	1 mm <sup>2</sup>
Short-time current	0.12 kA
Ageing test for screwless modular terminal block temperature cycles	192
Result of thermal test	Test passed
Proof of thermal characteristics (needle flame) effective duration	30 s
Relative insulation material temperature index (Elec., UL 746 B)	125 °C
Temperature index of insulation material (DIN EN 60216-1 (VDE 0304-21))	125 °C
Static insulating material application in cold	-40 °C

#### Connection data

Connection labeling	1st and 2nd level connection left
Conductor cross section solid min.	0.2 mm <sup>2</sup>
Conductor cross section solid max.	4 mm <sup>2</sup>
Conductor cross section flexible min.	0.2 mm <sup>2</sup>
Conductor cross section flexible max.	2.5 mm <sup>2</sup>
Conductor cross section AWG min.	24
Conductor cross section AWG max.	12
Conductor cross section flexible, with ferrule without plastic sleeve min.	0.25 mm <sup>2</sup>
Conductor cross section flexible, with ferrule without plastic sleeve max.	2.5 mm <sup>2</sup>
Conductor cross section flexible, with ferrule with plastic sleeve min.	0.25 mm <sup>2</sup>
Conductor cross section flexible, with ferrule with plastic sleeve max.	1.5 mm <sup>2</sup>
2 conductors with same cross section, solid min.	0.2 mm <sup>2</sup>
2 conductors with same cross section, solid max.	1.5 mm <sup>2</sup>
2 conductors with same cross section, stranded min.	0.2 mm <sup>2</sup>
2 conductors with same cross section, stranded max.	1 mm <sup>2</sup>
Two conductors with the same cross section stranded, with ferrule and without plastic sleeve, minimum	0.25 mm <sup>2</sup>
Two conductors with the same cross section stranded, with ferrule and without plastic sleeve, maximum	0.5 mm <sup>2</sup>
Two conductors with the same cross section, flexible, with TWIN ferrules, with plastic sleeve, minimum	0.5 mm <sup>2</sup>
Two conductors with the same cross section, flexible, with TWIN ferrules, with plastic sleeve, maximum	1 mm <sup>2</sup>
Connection method	Screw connection
Stripping length	8 mm
Internal cylindrical gage	A3

## Double-level terminal block - UKK 3-MSTB-5,08 - 2770888

### Technical data

#### Connection data

Screw thread	M3
Tightening torque, min	0.5 Nm
Tightening torque max	0.6 Nm

#### Standards and Regulations

Connection in acc. with standard	CSA
Flammability rating according to UL 94	V2

#### Environmental Product Compliance

REACH SVHC	Lead 7439-92-1
China RoHS	Environmentally Friendly Use Period = 50 years
	For details about hazardous substances go to tab "Downloads", Category "Manufacturer's declaration"

### Drawings

Dimensional drawing

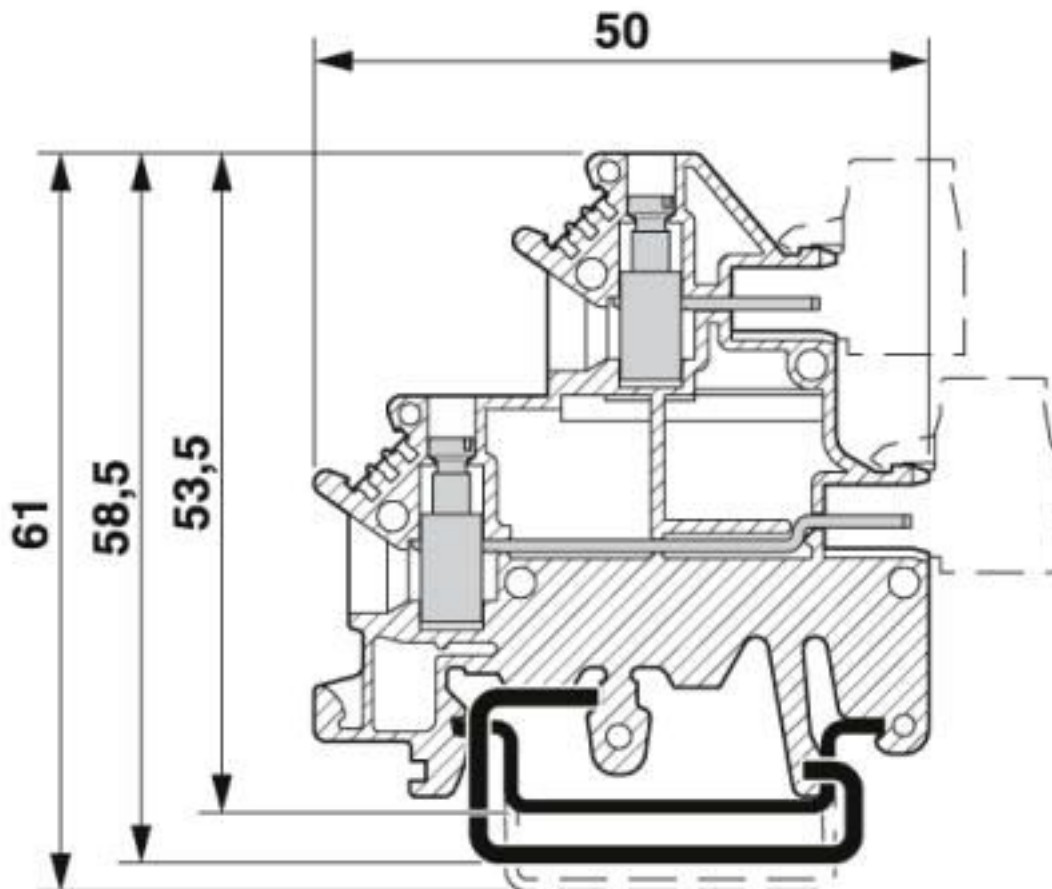

# Double-level terminal block - UKK 3-MSTB-5,08 - 2770888

## Classifications

### eCl@ss

eCl@ss 10.0.1	27141120
eCl@ss 4.0	27141100
eCl@ss 4.1	27141100
eCl@ss 5.0	27141100
eCl@ss 5.1	27141100
eCl@ss 6.0	27141100
eCl@ss 7.0	27141120
eCl@ss 8.0	27141120
eCl@ss 9.0	27141120

### ETIM

ETIM 2.0	EC000897
ETIM 3.0	EC000897
ETIM 4.0	EC000897
ETIM 5.0	EC000897
ETIM 6.0	EC000897
ETIM 7.0	EC000897

### UNSPSC

UNSPSC 6.01	30211811
UNSPSC 7.0901	39121410
UNSPSC 11	39121410
UNSPSC 12.01	39121410
UNSPSC 13.2	39121410
UNSPSC 18.0	39121410
UNSPSC 19.0	39121410
UNSPSC 20.0	39121410
UNSPSC 21.0	39121410

## Approvals

### Approvals

---

#### Approvals

CSA / UL Recognized / cUL Recognized / IECCE CB Scheme / VDE Gutachten mit Fertigungsüberwachung / EAC / EAC / cULus Recognized

---

#### Ex Approvals

---

### Approval details

# Double-level terminal block - UKK 3-MSTB-5,08 - 2770888

## Approvals

CSA		<a href="http://www.csagroup.org/services-industries/product-listing/">http://www.csagroup.org/services-industries/product-listing/</a>	13631
Nominal voltage UN		300 V	
Nominal current IN		10 A	
mm <sup>2</sup> /AWG/kcmil		28-12	

UL Recognized		<a href="http://database.ul.com/cgi-bin/XYV/template/LISEXT/1FRAME/index.htm">http://database.ul.com/cgi-bin/XYV/template/LISEXT/1FRAME/index.htm</a>	FILE E 60425
	B	D	
Nominal voltage UN	300 V	300 V	
Nominal current IN	10 A	10 A	
mm <sup>2</sup> /AWG/kcmil	30-12	30-12	

cUL Recognized		<a href="http://database.ul.com/cgi-bin/XYV/template/LISEXT/1FRAME/index.htm">http://database.ul.com/cgi-bin/XYV/template/LISEXT/1FRAME/index.htm</a>	FILE E 60425
	B	D	
Nominal voltage UN	300 V	300 V	
Nominal current IN	10 A	10 A	
mm <sup>2</sup> /AWG/kcmil	30-12	30-12	

IECEE CB Scheme		<a href="http://www.iecee.org/">http://www.iecee.org/</a>	DE1-60988-B1B2
Nominal voltage UN		250 V	
Nominal current IN		12 A	
mm <sup>2</sup> /AWG/kcmil		0.2-4	

VDE Gutachten mit Fertigungsüberwachung		<a href="http://www2.vde.com/de/Institut/Online-Service/VDE-gepruefteProdukte/Seiten/Online-Suche.aspx">http://www2.vde.com/de/Institut/Online-Service/VDE-gepruefteProdukte/Seiten/Online-Suche.aspx</a>	40047172
Nominal voltage UN		250 V	
Nominal current IN		12 A	
mm <sup>2</sup> /AWG/kcmil		0.2-2.5	

## Double-level terminal block - UKK 3-MSTB-5,08 - 2770888

### Approvals

EAC		RU C- DE.A*30.B.01742
-----	--	--------------------------

EAC		RU C- DE.BL08.B.00534
-----	--	--------------------------

cULus Recognized		
------------------	--	--

### Accessories

#### Accessories

##### DIN rail

DIN rail perforated - NS 32 PERF 2000MM - 1201002



DIN rail perforated, G profile, width: 32 mm, height: 15 mm, acc. to EN 60715, material: Steel, galvanized, passivated with a thick layer, length: 2000 mm, color: silver

DIN rail, unperforated - NS 32 UNPERF 2000MM - 1201015



DIN rail, unperforated, G profile, width: 32 mm, height: 15 mm, acc. to EN 60715, material: Steel, galvanized, passivated with a thick layer, length: 2000 mm, color: silver

DIN rail perforated - NS 35/ 7,5 PERF 2000MM - 0801733



DIN rail perforated, Standard profile, width: 35 mm, height: 7.5 mm, acc. to EN 60715, material: Steel, galvanized, passivated with a thick layer, length: 2000 mm, color: silver

## Double-level terminal block - UKK 3-MSTB-5,08 - 2770888

### Accessories

DIN rail, unperforated - NS 35/ 7,5 UNPERF 2000MM - 0801681



DIN rail, unperforated, Standard profile, width: 35 mm, height: 7.5 mm, acc. to EN 60715, material: Steel, galvanized, passivated with a thick layer, length: 2000 mm, color: silver

DIN rail perforated - NS 35/ 7,5 WH PERF 2000MM - 1204119



DIN rail perforated, Standard profile, width: 35 mm, height: 7.5 mm, acc. to EN 60715, material: Steel, Galvanized, white passivated, length: 2000 mm, color: silver

DIN rail, unperforated - NS 35/ 7,5 WH UNPERF 2000MM - 1204122



DIN rail, unperforated, Standard profile, width: 35 mm, height: 7.5 mm, acc. to EN 60715, material: Steel, Galvanized, white passivated, length: 2000 mm, color: silver

DIN rail, unperforated - NS 35/ 7,5 AL UNPERF 2000MM - 0801704



DIN rail, unperforated, Standard profile, width: 35 mm, height: 7.5 mm, acc. to EN 60715, material: Aluminum, uncoated, length: 2000 mm, color: silver

DIN rail perforated - NS 35/ 7,5 ZN PERF 2000MM - 1206421



DIN rail perforated, Standard profile, width: 35 mm, height: 7.5 mm, acc. to EN 60715, material: Steel, galvanized, length: 2000 mm, color: silver

## Double-level terminal block - UKK 3-MSTB-5,08 - 2770888

### Accessories

DIN rail, unperforated - NS 35/ 7,5 ZN UNPERF 2000MM - 1206434



DIN rail, unperforated, Standard profile, width: 35 mm, height: 7.5 mm, acc. to EN 60715, material: Steel, galvanized, length: 2000 mm, color: silver

---

DIN rail, unperforated - NS 35/ 7,5 CU UNPERF 2000MM - 0801762



DIN rail, unperforated, Standard profile, width: 35 mm, height: 7.5 mm, acc. to EN 60715, material: Copper, uncoated, length: 2000 mm, color: copper-colored

---

End cap - NS 35/ 7,5 CAP - 1206560



DIN rail end piece, for DIN rail NS 35/7.5

---

DIN rail perforated - NS 35/15 PERF 2000MM - 1201730



DIN rail perforated, Standard profile, width: 35 mm, height: 15 mm, similar to EN 60715, material: Steel, galvanized, passivated with a thick layer, length: 2000 mm, color: silver

---

DIN rail, unperforated - NS 35/15 UNPERF 2000MM - 1201714

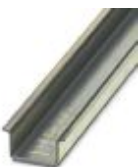

DIN rail, unperforated, Standard profile, width: 35 mm, height: 15 mm, similar to EN 60715, material: Steel, galvanized, passivated with a thick layer, length: 2000 mm, color: silver

---



## Double-level terminal block - UKK 3-MSTB-5,08 - 2770888

### Accessories

DIN rail perforated - NS 35/15 WH PERF 2000MM - 0806602



DIN rail perforated, Standard profile, width: 35 mm, height: 15 mm, similar to EN 60715, material: Steel, Galvanized, white passivated, length: 2000 mm, color: silver

---

DIN rail, unperforated - NS 35/15 WH UNPERF 2000MM - 1204135



DIN rail, unperforated, Standard profile, width: 35 mm, height: 15 mm, similar to EN 60715, material: Steel, Galvanized, white passivated, length: 2000 mm, color: silver

---

DIN rail, unperforated - NS 35/15 AL UNPERF 2000MM - 1201756



DIN rail, unperforated, Standard profile, width: 35 mm, height: 15 mm, similar to EN 60715, material: Aluminum, uncoated, length: 2000 mm, color: silver

---

DIN rail perforated - NS 35/15 ZN PERF 2000MM - 1206599



DIN rail perforated, Standard profile, width: 35 mm, height: 15 mm, similar to EN 60715, material: Steel, galvanized, length: 2000 mm, color: silver

---

DIN rail, unperforated - NS 35/15 ZN UNPERF 2000MM - 1206586



DIN rail, unperforated, Standard profile, width: 35 mm, height: 15 mm, similar to EN 60715, material: Steel, galvanized, length: 2000 mm, color: silver

---

## Double-level terminal block - UKK 3-MSTB-5,08 - 2770888

### Accessories

DIN rail, unperforated - NS 35/15 CU UNPERF 2000MM - 1201895



DIN rail, unperforated, Standard profile, width: 35 mm, height: 15 mm, similar to EN 60715, material: Copper, uncoated, length: 2000 mm, color: copper-colored

---

End cap - NS 35/15 CAP - 1206573



DIN rail end piece, for DIN rail NS 35/15

---

DIN rail, unperforated - NS 35/15-2,3 UNPERF 2000MM - 1201798



DIN rail, unperforated, Standard profile 2.3 mm, width: 35 mm, height: 15 mm, acc. to EN 60715, material: Steel, galvanized, passivated with a thick layer, length: 2000 mm, color: silver

---

End block

End clamp - CLIPFIX 35 - 3022218



Quick mounting end clamp for NS 35/7,5 DIN rail or NS 35/15 DIN rail, with marking option, width: 9.5 mm, color: gray

---

End clamp - CLIPFIX 35-5 - 3022276



Quick mounting end clamp for NS 35/7,5 DIN rail or NS 35/15 DIN rail, with marking option, with parking option for FBS...5, FBS...6, KSS 5, KSS 6, width: 5.15 mm, color: gray

---

## Double-level terminal block - UKK 3-MSTB-5,08 - 2770888

### Accessories

End clamp - E/NS 35 N - 0800886



End clamp, width: 9.5 mm, color: gray

---

End clamp - E/UK - 1201442



End clamp, width: 9.5 mm, height: 35.3 mm, material: PA, length: 50.5 mm, Mounting on a DIN rail NS 32 or NS 35, color: gray

---

End clamp - E/UK 1 - 1201413



End clamps, for supporting the ends of double-level and three-level terminal blocks, width: 10 mm, color: gray

---

End cover

End cover - DG-UKK 3-MSTB-5,08 - 2770613

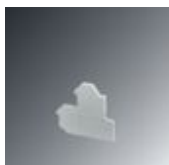

End cover, pitch: 5.08 mm, width: 2.2 mm, number of positions: 1, color: gray

---

End cover - D-UKK 3-MSTB-5,08 L - 2770914



End cover, pitch: 5.08 mm, length: 50 mm, width: 2.5 mm, height: 42.3 mm, number of positions: 1, color: gray

---

## Double-level terminal block - UKK 3-MSTB-5,08 - 2770888

### Accessories

End cover - D-UKK 3-MSTB-5,08 - 2770891



End cover, pitch: 5.08 mm, length: 50 mm, width: 2.5 mm, height: 53.5 mm, number of positions: 1, color: gray

---

### Insertion bridge

Insertion bridge - EBL 2- 5 - 2303145



Insertion bridge, pitch: 5.2 mm, number of positions: 2, color: gray

---

Insertion bridge - EBL 3- 5 - 2303158



Insertion bridge, pitch: 5.2 mm, number of positions: 3, color: gray

---

### Labeled terminal marker

Zack marker strip - ZB 5,08 CUS - 0824963



Zack marker strip, can be ordered: Strip, white, labeled according to customer specifications, mounting type: snap into tall marker groove, for terminal block width: 5.08 mm, lettering field size: 4.98 x 10.5 mm, Number of individual labels: 10

---

Zack marker strip - ZB 5,08,LGS:FORTL.ZAHLEN - 0809803



Zack marker strip, Strip, white, labeled, printed horizontally: consecutive numbers 1 ... 10, 11 ... 20, etc. up to 91 ... 100, mounting type: snap into tall marker groove, for terminal block width: 5.08 mm, lettering field size: 4.98 x 10.5 mm, Number of individual labels: 10

---

## Double-level terminal block - UKK 3-MSTB-5,08 - 2770888

### Accessories

Zack marker strip - ZB 5,08,QR:FORTL.ZAHLEN - 0809858



Zack marker strip, Strip, white, labeled, Printed vertically: consecutive numbers 1 ... 10, 11 ... 20, etc. up to 91 ... 100, mounting type: snap into tall marker groove, for terminal block width: 5.08 mm, lettering field size: 10.5 x 5.15 mm, Number of individual labels: 10

Zack marker strip - ZB 5,08,LGS:L1-N,PE - 0809832



Zack marker strip, Strip, white, labeled, printed horizontally: L1, L2, L3, N, PE, L1, L2, L3, N, PE, mounting type: snap into tall marker groove, for terminal block width: 5.08 mm, lettering field size: 10.5 x 5.15 mm, Number of individual labels: 10

Zack marker strip - ZB 5,08,LGS:U-N - 0809845



Zack marker strip, Strip, white, labeled, printed horizontally: U, V, W, N, GND, U, V, W, N, GND, mounting type: snap into tall marker groove, for terminal block width: 5.08 mm, lettering field size: 10.5 x 5.15 mm, Number of individual labels: 10

### Partition plate

Spacer plate - DP-UKK 3-MSTB-5,08 - 2770600



Spacer plate, to compensate for level offsets, pitch: 5.08 mm, length: 50 mm, width: 2.5 mm, number of positions: 1, color: gray

### Screwdriver tools

Screwdriver - SZS 0,6X3,5 - 1205053



Actuation tool, for ST terminal blocks, insulated, also suitable for use as a bladed screwdriver, size: 0.6 x 3.5 x 100 mm, 2-component grip, with non-slip grip

### Terminal marking

## Double-level terminal block - UKK 3-MSTB-5,08 - 2770888

### Accessories

Zack marker strip - ZB 5,08:UNBEDRUCKT - 0809793



Zack marker strip, Strip, white, unlabeled, can be labeled with: PLOTMARK, CMS-P1-PLOTTER, mounting type: snap into tall marker groove, for terminal block width: 5.08 mm, lettering field size: 4.98 x 10.5 mm, Number of individual labels: 10

---

### Additional products

Printed-circuit board connector - MSTB 2,5/10-ST-5,08 - 1757093



PCB connector, nominal current: 12 A, rated voltage (III/2): 320 V, nominal cross section: 2.5 mm<sup>2</sup>, number of positions: 10, pitch: 5.08 mm, connection method: Screw connection with tension sleeve, color: green, contact surface: Tin

---

Printed-circuit board connector - MSTB 2,5/11-ST-5,08 - 1757103



PCB connector, nominal current: 12 A, rated voltage (III/2): 320 V, nominal cross section: 2.5 mm<sup>2</sup>, number of positions: 11, pitch: 5.08 mm, connection method: Screw connection with tension sleeve, color: green, contact surface: Tin

---

Printed-circuit board connector - MSTB 2,5/15-ST-5,08 - 1757145



PCB connector, nominal current: 12 A, rated voltage (III/2): 320 V, nominal cross section: 2.5 mm<sup>2</sup>, number of positions: 15, pitch: 5.08 mm, connection method: Screw connection with tension sleeve, color: green, contact surface: Tin

---

Printed-circuit board connector - MSTB 2,5/16-ST-5,08 - 1757158



PCB connector, nominal current: 12 A, rated voltage (III/2): 320 V, nominal cross section: 2.5 mm<sup>2</sup>, number of positions: 16, pitch: 5.08 mm, connection method: Screw connection with tension sleeve, color: green, contact surface: Tin

## Double-level terminal block - UKK 3-MSTB-5,08 - 2770888

### Accessories

#### Printed-circuit board connector - MSTB 2,5/18-ST-5,08 - 1757174

PCB connector, nominal current: 12 A, rated voltage (III/2): 320 V, nominal cross section: 2.5 mm<sup>2</sup>, number of positions: 18, pitch: 5.08 mm, connection method: Screw connection with tension sleeve, color: green, contact surface: Tin



#### Printed-circuit board connector - MSTB 2,5/20-ST-5,08 - 1757190

PCB connector, nominal current: 12 A, rated voltage (III/2): 320 V, nominal cross section: 2.5 mm<sup>2</sup>, number of positions: 20, pitch: 5.08 mm, connection method: Screw connection with tension sleeve, color: green, contact surface: Tin



#### Printed-circuit board connector - MSTB 2,5/ 2-ST-5,08 - 1757019

PCB connector, nominal current: 12 A, rated voltage (III/2): 320 V, nominal cross section: 2.5 mm<sup>2</sup>, number of positions: 2, pitch: 5.08 mm, connection method: Screw connection with tension sleeve, color: green, contact surface: Tin



#### Printed-circuit board connector - MSTB 2,5/ 9-ST-5,08 - 1757080

PCB connector, nominal current: 12 A, rated voltage (III/2): 320 V, nominal cross section: 2.5 mm<sup>2</sup>, number of positions: 9, pitch: 5.08 mm, connection method: Screw connection with tension sleeve, color: green, contact surface: Tin



#### Printed-circuit board connector - MSTB 2,5/ 7-STZ-5,08 - 1776113

PCB connector, nominal current: 12 A, rated voltage (III/2): 320 V, nominal cross section: 2.5 mm<sup>2</sup>, number of positions: 7, pitch: 5.08 mm, connection method: Screw connection with tension sleeve, color: green, contact surface: Tin



## Double-level terminal block - UKK 3-MSTB-5,08 - 2770888

### Accessories

Printed-circuit board connector - MSTB 2,5/ 5-STZ-5,08 - 1776142



PCB connector, nominal current: 12 A, rated voltage (III/2): 320 V, nominal cross section: 2.5 mm<sup>2</sup>, number of positions: 5, pitch: 5.08 mm, connection method: Screw connection with tension sleeve, color: green, contact surface: Tin

---

Printed-circuit board connector - MSTB 2,5/ 4-STZ-5,08 - 1776155



PCB connector, nominal current: 12 A, rated voltage (III/2): 320 V, nominal cross section: 2.5 mm<sup>2</sup>, number of positions: 4, pitch: 5.08 mm, connection method: Screw connection with tension sleeve, color: green, contact surface: Tin

---

Printed-circuit board connector - MSTB 2,5/12-STZ-5,08 - 1764280



PCB connector, nominal current: 12 A, rated voltage (III/2): 320 V, nominal cross section: 2.5 mm<sup>2</sup>, number of positions: 12, pitch: 5.08 mm, connection method: Screw connection with tension sleeve, color: green, contact surface: Tin

---

Printed-circuit board connector - MSTB 2,5/ 6-STZ-5,08 - 1776126



PCB connector, nominal current: 12 A, rated voltage (III/2): 320 V, nominal cross section: 2.5 mm<sup>2</sup>, number of positions: 6, pitch: 5.08 mm, connection method: Screw connection with tension sleeve, color: green, contact surface: Tin

---

Printed-circuit board connector - MSTB 2,5/16-STZ-5,08 - 1764248



PCB connector, nominal current: 12 A, rated voltage (III/2): 320 V, nominal cross section: 2.5 mm<sup>2</sup>, number of positions: 16, pitch: 5.08 mm, connection method: Screw connection with tension sleeve, color: green, contact surface: Tin

---



## Double-level terminal block - UKK 3-MSTB-5,08 - 2770888

### Accessories

#### Printed-circuit board connector - MSTB 2,5/ 9-STZ-5,08 - 1764316



PCB connector, nominal current: 12 A, rated voltage (III/2): 320 V, nominal cross section: 2.5 mm<sup>2</sup>, number of positions: 9, pitch: 5.08 mm, connection method: Screw connection with tension sleeve, color: green, contact surface: Tin

---

#### Printed-circuit board connector - MSTBP 2,5/ 4-ST-5,08 - 1769036



PCB connector, nominal current: 12 A, rated voltage (III/2): 320 V, nominal cross section: 2.5 mm<sup>2</sup>, number of positions: 4, pitch: 5.08 mm, connection method: Screw connection with tension sleeve, color: green, contact surface: Tin

---

#### Printed-circuit board connector - MSTBP 2,5/16-ST-5,08 - 1769159



PCB connector, nominal current: 12 A, rated voltage (III/2): 320 V, nominal cross section: 2.5 mm<sup>2</sup>, number of positions: 16, pitch: 5.08 mm, connection method: Screw connection with tension sleeve, color: green, contact surface: Tin

---

#### Printed-circuit board connector - MSTBP 2,5/ 6-ST-5,08 - 1769052



PCB connector, nominal current: 12 A, rated voltage (III/2): 320 V, nominal cross section: 2.5 mm<sup>2</sup>, number of positions: 6, pitch: 5.08 mm, connection method: Screw connection with tension sleeve, color: green, contact surface: Tin

---

#### Printed-circuit board connector - MSTBP 2,5/17-ST-5,08 - 1769162



PCB connector, nominal current: 12 A, rated voltage (III/2): 320 V, nominal cross section: 2.5 mm<sup>2</sup>, number of positions: 17, pitch: 5.08 mm, connection method: Screw connection with tension sleeve, color: green, contact surface: Tin

## Double-level terminal block - UKK 3-MSTB-5,08 - 2770888

### Accessories

#### Printed-circuit board connector - MSTBP 2,5/24-ST-5,08 - 1769696

PCB connector, nominal current: 12 A, rated voltage (III/2): 320 V, nominal cross section: 2.5 mm<sup>2</sup>, number of positions: 24, pitch: 5.08 mm, connection method: Screw connection with tension sleeve, color: green, contact surface: Tin



#### Printed-circuit board connector - MSTBP 2,5/ 8-ST-5,08 - 1769078

PCB connector, nominal current: 12 A, rated voltage (III/2): 320 V, nominal cross section: 2.5 mm<sup>2</sup>, number of positions: 8, pitch: 5.08 mm, connection method: Screw connection with tension sleeve, color: green, contact surface: Tin



#### Printed-circuit board connector - MSTBP 2,5/ 9-ST-5,08 - 1769081

PCB connector, nominal current: 12 A, rated voltage (III/2): 320 V, nominal cross section: 2.5 mm<sup>2</sup>, number of positions: 9, pitch: 5.08 mm, connection method: Screw connection with tension sleeve, color: green, contact surface: Tin



#### Printed-circuit board connector - MSTBP 2,5/13-ST-5,08 - 1769120

PCB connector, nominal current: 12 A, rated voltage (III/2): 320 V, nominal cross section: 2.5 mm<sup>2</sup>, number of positions: 13, pitch: 5.08 mm, connection method: Screw connection with tension sleeve, color: green, contact surface: Tin



#### Printed-circuit board connector - MSTBP 2,5/20-ST-5,08 - 1769191

PCB connector, nominal current: 12 A, rated voltage (III/2): 320 V, nominal cross section: 2.5 mm<sup>2</sup>, number of positions: 20, pitch: 5.08 mm, connection method: Screw connection with tension sleeve, color: green, contact surface: Tin



## Double-level terminal block - UKK 3-MSTB-5,08 - 2770888

### Accessories

#### Printed-circuit board connector - MSTBT 2,5/15-ST-5,08 - 1781111

PCB connector, nominal current: 12 A, rated voltage (III/2): 320 V, nominal cross section: 2.5 mm<sup>2</sup>, number of positions: 15, pitch: 5.08 mm, connection method: Screw connection with tension sleeve, color: green, contact surface: Tin



#### Printed-circuit board connector - MSTBT 2,5/ 3-ST-5,08 - 1779990

PCB connector, nominal current: 12 A, rated voltage (III/2): 320 V, nominal cross section: 2.5 mm<sup>2</sup>, number of positions: 3, pitch: 5.08 mm, connection method: Screw connection with tension sleeve, color: green, contact surface: Tin



#### Printed-circuit board connector - MSTBT 2,5/16-ST-5,08 - 1781124

PCB connector, nominal current: 12 A, rated voltage (III/2): 320 V, nominal cross section: 2.5 mm<sup>2</sup>, number of positions: 16, pitch: 5.08 mm, connection method: Screw connection with tension sleeve, color: green, contact surface: Tin



#### Printed-circuit board connector - SMSTB 2,5/ 4-ST-5,08 - 1826306

PCB connector, nominal current: 12 A, rated voltage (III/2): 320 V, nominal cross section: 2.5 mm<sup>2</sup>, number of positions: 4, pitch: 5.08 mm, connection method: Screw connection with tension sleeve, color: green, contact surface: Tin



#### Printed-circuit board connector - SMSTB 2,5/ 5-ST-5,08 - 1826319

PCB connector, nominal current: 12 A, rated voltage (III/2): 320 V, nominal cross section: 2.5 mm<sup>2</sup>, number of positions: 5, pitch: 5.08 mm, connection method: Screw connection with tension sleeve, color: green, contact surface: Tin



## Double-level terminal block - UKK 3-MSTB-5,08 - 2770888

### Accessories

#### Printed-circuit board connector - SMSTB 2,5/10-ST-5,08 - 1826364

PCB connector, nominal current: 12 A, rated voltage (III/2): 320 V, nominal cross section: 2.5 mm<sup>2</sup>, number of positions: 10, pitch: 5.08 mm, connection method: Screw connection with tension sleeve, color: green, contact surface: Tin



---

#### Printed-circuit board connector - SMSTB 2,5/12-ST-5,08 - 1826380

PCB connector, nominal current: 12 A, rated voltage (III/2): 320 V, nominal cross section: 2.5 mm<sup>2</sup>, number of positions: 12, pitch: 5.08 mm, connection method: Screw connection with tension sleeve, color: green, contact surface: Tin



---

#### Printed-circuit board connector - SMSTB 2,5/15-ST-5,08 - 1826416

PCB connector, nominal current: 12 A, rated voltage (III/2): 320 V, nominal cross section: 2.5 mm<sup>2</sup>, number of positions: 15, pitch: 5.08 mm, connection method: Screw connection with tension sleeve, color: green, contact surface: Tin



---

#### Printed-circuit board connector - SMSTB 2,5/16-ST-5,08 - 1826429

PCB connector, nominal current: 12 A, rated voltage (III/2): 320 V, nominal cross section: 2.5 mm<sup>2</sup>, number of positions: 16, pitch: 5.08 mm, connection method: Screw connection with tension sleeve, color: green, contact surface: Tin



---

#### Printed-circuit board connector - SMSTB 2,5/19-ST-5,08 - 1850589

PCB connector, nominal current: 12 A, rated voltage (III/2): 320 V, nominal cross section: 2.5 mm<sup>2</sup>, number of positions: 19, pitch: 5.08 mm, connection method: Screw connection with tension sleeve, color: green, contact surface: Tin



## Double-level terminal block - UKK 3-MSTB-5,08 - 2770888

### Accessories

#### Printed-circuit board connector - SMSTB 2,5/20-ST-5,08 - 1850592

PCB connector, nominal current: 12 A, rated voltage (III/2): 320 V, nominal cross section: 2.5 mm<sup>2</sup>, number of positions: 20, pitch: 5.08 mm, connection method: Screw connection with tension sleeve, color: green, contact surface: Tin



---

#### Printed-circuit board connector - SMSTB 2,5/23-ST-5,08 - 1850628

PCB connector, nominal current: 12 A, rated voltage (III/2): 320 V, nominal cross section: 2.5 mm<sup>2</sup>, number of positions: 23, pitch: 5.08 mm, connection method: Screw connection with tension sleeve, color: green, contact surface: Tin



---

#### Printed-circuit board connector - SMSTB 2,5/21-ST-5,08 - 1850602

PCB connector, nominal current: 12 A, rated voltage (III/2): 320 V, nominal cross section: 2.5 mm<sup>2</sup>, number of positions: 21, pitch: 5.08 mm, connection method: Screw connection with tension sleeve, color: green, contact surface: Tin



---

#### Printed-circuit board connector - SMSTB 2,5/14-ST-5,08 - 1826403

PCB connector, nominal current: 12 A, rated voltage (III/2): 320 V, nominal cross section: 2.5 mm<sup>2</sup>, number of positions: 14, pitch: 5.08 mm, connection method: Screw connection with tension sleeve, color: green, contact surface: Tin



---

#### Printed-circuit board connector - SMSTB 2,5/ 7-ST-5,08 - 1826335

PCB connector, nominal current: 12 A, rated voltage (III/2): 320 V, nominal cross section: 2.5 mm<sup>2</sup>, number of positions: 7, pitch: 5.08 mm, connection method: Screw connection with tension sleeve, color: green, contact surface: Tin



## Double-level terminal block - UKK 3-MSTB-5,08 - 2770888

### Accessories

#### Printed-circuit board connector - SMSTB 2,5/17-ST-5,08 - 1850563

PCB connector, nominal current: 12 A, rated voltage (III/2): 320 V, nominal cross section: 2.5 mm<sup>2</sup>, number of positions: 17, pitch: 5.08 mm, connection method: Screw connection with tension sleeve, color: green, contact surface: Tin



---

#### Printed-circuit board connector - SMSTB 2,5/ 2-ST-5,08 - 1826283

PCB connector, nominal current: 12 A, rated voltage (III/2): 320 V, nominal cross section: 2.5 mm<sup>2</sup>, number of positions: 2, pitch: 5.08 mm, connection method: Screw connection with tension sleeve, color: green, contact surface: Tin



---

#### Printed-circuit board connector - SMSTB 2,5/ 3-ST-5,08 - 1826296

PCB connector, nominal current: 12 A, rated voltage (III/2): 320 V, nominal cross section: 2.5 mm<sup>2</sup>, number of positions: 3, pitch: 5.08 mm, connection method: Screw connection with tension sleeve, color: green, contact surface: Tin



---

#### Printed-circuit board connector - SMSTB 2,5/ 6-ST-5,08 - 1826322

PCB connector, nominal current: 12 A, rated voltage (III/2): 320 V, nominal cross section: 2.5 mm<sup>2</sup>, number of positions: 6, pitch: 5.08 mm, connection method: Screw connection with tension sleeve, color: green, contact surface: Tin



---

#### Printed-circuit board connector - SMSTB 2,5/22-ST-5,08 - 1850615

PCB connector, nominal current: 12 A, rated voltage (III/2): 320 V, nominal cross section: 2.5 mm<sup>2</sup>, number of positions: 22, pitch: 5.08 mm, connection method: Screw connection with tension sleeve, color: green, contact surface: Tin



## Double-level terminal block - UKK 3-MSTB-5,08 - 2770888

### Accessories

#### Printed-circuit board connector - SMSTB 2,5/24-ST-5,08 - 1850631

PCB connector, nominal current: 12 A, rated voltage (III/2): 320 V, nominal cross section: 2.5 mm<sup>2</sup>, number of positions: 24, pitch: 5.08 mm, connection method: Screw connection with tension sleeve, color: green, contact surface: Tin



#### Printed-circuit board connector - FRONT-MSTB 2,5/ 2-ST-5,08 - 1777280

PCB connector, nominal current: 12 A, rated voltage (III/2): 320 V, nominal cross section: 2.5 mm<sup>2</sup>, number of positions: 2, pitch: 5.08 mm, connection method: Front screw connection, color: green, contact surface: Tin



#### Printed-circuit board connector - FRONT-MSTB 2,5/ 6-ST-5,08 - 1777329

PCB connector, nominal current: 12 A, rated voltage (III/2): 320 V, nominal cross section: 2.5 mm<sup>2</sup>, number of positions: 6, pitch: 5.08 mm, connection method: Front screw connection, color: green, contact surface: Tin



#### Printed-circuit board connector - FRONT-MSTB 2,5/ 8-ST-5,08 - 1777345

PCB connector, nominal current: 12 A, rated voltage (III/2): 320 V, nominal cross section: 2.5 mm<sup>2</sup>, number of positions: 8, pitch: 5.08 mm, connection method: Front screw connection, color: green, contact surface: Tin



#### Printed-circuit board connector - FRONT-MSTB 2,5/10-ST-5,08 - 1777361

PCB connector, nominal current: 12 A, rated voltage (III/2): 320 V, nominal cross section: 2.5 mm<sup>2</sup>, number of positions: 10, pitch: 5.08 mm, connection method: Front screw connection, color: green, contact surface: Tin



## Double-level terminal block - UKK 3-MSTB-5,08 - 2770888

### Accessories

Printed-circuit board connector - FRONT-MSTB 2,5/13-ST-5,08 - 1777390

PCB connector, nominal current: 12 A, rated voltage (III/2): 320 V, nominal cross section: 2.5 mm<sup>2</sup>, number of positions: 13, pitch: 5.08 mm, connection method: Front screw connection, color: green, contact surface: Tin



Printed-circuit board connector - FRONT-MSTB 2,5/14-ST-5,08 - 1777400

PCB connector, nominal current: 12 A, rated voltage (III/2): 320 V, nominal cross section: 2.5 mm<sup>2</sup>, number of positions: 14, pitch: 5.08 mm, connection method: Front screw connection, color: green, contact surface: Tin



Printed-circuit board connector - FRONT-MSTB 2,5/16-ST-5,08 - 1777426

PCB connector, nominal current: 12 A, rated voltage (III/2): 320 V, nominal cross section: 2.5 mm<sup>2</sup>, number of positions: 16, pitch: 5.08 mm, connection method: Front screw connection, color: green, contact surface: Tin



Printed-circuit board connector - FRONT-MSTB 2,5/22-ST-5,08 - 1777484

PCB connector, nominal current: 12 A, rated voltage (III/2): 320 V, nominal cross section: 2.5 mm<sup>2</sup>, number of positions: 22, pitch: 5.08 mm, connection method: Front screw connection, color: green, contact surface: Tin



Plug - FRONT-MSTB 2,5/24-ST-5,08 - 1777507

PCB connector, nominal current: 12 A, rated voltage (III/2): 320 V, nominal cross section: 2.5 mm<sup>2</sup>, number of positions: 24, pitch: 5.08 mm, connection method: Front screw connection, color: green, contact surface: Tin





## Double-level terminal block - UKK 3-MSTB-5,08 - 2770888

### Accessories

Printed-circuit board connector - FRONT-MSTB 2,5/11-ST-5,08 - 1777374

PCB connector, nominal current: 12 A, rated voltage (III/2): 320 V, nominal cross section: 2.5 mm<sup>2</sup>, number of positions: 11, pitch: 5.08 mm, connection method: Front screw connection, color: green, contact surface: Tin



Printed-circuit board connector - FRONT-MSTB 2,5/17-ST-5,08 - 1777439

PCB connector, nominal current: 12 A, rated voltage (III/2): 320 V, nominal cross section: 2.5 mm<sup>2</sup>, number of positions: 17, pitch: 5.08 mm, connection method: Front screw connection, color: green, contact surface: Tin



Printed-circuit board connector - FRONT-MSTB 2,5/ 3-ST-5,08 - 1777293

PCB connector, nominal current: 12 A, rated voltage (III/2): 320 V, nominal cross section: 2.5 mm<sup>2</sup>, number of positions: 3, pitch: 5.08 mm, connection method: Front screw connection, color: green, contact surface: Tin



Printed-circuit board connector - FRONT-MSTB 2,5/19-ST-5,08 - 1777455

PCB connector, nominal current: 12 A, rated voltage (III/2): 320 V, nominal cross section: 2.5 mm<sup>2</sup>, number of positions: 19, pitch: 5.08 mm, connection method: Front screw connection, color: green, contact surface: Tin



Printed-circuit board connector - FRONT-MSTB 2,5/21-ST-5,08 - 1777471

PCB connector, nominal current: 12 A, rated voltage (III/2): 320 V, nominal cross section: 2.5 mm<sup>2</sup>, number of positions: 21, pitch: 5.08 mm, connection method: Front screw connection, color: green, contact surface: Tin



## Double-level terminal block - UKK 3-MSTB-5,08 - 2770888

### Accessories

Printed-circuit board connector - FRONT-MSTB 2,5/15-ST-5,08 - 1777413

PCB connector, nominal current: 12 A, rated voltage (III/2): 320 V, nominal cross section: 2.5 mm<sup>2</sup>, number of positions: 15, pitch: 5.08 mm, connection method: Front screw connection, color: green, contact surface: Tin



Printed-circuit board connector - FRONT-MSTB 2,5/ 4-ST-5,08 - 1777303

PCB connector, nominal current: 12 A, rated voltage (III/2): 320 V, nominal cross section: 2.5 mm<sup>2</sup>, number of positions: 4, pitch: 5.08 mm, connection method: Front screw connection, color: green, contact surface: Tin



Printed-circuit board connector - FRONT-MSTB 2,5/ 5-ST-5,08 - 1777316

PCB connector, nominal current: 12 A, rated voltage (III/2): 320 V, nominal cross section: 2.5 mm<sup>2</sup>, number of positions: 5, pitch: 5.08 mm, connection method: Front screw connection, color: green, contact surface: Tin



Printed-circuit board connector - FRONT-MSTB 2,5/ 9-ST-5,08 - 1777358

PCB connector, nominal current: 12 A, rated voltage (III/2): 320 V, nominal cross section: 2.5 mm<sup>2</sup>, number of positions: 9, pitch: 5.08 mm, connection method: Front screw connection, color: green, contact surface: Tin



Printed-circuit board connector - FRONT-MSTB 2,5/12-ST-5,08 - 1777387

PCB connector, nominal current: 12 A, rated voltage (III/2): 320 V, nominal cross section: 2.5 mm<sup>2</sup>, number of positions: 12, pitch: 5.08 mm, connection method: Front screw connection, color: green, contact surface: Tin



## Double-level terminal block - UKK 3-MSTB-5,08 - 2770888

### Accessories

Printed-circuit board connector - FRONT-MSTB 2,5/18-ST-5,08 - 1777442

PCB connector, nominal current: 12 A, rated voltage (III/2): 320 V, nominal cross section: 2.5 mm<sup>2</sup>, number of positions: 18, pitch: 5.08 mm, connection method: Front screw connection, color: green, contact surface: Tin



Printed-circuit board connector - FRONT-MSTB 2,5/20-ST-5,08 - 1777468

PCB connector, nominal current: 12 A, rated voltage (III/2): 320 V, nominal cross section: 2.5 mm<sup>2</sup>, number of positions: 20, pitch: 5.08 mm, connection method: Front screw connection, color: green, contact surface: Tin



Printed-circuit board connector - FRONT-MSTB 2,5/23-ST-5,08 - 1777497

PCB connector, nominal current: 12 A, rated voltage (III/2): 320 V, nominal cross section: 2.5 mm<sup>2</sup>, number of positions: 23, pitch: 5.08 mm, connection method: Front screw connection, color: green, contact surface: Tin



Printed-circuit board connector - FRONT-MSTB 2,5/ 8-STF-5,08 - 1777798

PCB connector, nominal current: 12 A, rated voltage (III/2): 320 V, nominal cross section: 2.5 mm<sup>2</sup>, number of positions: 8, pitch: 5.08 mm, connection method: Front screw connection, color: green, contact surface: Tin



Printed-circuit board connector - FRONT-MSTB 2,5/ 5-STF-5,08 - 1777837

PCB connector, nominal current: 12 A, rated voltage (III/2): 320 V, nominal cross section: 2.5 mm<sup>2</sup>, number of positions: 5, pitch: 5.08 mm, connection method: Front screw connection, color: green, contact surface: Tin



## Double-level terminal block - UKK 3-MSTB-5,08 - 2770888

### Accessories

#### Printed-circuit board connector - FRONT-MSTB 2,5/ 6-STF-5,08 - 1777840

PCB connector, nominal current: 12 A, rated voltage (III/2): 320 V, nominal cross section: 2.5 mm<sup>2</sup>, number of positions: 6, pitch: 5.08 mm, connection method: Front screw connection, color: green, contact surface: Tin



#### Printed-circuit board connector - FRONT-MSTB 2,5/ 9-STF-5,08 - 1777866

PCB connector, nominal current: 12 A, rated voltage (III/2): 320 V, nominal cross section: 2.5 mm<sup>2</sup>, number of positions: 9, pitch: 5.08 mm, connection method: Front screw connection, color: green, contact surface: Tin



#### Printed-circuit board connector - FRONT-MSTB 2,5/11-STF-5,08 - 1777882

PCB connector, nominal current: 12 A, rated voltage (III/2): 320 V, nominal cross section: 2.5 mm<sup>2</sup>, number of positions: 11, pitch: 5.08 mm, connection method: Front screw connection, color: green, contact surface: Tin



#### Printed-circuit board connector - FRONT-MSTB 2,5/12-STF-5,08 - 1777895

PCB connector, nominal current: 12 A, rated voltage (III/2): 320 V, nominal cross section: 2.5 mm<sup>2</sup>, number of positions: 12, pitch: 5.08 mm, connection method: Front screw connection, color: green, contact surface: Tin



#### Printed-circuit board connector - FRONT-MSTB 2,5/13-STF-5,08 - 1777905

PCB connector, nominal current: 12 A, rated voltage (III/2): 320 V, nominal cross section: 2.5 mm<sup>2</sup>, number of positions: 13, pitch: 5.08 mm, connection method: Front screw connection, color: green, contact surface: Tin



## Double-level terminal block - UKK 3-MSTB-5,08 - 2770888

### Accessories

#### Printed-circuit board connector - FRONT-MSTB 2,5/16-STF-5,08 - 1777934

PCB connector, nominal current: 12 A, rated voltage (III/2): 320 V, nominal cross section: 2.5 mm<sup>2</sup>, number of positions: 16, pitch: 5.08 mm, connection method: Front screw connection, color: green, contact surface: Tin



---

#### Printed-circuit board connector - FRONT-MSTB 2,5/20-STF-5,08 - 1777976

PCB connector, nominal current: 12 A, rated voltage (III/2): 320 V, nominal cross section: 2.5 mm<sup>2</sup>, number of positions: 20, pitch: 5.08 mm, connection method: Front screw connection, color: green, contact surface: Tin



---

#### Printed-circuit board connector - FRONT-MSTB 2,5/ 3-STF-5,08 - 1777811

PCB connector, nominal current: 12 A, rated voltage (III/2): 320 V, nominal cross section: 2.5 mm<sup>2</sup>, number of positions: 3, pitch: 5.08 mm, connection method: Front screw connection, color: green, contact surface: Tin



---

#### Printed-circuit board connector - FRONT-MSTB 2,5/18-STF-5,08 - 1777950

PCB connector, nominal current: 12 A, rated voltage (III/2): 320 V, nominal cross section: 2.5 mm<sup>2</sup>, number of positions: 18, pitch: 5.08 mm, connection method: Front screw connection, color: green, contact surface: Tin



---

#### Printed-circuit board connector - FRONT-MSTB 2,5/ 7-STF-5,08 - 1777853

PCB connector, nominal current: 12 A, rated voltage (III/2): 320 V, nominal cross section: 2.5 mm<sup>2</sup>, number of positions: 7, pitch: 5.08 mm, connection method: Front screw connection, color: green, contact surface: Tin



## Double-level terminal block - UKK 3-MSTB-5,08 - 2770888

### Accessories

#### Printed-circuit board connector - FRONT-MSTB 2,5/19-STF-5,08 - 1777963

PCB connector, nominal current: 12 A, rated voltage (III/2): 320 V, nominal cross section: 2.5 mm<sup>2</sup>, number of positions: 19, pitch: 5.08 mm, connection method: Front screw connection, color: green, contact surface: Tin



#### Printed-circuit board connector - FRONT-MSTB 2,5/17-STF-5,08 - 1777947

PCB connector, nominal current: 12 A, rated voltage (III/2): 320 V, nominal cross section: 2.5 mm<sup>2</sup>, number of positions: 17, pitch: 5.08 mm, connection method: Front screw connection, color: green, contact surface: Tin



#### Printed-circuit board connector - FRONT-MSTB 2,5/14-STF-5,08 - 1777918

PCB connector, nominal current: 12 A, rated voltage (III/2): 320 V, nominal cross section: 2.5 mm<sup>2</sup>, number of positions: 14, pitch: 5.08 mm, connection method: Front screw connection, color: green, contact surface: Tin



#### Printed-circuit board connector - FRONT-MSTB 2,5/ 4-STF-5,08 - 1777824

PCB connector, nominal current: 12 A, rated voltage (III/2): 320 V, nominal cross section: 2.5 mm<sup>2</sup>, number of positions: 4, pitch: 5.08 mm, connection method: Front screw connection, color: green, contact surface: Tin



#### Printed-circuit board connector - FRONT-MSTB 2,5/10-STF-5,08 - 1777879

PCB connector, nominal current: 12 A, rated voltage (III/2): 320 V, nominal cross section: 2.5 mm<sup>2</sup>, number of positions: 10, pitch: 5.08 mm, connection method: Front screw connection, color: green, contact surface: Tin



## Double-level terminal block - UKK 3-MSTB-5,08 - 2770888

### Accessories

Printed-circuit board connector - FRONT-MSTB 2,5/15-STF-5,08 - 1777921

PCB connector, nominal current: 12 A, rated voltage (III/2): 320 V, nominal cross section: 2.5 mm<sup>2</sup>, number of positions: 15, pitch: 5.08 mm, connection method: Front screw connection, color: green, contact surface: Tin



Printed-circuit board connector - FRONT-MSTB 2,5/ 2-STF-5,08 - 1777808

PCB connector, nominal current: 12 A, rated voltage (III/2): 320 V, nominal cross section: 2.5 mm<sup>2</sup>, number of positions: 2, pitch: 5.08 mm, connection method: Front screw connection, color: green, contact surface: Tin



Printed-circuit board connector - FKC 2,5/ 4-ST-5,08 - 1873074

PCB connector, nominal current: 12 A, rated voltage (III/2): 320 V, nominal cross section: 2.5 mm<sup>2</sup>, number of positions: 4, pitch: 5.08 mm, connection method: Push-in spring connection, color: green, contact surface: Tin



Printed-circuit board connector - FKC 2,5/ 5-ST-5,08 - 1873087

PCB connector, nominal current: 12 A, rated voltage (III/2): 320 V, nominal cross section: 2.5 mm<sup>2</sup>, number of positions: 5, pitch: 5.08 mm, connection method: Push-in spring connection, color: green, contact surface: Tin



Printed-circuit board connector - FKC 2,5/ 7-ST-5,08 - 1873100

PCB connector, nominal current: 12 A, rated voltage (III/2): 320 V, nominal cross section: 2.5 mm<sup>2</sup>, number of positions: 7, pitch: 5.08 mm, connection method: Push-in spring connection, color: green, contact surface: Tin



## Double-level terminal block - UKK 3-MSTB-5,08 - 2770888

### Accessories

#### Printed-circuit board connector - FKC 2,5/ 8-ST-5,08 - 1873113

PCB connector, nominal current: 12 A, rated voltage (III/2): 320 V, nominal cross section: 2.5 mm<sup>2</sup>, number of positions: 8, pitch: 5.08 mm, connection method: Push-in spring connection, color: green, contact surface: Tin



---

#### Printed-circuit board connector - FKC 2,5/10-ST-5,08 - 1873139

PCB connector, nominal current: 12 A, rated voltage (III/2): 320 V, nominal cross section: 2.5 mm<sup>2</sup>, number of positions: 10, pitch: 5.08 mm, connection method: Push-in spring connection, color: green, contact surface: Tin



---

#### Printed-circuit board connector - FKC 2,5/12-ST-5,08 - 1873155

PCB connector, nominal current: 12 A, rated voltage (III/2): 320 V, nominal cross section: 2.5 mm<sup>2</sup>, number of positions: 12, pitch: 5.08 mm, connection method: Push-in spring connection, color: green, contact surface: Tin



---

#### Printed-circuit board connector - FKC 2,5/13-ST-5,08 - 1873168

PCB connector, nominal current: 12 A, rated voltage (III/2): 320 V, nominal cross section: 2.5 mm<sup>2</sup>, number of positions: 13, pitch: 5.08 mm, connection method: Push-in spring connection, color: green, contact surface: Tin



---

#### Printed-circuit board connector - FKC 2,5/16-ST-5,08 - 1873197

PCB connector, nominal current: 12 A, rated voltage (III/2): 320 V, nominal cross section: 2.5 mm<sup>2</sup>, number of positions: 16, pitch: 5.08 mm, connection method: Push-in spring connection, color: green, contact surface: Tin





## Double-level terminal block - UKK 3-MSTB-5,08 - 2770888

### Accessories

#### Printed-circuit board connector - FKC 2,5/ 3-ST-5,08 - 1873061

PCB connector, nominal current: 12 A, rated voltage (III/2): 320 V, nominal cross section: 2.5 mm<sup>2</sup>, number of positions: 3, pitch: 5.08 mm, connection method: Push-in spring connection, color: green, contact surface: Tin



#### Printed-circuit board connector - FKC 2,5/ 9-ST-5,08 - 1873126

PCB connector, nominal current: 12 A, rated voltage (III/2): 320 V, nominal cross section: 2.5 mm<sup>2</sup>, number of positions: 9, pitch: 5.08 mm, connection method: Push-in spring connection, color: green, contact surface: Tin



#### Printed-circuit board connector - FKC 2,5/14-ST-5,08 - 1873171

PCB connector, nominal current: 12 A, rated voltage (III/2): 320 V, nominal cross section: 2.5 mm<sup>2</sup>, number of positions: 14, pitch: 5.08 mm, connection method: Push-in spring connection, color: green, contact surface: Tin



#### Printed-circuit board connector - FKC 2,5/ 6-ST-5,08 - 1873090

PCB connector, nominal current: 12 A, rated voltage (III/2): 320 V, nominal cross section: 2.5 mm<sup>2</sup>, number of positions: 6, pitch: 5.08 mm, connection method: Push-in spring connection, color: green, contact surface: Tin



#### Printed-circuit board connector - FKC 2,5/11-ST-5,08 - 1873142

PCB connector, nominal current: 12 A, rated voltage (III/2): 320 V, nominal cross section: 2.5 mm<sup>2</sup>, number of positions: 11, pitch: 5.08 mm, connection method: Push-in spring connection, color: green, contact surface: Tin



## Double-level terminal block - UKK 3-MSTB-5,08 - 2770888

### Accessories

Printed-circuit board connector - FKC 2,5/15-ST-5,08 - 1873184

PCB connector, nominal current: 12 A, rated voltage (III/2): 320 V, nominal cross section: 2.5 mm<sup>2</sup>, number of positions: 15, pitch: 5.08 mm, connection method: Push-in spring connection, color: green, contact surface: Tin



Printed-circuit board connector - FKC 2,5/ 2-ST-5,08 - 1873058

PCB connector, nominal current: 12 A, rated voltage (III/2): 320 V, nominal cross section: 2.5 mm<sup>2</sup>, number of positions: 2, pitch: 5.08 mm, connection method: Push-in spring connection, color: green, contact surface: Tin



Printed-circuit board connector - QC 1/ 2-ST-5,08 - 1883255

PCB connector, nominal current: 10 A, rated voltage (III/2): 630 V, nominal cross section: 1 mm<sup>2</sup>, number of positions: 2, pitch: 5.08 mm, connection method: Displacement connection, color: green, contact surface: Tin



Printed-circuit board connector - QC 1/ 5-ST-5,08 - 1883284

PCB connector, nominal current: 10 A, rated voltage (III/2): 630 V, nominal cross section: 1 mm<sup>2</sup>, number of positions: 5, pitch: 5.08 mm, connection method: Displacement connection, color: green, contact surface: Tin



Printed-circuit board connector - QC 1/ 6-ST-5,08 - 1883297

PCB connector, nominal current: 10 A, rated voltage (III/2): 630 V, nominal cross section: 1 mm<sup>2</sup>, number of positions: 6, pitch: 5.08 mm, connection method: Displacement connection, color: green, contact surface: Tin



## Double-level terminal block - UKK 3-MSTB-5,08 - 2770888

### Accessories

Printed-circuit board connector - QC 1/ 8-ST-5,08 - 1883310



PCB connector, nominal current: 10 A, rated voltage (III/2): 630 V, nominal cross section: 1 mm<sup>2</sup>, number of positions: 8, pitch: 5.08 mm, connection method: Displacement connection, color: green, contact surface: Tin

Printed-circuit board connector - QC 1/12-ST-5,08 - 1883705



PCB connector, nominal current: 10 A, rated voltage (III/2): 630 V, nominal cross section: 1 mm<sup>2</sup>, number of positions: 12, pitch: 5.08 mm, connection method: Displacement connection, color: green, contact surface: Tin

Printed-circuit board connector - QC 1/15-ST-5,08 - 1883831



PCB connector, nominal current: 10 A, rated voltage (III/2): 630 V, nominal cross section: 1 mm<sup>2</sup>, number of positions: 15, pitch: 5.08 mm, connection method: Displacement connection, color: green, contact surface: Tin

Printed-circuit board connector - QC 1/16-ST-5,08 - 1883844



PCB connector, nominal current: 10 A, rated voltage (III/2): 630 V, nominal cross section: 1 mm<sup>2</sup>, number of positions: 16, pitch: 5.08 mm, connection method: Displacement connection, color: green, contact surface: Tin

Printed-circuit board connector - QC 1/13-ST-5,08 - 1883815



PCB connector, nominal current: 10 A, rated voltage (III/2): 630 V, nominal cross section: 1 mm<sup>2</sup>, number of positions: 13, pitch: 5.08 mm, connection method: Displacement connection, color: green, contact surface: Tin

## Double-level terminal block - UKK 3-MSTB-5,08 - 2770888

### Accessories

Printed-circuit board connector - QC 1/10-ST-5,08 - 1883336



PCB connector, nominal current: 10 A, rated voltage (III/2): 630 V, nominal cross section: 1 mm<sup>2</sup>, number of positions: 10, pitch: 5.08 mm, connection method: Displacement connection, color: green, contact surface: Tin

Printed-circuit board connector - QC 1/14-ST-5,08 - 1883828



PCB connector, nominal current: 10 A, rated voltage (III/2): 630 V, nominal cross section: 1 mm<sup>2</sup>, number of positions: 14, pitch: 5.08 mm, connection method: Displacement connection, color: green, contact surface: Tin

Printed-circuit board connector - QC 1/ 9-ST-5,08 - 1883323



PCB connector, nominal current: 10 A, rated voltage (III/2): 630 V, nominal cross section: 1 mm<sup>2</sup>, number of positions: 9, pitch: 5.08 mm, connection method: Displacement connection, color: green, contact surface: Tin

Printed-circuit board connector - QC 1/11-ST-5,08 - 1883349



PCB connector, nominal current: 10 A, rated voltage (III/2): 630 V, nominal cross section: 1 mm<sup>2</sup>, number of positions: 11, pitch: 5.08 mm, connection method: Displacement connection, color: green, contact surface: Tin

Printed-circuit board connector - QC 1/ 7-ST-5,08 - 1883307



PCB connector, nominal current: 10 A, rated voltage (III/2): 630 V, nominal cross section: 1 mm<sup>2</sup>, number of positions: 7, pitch: 5.08 mm, connection method: Displacement connection, color: green, contact surface: Tin

## Double-level terminal block - UKK 3-MSTB-5,08 - 2770888

### Accessories

#### Printed-circuit board connector - QC 1/ 4-ST-5,08 - 1883271



PCB connector, nominal current: 10 A, rated voltage (III/2): 630 V, nominal cross section: 1 mm<sup>2</sup>, number of positions: 4, pitch: 5.08 mm, connection method: Displacement connection, color: green, contact surface: Tin

#### Printed-circuit board connector - QC 1/ 3-ST-5,08 - 1883268



PCB connector, nominal current: 10 A, rated voltage (III/2): 630 V, nominal cross section: 1 mm<sup>2</sup>, number of positions: 3, pitch: 5.08 mm, connection method: Displacement connection, color: green, contact surface: Tin

#### Printed-circuit board connector - MSTBC 2,5/ 5-ST-5,08 - 1808845



PCB connector, nominal current: 12 A, rated voltage (III/2): 320 V, nominal cross section: 2.5 mm<sup>2</sup>, number of positions: 5, pitch: 5.08 mm, connection method: Crimp connection, color: green, Corresponding female crimp contacts with current [A] and conductor cross section range [mm<sup>2</sup>] data: 10A/MSTBC-MT 0,5-1,0 (3190564); 10A/MSTBC-MT 0,5-1,0 BA (3190645); 12A/MSTBC-MT 1,5-2,5 (3190551); 12A/MSTBC-MT 1,5-2,5 BA (3190658). BA = Bandkontakte

#### Printed-circuit board connector - MSTBC 2,5/ 6-ST-5,08 - 1808858



PCB connector, nominal current: 12 A, rated voltage (III/2): 320 V, nominal cross section: 2.5 mm<sup>2</sup>, number of positions: 6, pitch: 5.08 mm, connection method: Crimp connection, color: green, Corresponding female crimp contacts with current [A] and conductor cross section range [mm<sup>2</sup>] data: 10A/MSTBC-MT 0,5-1,0 (3190564); 10A/MSTBC-MT 0,5-1,0 BA (3190645); 12A/MSTBC-MT 1,5-2,5 (3190551); 12A/MSTBC-MT 1,5-2,5 BA (3190658). BA = Bandkontakte

#### Printed-circuit board connector - MSTBC 2,5/ 8-ST-5,08 - 1808874



PCB connector, nominal current: 12 A, rated voltage (III/2): 320 V, nominal cross section: 2.5 mm<sup>2</sup>, number of positions: 8, pitch: 5.08 mm, connection method: Crimp connection, color: green, Corresponding female crimp contacts with current [A] and conductor cross section range [mm<sup>2</sup>] data: 10A/MSTBC-MT 0,5-1,0 (3190564); 10A/MSTBC-MT 0,5-1,0 BA (3190645); 12A/MSTBC-MT 1,5-2,5 (3190551); 12A/MSTBC-MT 1,5-2,5 BA (3190658). BA = Bandkontakte

## Double-level terminal block - UKK 3-MSTB-5,08 - 2770888

### Accessories

#### Printed-circuit board connector - MSTBC 2,5/13-ST-5,08 - 1808926

PCB connector, nominal current: 12 A, rated voltage (III/2): 320 V, nominal cross section: 2.5 mm<sup>2</sup>, number of positions: 13, pitch: 5.08 mm, connection method: Crimp connection, color: green, Corresponding female crimp contacts with current [A] and conductor cross section range [mm<sup>2</sup>] data: 10A/MSTBC-MT 0,5-1,0 (3190564); 10A/MSTBC-MT 0,5-1,0 BA (3190645); 12A/MSTBC-MT 1,5-2,5 (3190551); 12A/MSTBC-MT 1,5-2,5 BA (3190658). BA = Bandkontakte



#### Printed-circuit board connector - MSTBC 2,5/14-ST-5,08 - 1808939

PCB connector, nominal current: 12 A, rated voltage (III/2): 320 V, nominal cross section: 2.5 mm<sup>2</sup>, number of positions: 14, pitch: 5.08 mm, connection method: Crimp connection, color: green, Corresponding female crimp contacts with current [A] and conductor cross section range [mm<sup>2</sup>] data: 10A/MSTBC-MT 0,5-1,0 (3190564); 10A/MSTBC-MT 0,5-1,0 BA (3190645); 12A/MSTBC-MT 1,5-2,5 (3190551); 12A/MSTBC-MT 1,5-2,5 BA (3190658). BA = Bandkontakte



#### Printed-circuit board connector - MSTBC 2,5/15-ST-5,08 - 1808942

PCB connector, nominal current: 12 A, rated voltage (III/2): 320 V, nominal cross section: 2.5 mm<sup>2</sup>, number of positions: 15, pitch: 5.08 mm, connection method: Crimp connection, color: green, Corresponding female crimp contacts with current [A] and conductor cross section range [mm<sup>2</sup>] data: 10A/MSTBC-MT 0,5-1,0 (3190564); 10A/MSTBC-MT 0,5-1,0 BA (3190645); 12A/MSTBC-MT 1,5-2,5 (3190551); 12A/MSTBC-MT 1,5-2,5 BA (3190658). BA = Bandkontakte



#### Printed-circuit board connector - MSTBC 2,5/19-ST-5,08 - 1808984

PCB connector, nominal current: 12 A, rated voltage (III/2): 320 V, nominal cross section: 2.5 mm<sup>2</sup>, number of positions: 19, pitch: 5.08 mm, connection method: Crimp connection, color: green, Corresponding female crimp contacts with current [A] and conductor cross section range [mm<sup>2</sup>] data: 10A/MSTBC-MT 0,5-1,0 (3190564); 10A/MSTBC-MT 0,5-1,0 BA (3190645); 12A/MSTBC-MT 1,5-2,5 (3190551); 12A/MSTBC-MT 1,5-2,5 BA (3190658). BA = Bandkontakte



#### Printed-circuit board connector - MSTBC 2,5/20-ST-5,08 - 1808997

PCB connector, nominal current: 12 A, rated voltage (III/2): 320 V, nominal cross section: 2.5 mm<sup>2</sup>, number of positions: 20, pitch: 5.08 mm, connection method: Crimp connection, color: green, Corresponding female crimp contacts with current [A] and conductor cross section range [mm<sup>2</sup>] data: 10A/MSTBC-MT 0,5-1,0 (3190564); 10A/MSTBC-MT 0,5-1,0 BA (3190645); 12A/MSTBC-MT 1,5-2,5 (3190551); 12A/MSTBC-MT 1,5-2,5 BA (3190658). BA = Bandkontakte



## Double-level terminal block - UKK 3-MSTB-5,08 - 2770888

### Accessories

#### Printed-circuit board connector - MSTBC 2,5/12-ST-5,08 - 1808913

PCB connector, nominal current: 12 A, rated voltage (III/2): 320 V, nominal cross section: 2.5 mm<sup>2</sup>, number of positions: 12, pitch: 5.08 mm, connection method: Crimp connection, color: green, Corresponding female crimp contacts with current [A] and conductor cross section range [mm<sup>2</sup>] data: 10A/MSTBC-MT 0,5-1,0 (3190564); 10A/MSTBC-MT 0,5-1,0 BA (3190645); 12A/MSTBC-MT 1,5-2,5 (3190551); 12A/MSTBC-MT 1,5-2,5 BA (3190658). BA = Bandkontakte



#### Printed-circuit board connector - MSTBC 2,5/18-ST-5,08 - 1808971

PCB connector, nominal current: 12 A, rated voltage (III/2): 320 V, nominal cross section: 2.5 mm<sup>2</sup>, number of positions: 18, pitch: 5.08 mm, connection method: Crimp connection, color: green, Corresponding female crimp contacts with current [A] and conductor cross section range [mm<sup>2</sup>] data: 10A/MSTBC-MT 0,5-1,0 (3190564); 10A/MSTBC-MT 0,5-1,0 BA (3190645); 12A/MSTBC-MT 1,5-2,5 (3190551); 12A/MSTBC-MT 1,5-2,5 BA (3190658). BA = Bandkontakte



#### Printed-circuit board connector - MSTBC 2,5/ 3-ST-5,08 - 1808829

PCB connector, nominal current: 12 A, rated voltage (III/2): 320 V, nominal cross section: 2.5 mm<sup>2</sup>, number of positions: 3, pitch: 5.08 mm, connection method: Crimp connection, color: green, Corresponding female crimp contacts with current [A] and conductor cross section range [mm<sup>2</sup>] data: 10A/MSTBC-MT 0,5-1,0 (3190564); 10A/MSTBC-MT 0,5-1,0 BA (3190645); 12A/MSTBC-MT 1,5-2,5 (3190551); 12A/MSTBC-MT 1,5-2,5 BA (3190658). BA = Bandkontakte



#### Printed-circuit board connector - MSTBC 2,5/22-ST-5,08 - 1809019

PCB connector, nominal current: 12 A, rated voltage (III/2): 320 V, nominal cross section: 2.5 mm<sup>2</sup>, number of positions: 22, pitch: 5.08 mm, connection method: Crimp connection, color: green, Corresponding female crimp contacts with current [A] and conductor cross section range [mm<sup>2</sup>] data: 10A/MSTBC-MT 0,5-1,0 (3190564); 10A/MSTBC-MT 0,5-1,0 BA (3190645); 12A/MSTBC-MT 1,5-2,5 (3190551); 12A/MSTBC-MT 1,5-2,5 BA (3190658). BA = Bandkontakte



#### Printed-circuit board connector - MSTBC 2,5/ 7-ST-5,08 - 1808861

PCB connector, nominal current: 12 A, rated voltage (III/2): 320 V, nominal cross section: 2.5 mm<sup>2</sup>, number of positions: 7, pitch: 5.08 mm, connection method: Crimp connection, color: green, Corresponding female crimp contacts with current [A] and conductor cross section range [mm<sup>2</sup>] data: 10A/MSTBC-MT 0,5-1,0 (3190564); 10A/MSTBC-MT 0,5-1,0 BA (3190645); 12A/MSTBC-MT 1,5-2,5 (3190551); 12A/MSTBC-MT 1,5-2,5 BA (3190658). BA = Bandkontakte



## Double-level terminal block - UKK 3-MSTB-5,08 - 2770888

### Accessories

#### Printed-circuit board connector - MSTBC 2,5/ 9-ST-5,08 - 1808887

PCB connector, nominal current: 12 A, rated voltage (III/2): 320 V, nominal cross section: 2.5 mm<sup>2</sup>, number of positions: 9, pitch: 5.08 mm, connection method: Crimp connection, color: green, Corresponding female crimp contacts with current [A] and conductor cross section range [mm<sup>2</sup>] data: 10A/MSTBC-MT 0,5-1,0 (3190564); 10A/MSTBC-MT 0,5-1,0 BA (3190645); 12A/MSTBC-MT 1,5-2,5 (3190551); 12A/MSTBC-MT 1,5-2,5 BA (3190658). BA = Bandkontakte



#### Printed-circuit board connector - MSTBC 2,5/23-ST-5,08 - 1809022

PCB connector, nominal current: 12 A, rated voltage (III/2): 320 V, nominal cross section: 2.5 mm<sup>2</sup>, number of positions: 23, pitch: 5.08 mm, connection method: Crimp connection, color: green, Corresponding female crimp contacts with current [A] and conductor cross section range [mm<sup>2</sup>] data: 10A/MSTBC-MT 0,5-1,0 (3190564); 10A/MSTBC-MT 0,5-1,0 BA (3190645); 12A/MSTBC-MT 1,5-2,5 (3190551); 12A/MSTBC-MT 1,5-2,5 BA (3190658). BA = Bandkontakte



#### Printed-circuit board connector - MSTBC 2,5/10-ST-5,08 - 1808890

PCB connector, nominal current: 12 A, rated voltage (III/2): 320 V, nominal cross section: 2.5 mm<sup>2</sup>, number of positions: 10, pitch: 5.08 mm, connection method: Crimp connection, color: green, Corresponding female crimp contacts with current [A] and conductor cross section range [mm<sup>2</sup>] data: 10A/MSTBC-MT 0,5-1,0 (3190564); 10A/MSTBC-MT 0,5-1,0 BA (3190645); 12A/MSTBC-MT 1,5-2,5 (3190551); 12A/MSTBC-MT 1,5-2,5 BA (3190658). BA = Bandkontakte



#### Printed-circuit board connector - MSTBC 2,5/ 2-ST-5,08 - 1808816

PCB connector, nominal current: 12 A, rated voltage (III/2): 320 V, nominal cross section: 2.5 mm<sup>2</sup>, number of positions: 2, pitch: 5.08 mm, connection method: Crimp connection, color: green, Corresponding female crimp contacts with current [A] and conductor cross section range [mm<sup>2</sup>] data: 10A/MSTBC-MT 0,5-1,0 (3190564); 10A/MSTBC-MT 0,5-1,0 BA (3190645); 12A/MSTBC-MT 1,5-2,5 (3190551); 12A/MSTBC-MT 1,5-2,5 BA (3190658). BA = Bandkontakte



#### Printed-circuit board connector - MSTBC 2,5/ 4-ST-5,08 - 1808832

PCB connector, nominal current: 12 A, rated voltage (III/2): 320 V, nominal cross section: 2.5 mm<sup>2</sup>, number of positions: 4, pitch: 5.08 mm, connection method: Crimp connection, color: green, Corresponding female crimp contacts with current [A] and conductor cross section range [mm<sup>2</sup>] data: 10A/MSTBC-MT 0,5-1,0 (3190564); 10A/MSTBC-MT 0,5-1,0 BA (3190645); 12A/MSTBC-MT 1,5-2,5 (3190551); 12A/MSTBC-MT 1,5-2,5 BA (3190658). BA = Bandkontakte





## Double-level terminal block - UKK 3-MSTB-5,08 - 2770888

### Accessories

#### Printed-circuit board connector - MSTBC 2,5/11-ST-5,08 - 1808900

PCB connector, nominal current: 12 A, rated voltage (III/2): 320 V, nominal cross section: 2.5 mm<sup>2</sup>, number of positions: 11, pitch: 5.08 mm, connection method: Crimp connection, color: green, Corresponding female crimp contacts with current [A] and conductor cross section range [mm<sup>2</sup>] data: 10A/MSTBC-MT 0,5-1,0 (3190564); 10A/MSTBC-MT 0,5-1,0 BA (3190645); 12A/MSTBC-MT 1,5-2,5 (3190551); 12A/MSTBC-MT 1,5-2,5 BA (3190658). BA = Bandkontakte



#### Printed-circuit board connector - MSTBC 2,5/16-ST-5,08 - 1808955

PCB connector, nominal current: 12 A, rated voltage (III/2): 320 V, nominal cross section: 2.5 mm<sup>2</sup>, number of positions: 16, pitch: 5.08 mm, connection method: Crimp connection, color: green, Corresponding female crimp contacts with current [A] and conductor cross section range [mm<sup>2</sup>] data: 10A/MSTBC-MT 0,5-1,0 (3190564); 10A/MSTBC-MT 0,5-1,0 BA (3190645); 12A/MSTBC-MT 1,5-2,5 (3190551); 12A/MSTBC-MT 1,5-2,5 BA (3190658). BA = Bandkontakte



#### Printed-circuit board connector - MSTBC 2,5/17-ST-5,08 - 1808968

PCB connector, nominal current: 12 A, rated voltage (III/2): 320 V, nominal cross section: 2.5 mm<sup>2</sup>, number of positions: 17, pitch: 5.08 mm, connection method: Crimp connection, color: green, Corresponding female crimp contacts with current [A] and conductor cross section range [mm<sup>2</sup>] data: 10A/MSTBC-MT 0,5-1,0 (3190564); 10A/MSTBC-MT 0,5-1,0 BA (3190645); 12A/MSTBC-MT 1,5-2,5 (3190551); 12A/MSTBC-MT 1,5-2,5 BA (3190658). BA = Bandkontakte



#### Printed-circuit board connector - MSTBC 2,5/24-ST-5,08 - 1809035

PCB connector, nominal current: 12 A, rated voltage (III/2): 320 V, nominal cross section: 2.5 mm<sup>2</sup>, number of positions: 24, pitch: 5.08 mm, connection method: Crimp connection, color: green, Corresponding female crimp contacts with current [A] and conductor cross section range [mm<sup>2</sup>] data: 10A/MSTBC-MT 0,5-1,0 (3190564); 10A/MSTBC-MT 0,5-1,0 BA (3190645); 12A/MSTBC-MT 1,5-2,5 (3190551); 12A/MSTBC-MT 1,5-2,5 BA (3190658). BA = Bandkontakte



#### Printed-circuit board connector - MSTBC 2,5/21-ST-5,08 - 1809006

PCB connector, nominal current: 12 A, rated voltage (III/2): 320 V, nominal cross section: 2.5 mm<sup>2</sup>, number of positions: 21, pitch: 5.08 mm, connection method: Crimp connection, color: green, Corresponding female crimp contacts with current [A] and conductor cross section range [mm<sup>2</sup>] data: 10A/MSTBC-MT 0,5-1,0 (3190564); 10A/MSTBC-MT 0,5-1,0 BA (3190645); 12A/MSTBC-MT 1,5-2,5 (3190551); 12A/MSTBC-MT 1,5-2,5 BA (3190658). BA = Bandkontakte



## Double-level terminal block - UKK 3-MSTB-5,08 - 2770888

### Accessories

#### Printed-circuit board connector - MSTBC 2,5/ 2-STZ-5,08 - 1809501

PCB connector, nominal current: 12 A, rated voltage (III/2): 320 V, nominal cross section: 2.5 mm<sup>2</sup>, number of positions: 2, pitch: 5.08 mm, connection method: Crimp connection, color: green, Corresponding female crimp contacts with current [A] and conductor cross section range [mm<sup>2</sup>] data: 10A/MSTBC-MT 0,5-1,0 (3190564); 10A/MSTBC-MT 0,5-1,0 BA (3190645); 12A/MSTBC-MT 1,5-2,5 (3190551); 12A/MSTBC-MT 1,5-2,5 BA (3190658). BA = Bandkontakte



#### Printed-circuit board connector - MSTBC 2,5/ 5-STZ-5,08 - 1809530

PCB connector, nominal current: 12 A, rated voltage (III/2): 320 V, nominal cross section: 2.5 mm<sup>2</sup>, number of positions: 5, pitch: 5.08 mm, connection method: Crimp connection, color: green, Corresponding female crimp contacts with current [A] and conductor cross section range [mm<sup>2</sup>] data: 10A/MSTBC-MT 0,5-1,0 (3190564); 10A/MSTBC-MT 0,5-1,0 BA (3190645); 12A/MSTBC-MT 1,5-2,5 (3190551); 12A/MSTBC-MT 1,5-2,5 BA (3190658). BA = Bandkontakte



#### Printed-circuit board connector - MSTBC 2,5/ 6-STZ-5,08 - 1809543

PCB connector, nominal current: 12 A, rated voltage (III/2): 320 V, nominal cross section: 2.5 mm<sup>2</sup>, number of positions: 6, pitch: 5.08 mm, connection method: Crimp connection, color: green, Corresponding female crimp contacts with current [A] and conductor cross section range [mm<sup>2</sup>] data: 10A/MSTBC-MT 0,5-1,0 (3190564); 10A/MSTBC-MT 0,5-1,0 BA (3190645); 12A/MSTBC-MT 1,5-2,5 (3190551); 12A/MSTBC-MT 1,5-2,5 BA (3190658). BA = Bandkontakte



#### Printed-circuit board connector - MSTBC 2,5/ 9-STZ-5,08 - 1809572

PCB connector, nominal current: 12 A, rated voltage (III/2): 320 V, nominal cross section: 2.5 mm<sup>2</sup>, number of positions: 9, pitch: 5.08 mm, connection method: Crimp connection, color: green, Corresponding female crimp contacts with current [A] and conductor cross section range [mm<sup>2</sup>] data: 10A/MSTBC-MT 0,5-1,0 (3190564); 10A/MSTBC-MT 0,5-1,0 BA (3190645); 12A/MSTBC-MT 1,5-2,5 (3190551); 12A/MSTBC-MT 1,5-2,5 BA (3190658). BA = Bandkontakte



#### Printed-circuit board connector - MSTBC 2,5/13-STZ-5,08 - 1809611

PCB connector, nominal current: 12 A, rated voltage (III/2): 320 V, nominal cross section: 2.5 mm<sup>2</sup>, number of positions: 13, pitch: 5.08 mm, connection method: Crimp connection, color: green, Corresponding female crimp contacts with current [A] and conductor cross section range [mm<sup>2</sup>] data: 10A/MSTBC-MT 0,5-1,0 (3190564); 10A/MSTBC-MT 0,5-1,0 BA (3190645); 12A/MSTBC-MT 1,5-2,5 (3190551); 12A/MSTBC-MT 1,5-2,5 BA (3190658). BA = Bandkontakte



## Double-level terminal block - UKK 3-MSTB-5,08 - 2770888

### Accessories

#### Printed-circuit board connector - MSTBC 2,5/15-STZ-5,08 - 1809637

PCB connector, nominal current: 12 A, rated voltage (III/2): 320 V, nominal cross section: 2.5 mm<sup>2</sup>, number of positions: 15, pitch: 5.08 mm, connection method: Crimp connection, color: green, Corresponding female crimp contacts with current [A] and conductor cross section range [mm<sup>2</sup>] data: 10A/MSTBC-MT 0,5-1,0 (3190564); 10A/MSTBC-MT 0,5-1,0 BA (3190645); 12A/MSTBC-MT 1,5-2,5 (3190551); 12A/MSTBC-MT 1,5-2,5 BA (3190658). BA = Bandkontakte



#### Printed-circuit board connector - MSTBC 2,5/16-STZ-5,08 - 1809640

PCB connector, nominal current: 12 A, rated voltage (III/2): 320 V, nominal cross section: 2.5 mm<sup>2</sup>, number of positions: 16, pitch: 5.08 mm, connection method: Crimp connection, color: green, Corresponding female crimp contacts with current [A] and conductor cross section range [mm<sup>2</sup>] data: 10A/MSTBC-MT 0,5-1,0 (3190564); 10A/MSTBC-MT 0,5-1,0 BA (3190645); 12A/MSTBC-MT 1,5-2,5 (3190551); 12A/MSTBC-MT 1,5-2,5 BA (3190658). BA = Bandkontakte



#### Printed-circuit board connector - MSTBC 2,5/19-STZ-5,08 - 1809679

PCB connector, nominal current: 12 A, rated voltage (III/2): 320 V, nominal cross section: 2.5 mm<sup>2</sup>, number of positions: 19, pitch: 5.08 mm, connection method: Crimp connection, color: green, Corresponding female crimp contacts with current [A] and conductor cross section range [mm<sup>2</sup>] data: 10A/MSTBC-MT 0,5-1,0 (3190564); 10A/MSTBC-MT 0,5-1,0 BA (3190645); 12A/MSTBC-MT 1,5-2,5 (3190551); 12A/MSTBC-MT 1,5-2,5 BA (3190658). BA = Bandkontakte



#### Printed-circuit board connector - MSTBC 2,5/21-STZ-5,08 - 1809695

PCB connector, nominal current: 12 A, rated voltage (III/2): 320 V, nominal cross section: 2.5 mm<sup>2</sup>, number of positions: 21, pitch: 5.08 mm, connection method: Crimp connection, color: green, Corresponding female crimp contacts with current [A] and conductor cross section range [mm<sup>2</sup>] data: 10A/MSTBC-MT 0,5-1,0 (3190564); 10A/MSTBC-MT 0,5-1,0 BA (3190645); 12A/MSTBC-MT 1,5-2,5 (3190551); 12A/MSTBC-MT 1,5-2,5 BA (3190658). BA = Bandkontakte



#### Printed-circuit board connector - MSTBC 2,5/22-STZ-5,08 - 1809705

PCB connector, nominal current: 12 A, rated voltage (III/2): 320 V, nominal cross section: 2.5 mm<sup>2</sup>, number of positions: 22, pitch: 5.08 mm, connection method: Crimp connection, color: green, Corresponding female crimp contacts with current [A] and conductor cross section range [mm<sup>2</sup>] data: 10A/MSTBC-MT 0,5-1,0 (3190564); 10A/MSTBC-MT 0,5-1,0 BA (3190645); 12A/MSTBC-MT 1,5-2,5 (3190551); 12A/MSTBC-MT 1,5-2,5 BA (3190658). BA = Bandkontakte



## Double-level terminal block - UKK 3-MSTB-5,08 - 2770888

### Accessories

#### Printed-circuit board connector - MSTBC 2,5/24-STZ-5,08 - 1809721

PCB connector, nominal current: 12 A, rated voltage (III/2): 320 V, nominal cross section: 2.5 mm<sup>2</sup>, number of positions: 24, pitch: 5.08 mm, connection method: Crimp connection, color: green, Corresponding female crimp contacts with current [A] and conductor cross section range [mm<sup>2</sup>] data: 10A/MSTBC-MT 0,5-1,0 (3190564); 10A/MSTBC-MT 0,5-1,0 BA (3190645); 12A/MSTBC-MT 1,5-2,5 (3190551); 12A/MSTBC-MT 1,5-2,5 BA (3190658). BA = Bandkontakte



#### Printed-circuit board connector - MSTBC 2,5/14-STZ-5,08 - 1809624

PCB connector, nominal current: 12 A, rated voltage (III/2): 320 V, nominal cross section: 2.5 mm<sup>2</sup>, number of positions: 14, pitch: 5.08 mm, connection method: Crimp connection, color: green, Corresponding female crimp contacts with current [A] and conductor cross section range [mm<sup>2</sup>] data: 10A/MSTBC-MT 0,5-1,0 (3190564); 10A/MSTBC-MT 0,5-1,0 BA (3190645); 12A/MSTBC-MT 1,5-2,5 (3190551); 12A/MSTBC-MT 1,5-2,5 BA (3190658). BA = Bandkontakte



#### Printed-circuit board connector - MSTBC 2,5/20-STZ-5,08 - 1809682

PCB connector, nominal current: 12 A, rated voltage (III/2): 320 V, nominal cross section: 2.5 mm<sup>2</sup>, number of positions: 20, pitch: 5.08 mm, connection method: Crimp connection, color: green, Corresponding female crimp contacts with current [A] and conductor cross section range [mm<sup>2</sup>] data: 10A/MSTBC-MT 0,5-1,0 (3190564); 10A/MSTBC-MT 0,5-1,0 BA (3190645); 12A/MSTBC-MT 1,5-2,5 (3190551); 12A/MSTBC-MT 1,5-2,5 BA (3190658). BA = Bandkontakte



#### Printed-circuit board connector - MSTBC 2,5/12-STZ-5,08 - 1809608

PCB connector, nominal current: 12 A, rated voltage (III/2): 320 V, nominal cross section: 2.5 mm<sup>2</sup>, number of positions: 12, pitch: 5.08 mm, connection method: Crimp connection, color: green, Corresponding female crimp contacts with current [A] and conductor cross section range [mm<sup>2</sup>] data: 10A/MSTBC-MT 0,5-1,0 (3190564); 10A/MSTBC-MT 0,5-1,0 BA (3190645); 12A/MSTBC-MT 1,5-2,5 (3190551); 12A/MSTBC-MT 1,5-2,5 BA (3190658). BA = Bandkontakte



#### Printed-circuit board connector - MSTBC 2,5/17-STZ-5,08 - 1809653

PCB connector, nominal current: 12 A, rated voltage (III/2): 320 V, nominal cross section: 2.5 mm<sup>2</sup>, number of positions: 17, pitch: 5.08 mm, connection method: Crimp connection, color: green, Corresponding female crimp contacts with current [A] and conductor cross section range [mm<sup>2</sup>] data: 10A/MSTBC-MT 0,5-1,0 (3190564); 10A/MSTBC-MT 0,5-1,0 BA (3190645); 12A/MSTBC-MT 1,5-2,5 (3190551); 12A/MSTBC-MT 1,5-2,5 BA (3190658). BA = Bandkontakte



## Double-level terminal block - UKK 3-MSTB-5,08 - 2770888

### Accessories

#### Printed-circuit board connector - MSTBC 2,5/10-STZ-5,08 - 1809585



PCB connector, nominal current: 12 A, rated voltage (III/2): 320 V, nominal cross section: 2.5 mm<sup>2</sup>, number of positions: 10, pitch: 5.08 mm, connection method: Crimp connection, color: green, Corresponding female crimp contacts with current [A] and conductor cross section range [mm<sup>2</sup>] data: 10A/MSTBC-MT 0,5-1,0 (3190564); 10A/MSTBC-MT 0,5-1,0 BA (3190645); 12A/MSTBC-MT 1,5-2,5 (3190551); 12A/MSTBC-MT 1,5-2,5 BA (3190658). BA = Bandkontakte

#### Printed-circuit board connector - MSTBC 2,5/ 4-STZ-5,08 - 1809527



PCB connector, nominal current: 12 A, rated voltage (III/2): 320 V, nominal cross section: 2.5 mm<sup>2</sup>, number of positions: 4, pitch: 5.08 mm, connection method: Crimp connection, color: green, Corresponding female crimp contacts with current [A] and conductor cross section range [mm<sup>2</sup>] data: 10A/MSTBC-MT 0,5-1,0 (3190564); 10A/MSTBC-MT 0,5-1,0 BA (3190645); 12A/MSTBC-MT 1,5-2,5 (3190551); 12A/MSTBC-MT 1,5-2,5 BA (3190658). BA = Bandkontakte

#### Printed-circuit board connector - MSTBC 2,5/23-STZ-5,08 - 1809718



PCB connector, nominal current: 12 A, rated voltage (III/2): 320 V, nominal cross section: 2.5 mm<sup>2</sup>, number of positions: 23, pitch: 5.08 mm, connection method: Crimp connection, color: green, Corresponding female crimp contacts with current [A] and conductor cross section range [mm<sup>2</sup>] data: 10A/MSTBC-MT 0,5-1,0 (3190564); 10A/MSTBC-MT 0,5-1,0 BA (3190645); 12A/MSTBC-MT 1,5-2,5 (3190551); 12A/MSTBC-MT 1,5-2,5 BA (3190658). BA = Bandkontakte

#### Printed-circuit board connector - MSTBC 2,5/ 3-STZ-5,08 - 1809514



PCB connector, nominal current: 12 A, rated voltage (III/2): 320 V, nominal cross section: 2.5 mm<sup>2</sup>, number of positions: 3, pitch: 5.08 mm, connection method: Crimp connection, color: green, Corresponding female crimp contacts with current [A] and conductor cross section range [mm<sup>2</sup>] data: 10A/MSTBC-MT 0,5-1,0 (3190564); 10A/MSTBC-MT 0,5-1,0 BA (3190645); 12A/MSTBC-MT 1,5-2,5 (3190551); 12A/MSTBC-MT 1,5-2,5 BA (3190658). BA = Bandkontakte

#### Printed-circuit board connector - MSTBC 2,5/ 7-STZ-5,08 - 1809556



PCB connector, nominal current: 12 A, rated voltage (III/2): 320 V, nominal cross section: 2.5 mm<sup>2</sup>, number of positions: 7, pitch: 5.08 mm, connection method: Crimp connection, color: green, Corresponding female crimp contacts with current [A] and conductor cross section range [mm<sup>2</sup>] data: 10A/MSTBC-MT 0,5-1,0 (3190564); 10A/MSTBC-MT 0,5-1,0 BA (3190645); 12A/MSTBC-MT 1,5-2,5 (3190551); 12A/MSTBC-MT 1,5-2,5 BA (3190658). BA = Bandkontakte

## Double-level terminal block - UKK 3-MSTB-5,08 - 2770888

### Accessories

#### Printed-circuit board connector - MSTBC 2,5/ 8-STZ-5,08 - 1809569

PCB connector, nominal current: 12 A, rated voltage (III/2): 320 V, nominal cross section: 2.5 mm<sup>2</sup>, number of positions: 8, pitch: 5.08 mm, connection method: Crimp connection, color: green, Corresponding female crimp contacts with current [A] and conductor cross section range [mm<sup>2</sup>] data: 10A/MSTBC-MT 0,5-1,0 (3190564); 10A/MSTBC-MT 0,5-1,0 BA (3190645); 12A/MSTBC-MT 1,5-2,5 (3190551); 12A/MSTBC-MT 1,5-2,5 BA (3190658). BA = Bandkontakte



#### Printed-circuit board connector - MSTBC 2,5/11-STZ-5,08 - 1809598

PCB connector, nominal current: 12 A, rated voltage (III/2): 320 V, nominal cross section: 2.5 mm<sup>2</sup>, number of positions: 11, pitch: 5.08 mm, connection method: Crimp connection, color: green, Corresponding female crimp contacts with current [A] and conductor cross section range [mm<sup>2</sup>] data: 10A/MSTBC-MT 0,5-1,0 (3190564); 10A/MSTBC-MT 0,5-1,0 BA (3190645); 12A/MSTBC-MT 1,5-2,5 (3190551); 12A/MSTBC-MT 1,5-2,5 BA (3190658). BA = Bandkontakte



#### Printed-circuit board connector - MSTBC 2,5/18-STZ-5,08 - 1809666

PCB connector, nominal current: 12 A, rated voltage (III/2): 320 V, nominal cross section: 2.5 mm<sup>2</sup>, number of positions: 18, pitch: 5.08 mm, connection method: Crimp connection, color: green, Corresponding female crimp contacts with current [A] and conductor cross section range [mm<sup>2</sup>] data: 10A/MSTBC-MT 0,5-1,0 (3190564); 10A/MSTBC-MT 0,5-1,0 BA (3190645); 12A/MSTBC-MT 1,5-2,5 (3190551); 12A/MSTBC-MT 1,5-2,5 BA (3190658). BA = Bandkontakte



#### Printed-circuit board connector - MSTB 2,5/ 3-STF-5,08 - 1777992

PCB connector, nominal current: 12 A, rated voltage (III/2): 320 V, nominal cross section: 2.5 mm<sup>2</sup>, number of positions: 3, pitch: 5.08 mm, connection method: Screw connection with tension sleeve, color: green, contact surface: Tin



#### Printed-circuit board connector - MSTB 2,5/ 6-STF-5,08 - 1778027

PCB connector, nominal current: 12 A, rated voltage (III/2): 320 V, nominal cross section: 2.5 mm<sup>2</sup>, number of positions: 6, pitch: 5.08 mm, connection method: Screw connection with tension sleeve, color: green, contact surface: Tin



## Double-level terminal block - UKK 3-MSTB-5,08 - 2770888

### Accessories

#### Printed-circuit board connector - MSTB 2,5/ 8-STF-5,08 - 1778043

PCB connector, nominal current: 12 A, rated voltage (III/2): 320 V, nominal cross section: 2.5 mm<sup>2</sup>, number of positions: 8, pitch: 5.08 mm, connection method: Screw connection with tension sleeve, color: green, contact surface: Tin



#### Printed-circuit board connector - MSTB 2,5/15-STF-5,08 - 1778111

PCB connector, nominal current: 12 A, rated voltage (III/2): 320 V, nominal cross section: 2.5 mm<sup>2</sup>, number of positions: 15, pitch: 5.08 mm, connection method: Screw connection with tension sleeve, color: green, contact surface: Tin



#### Printed-circuit board connector - MSTB 2,5/16-STF-5,08 - 1778124

PCB connector, nominal current: 12 A, rated voltage (III/2): 320 V, nominal cross section: 2.5 mm<sup>2</sup>, number of positions: 16, pitch: 5.08 mm, connection method: Screw connection with tension sleeve, color: green, contact surface: Tin



#### Printed-circuit board connector - MSTB 2,5/17-STF-5,08 - 1778137

PCB connector, nominal current: 12 A, rated voltage (III/2): 320 V, nominal cross section: 2.5 mm<sup>2</sup>, number of positions: 17, pitch: 5.08 mm, connection method: Screw connection with tension sleeve, color: green, contact surface: Tin



#### Printed-circuit board connector - MSTB 2,5/12-STF-5,08 - 1778085

PCB connector, nominal current: 12 A, rated voltage (III/2): 320 V, nominal cross section: 2.5 mm<sup>2</sup>, number of positions: 12, pitch: 5.08 mm, connection method: Screw connection with tension sleeve, color: green, contact surface: Tin



## Double-level terminal block - UKK 3-MSTB-5,08 - 2770888

### Accessories

#### Printed-circuit board connector - MSTB 2,5/ 5-STF-5,08 - 1778014

PCB connector, nominal current: 12 A, rated voltage (III/2): 320 V, nominal cross section: 2.5 mm<sup>2</sup>, number of positions: 5, pitch: 5.08 mm, connection method: Screw connection with tension sleeve, color: green, contact surface: Tin



#### Printed-circuit board connector - MSTB 2,5/ 9-STF-5,08 - 1778056

PCB connector, nominal current: 12 A, rated voltage (III/2): 320 V, nominal cross section: 2.5 mm<sup>2</sup>, number of positions: 9, pitch: 5.08 mm, connection method: Screw connection with tension sleeve, color: green, contact surface: Tin



#### Printed-circuit board connector - MSTB 2,5/14-STF-5,08 - 1778108

PCB connector, nominal current: 12 A, rated voltage (III/2): 320 V, nominal cross section: 2.5 mm<sup>2</sup>, number of positions: 14, pitch: 5.08 mm, connection method: Screw connection with tension sleeve, color: green, contact surface: Tin



#### Printed-circuit board connector - MSTB 2,5/ 2-STF-5,08 - 1777989

PCB connector, nominal current: 12 A, rated voltage (III/2): 320 V, nominal cross section: 2.5 mm<sup>2</sup>, number of positions: 2, pitch: 5.08 mm, connection method: Screw connection with tension sleeve, color: green, contact surface: Tin



#### Printed-circuit board connector - MSTB 2,5/18-STF-5,08 - 1778140

PCB connector, nominal current: 12 A, rated voltage (III/2): 320 V, nominal cross section: 2.5 mm<sup>2</sup>, number of positions: 18, pitch: 5.08 mm, connection method: Screw connection with tension sleeve, color: green, contact surface: Tin





## Double-level terminal block - UKK 3-MSTB-5,08 - 2770888

### Accessories

#### Printed-circuit board connector - MSTB 2,5/11-STF-5,08 - 1778072

PCB connector, nominal current: 12 A, rated voltage (III/2): 320 V, nominal cross section: 2.5 mm<sup>2</sup>, number of positions: 11, pitch: 5.08 mm, connection method: Screw connection with tension sleeve, color: green, contact surface: Tin



---

#### Printed-circuit board connector - MSTB 2,5/ 4-STF-5,08 - 1778001

PCB connector, nominal current: 12 A, rated voltage (III/2): 320 V, nominal cross section: 2.5 mm<sup>2</sup>, number of positions: 4, pitch: 5.08 mm, connection method: Screw connection with tension sleeve, color: green, contact surface: Tin



---

#### Printed-circuit board connector - MSTB 2,5/ 7-STF-5,08 - 1778030

PCB connector, nominal current: 12 A, rated voltage (III/2): 320 V, nominal cross section: 2.5 mm<sup>2</sup>, number of positions: 7, pitch: 5.08 mm, connection method: Screw connection with tension sleeve, color: green, contact surface: Tin



---

#### Printed-circuit board connector - MSTB 2,5/10-STF-5,08 - 1778069

PCB connector, nominal current: 12 A, rated voltage (III/2): 320 V, nominal cross section: 2.5 mm<sup>2</sup>, number of positions: 10, pitch: 5.08 mm, connection method: Screw connection with tension sleeve, color: green, contact surface: Tin



---

#### Printed-circuit board connector - MSTB 2,5/13-STF-5,08 - 1778098

PCB connector, nominal current: 12 A, rated voltage (III/2): 320 V, nominal cross section: 2.5 mm<sup>2</sup>, number of positions: 13, pitch: 5.08 mm, connection method: Screw connection with tension sleeve, color: green, contact surface: Tin



## Double-level terminal block - UKK 3-MSTB-5,08 - 2770888

### Accessories

#### Printed-circuit board connector - MSTB 2,5/19-STF-5,08 - 1778153

PCB connector, nominal current: 12 A, rated voltage (III/2): 320 V, nominal cross section: 2.5 mm<sup>2</sup>, number of positions: 19, pitch: 5.08 mm, connection method: Screw connection with tension sleeve, color: green, contact surface: Tin



#### Plug - MSTB 2,5/20-STF-5,08 - 1778166

PCB connector, nominal current: 12 A, rated voltage (III/2): 320 V, nominal cross section: 2.5 mm<sup>2</sup>, number of positions: 20, pitch: 5.08 mm, connection method: Screw connection with tension sleeve, color: green, contact surface: Tin



#### Printed-circuit board connector - MSTBT 2,5/ 2-STF-5,08 - 1805301

PCB connector, nominal current: 12 A, rated voltage (III/2): 320 V, nominal cross section: 2.5 mm<sup>2</sup>, number of positions: 2, pitch: 5.08 mm, connection method: Screw connection with tension sleeve, color: green, contact surface: Tin



#### Printed-circuit board connector - MSTBT 2,5/12-STF-5,08 - 1805398

PCB connector, nominal current: 12 A, rated voltage (III/2): 320 V, nominal cross section: 2.5 mm<sup>2</sup>, number of positions: 12, pitch: 5.08 mm, connection method: Screw connection with tension sleeve, color: green, contact surface: Tin



#### Printed-circuit board connector - MSTBT 2,5/10-STF-5,08 - 1805372

PCB connector, nominal current: 12 A, rated voltage (III/2): 320 V, nominal cross section: 2.5 mm<sup>2</sup>, number of positions: 10, pitch: 5.08 mm, connection method: Screw connection with tension sleeve, color: green, contact surface: Tin



## Double-level terminal block - UKK 3-MSTB-5,08 - 2770888

### Accessories

#### Printed-circuit board connector - MSTBT 2,5/11-STF-5,08 - 1805385

PCB connector, nominal current: 12 A, rated voltage (III/2): 320 V, nominal cross section: 2.5 mm<sup>2</sup>, number of positions: 11, pitch: 5.08 mm, connection method: Screw connection with tension sleeve, color: green, contact surface: Tin



---

#### Printed-circuit board connector - FKC 2,5/ 8-STF-5,08 - 1873265

PCB connector, nominal current: 12 A, rated voltage (III/2): 320 V, nominal cross section: 2.5 mm<sup>2</sup>, number of positions: 8, pitch: 5.08 mm, connection method: Push-in spring connection, color: green, contact surface: Tin



---

#### Printed-circuit board connector - FKC 2,5/ 5-STF-5,08 - 1873236

PCB connector, nominal current: 12 A, rated voltage (III/2): 320 V, nominal cross section: 2.5 mm<sup>2</sup>, number of positions: 5, pitch: 5.08 mm, connection method: Push-in spring connection, color: green, contact surface: Tin



---

#### Printed-circuit board connector - FKC 2,5/ 2-STF-5,08 - 1873207

PCB connector, nominal current: 12 A, rated voltage (III/2): 320 V, nominal cross section: 2.5 mm<sup>2</sup>, number of positions: 2, pitch: 5.08 mm, connection method: Push-in spring connection, color: green, contact surface: Tin



---

#### Printed-circuit board connector - FKC 2,5/14-STF-5,08 - 1873320

PCB connector, nominal current: 12 A, rated voltage (III/2): 320 V, nominal cross section: 2.5 mm<sup>2</sup>, number of positions: 14, pitch: 5.08 mm, connection method: Push-in spring connection, color: green, contact surface: Tin



## Double-level terminal block - UKK 3-MSTB-5,08 - 2770888

### Accessories

#### Printed-circuit board connector - FKC 2,5/ 9-STF-5,08 - 1873278

PCB connector, nominal current: 12 A, rated voltage (III/2): 320 V, nominal cross section: 2.5 mm<sup>2</sup>, number of positions: 9, pitch: 5.08 mm, connection method: Push-in spring connection, color: green, contact surface: Tin



---

#### Printed-circuit board connector - QC 1/ 2-STF-5,08 - 1883352

PCB connector, nominal current: 10 A, rated voltage (III/2): 630 V, nominal cross section: 1 mm<sup>2</sup>, number of positions: 2, pitch: 5.08 mm, connection method: Displacement connection, color: green, contact surface: Tin



---

#### Printed-circuit board connector - QC 1/ 3-STF-5,08 - 1883365

PCB connector, nominal current: 10 A, rated voltage (III/2): 630 V, nominal cross section: 1 mm<sup>2</sup>, number of positions: 3, pitch: 5.08 mm, connection method: Displacement connection, color: green, contact surface: Tin



---

#### Printed-circuit board connector - QC 1/ 7-STF-5,08 - 1883404

PCB connector, nominal current: 10 A, rated voltage (III/2): 630 V, nominal cross section: 1 mm<sup>2</sup>, number of positions: 7, pitch: 5.08 mm, connection method: Displacement connection, color: green, contact surface: Tin



---

#### Printed-circuit board connector - QC 1/15-STF-5,08 - 1883886

PCB connector, nominal current: 10 A, rated voltage (III/2): 630 V, nominal cross section: 1 mm<sup>2</sup>, number of positions: 15, pitch: 5.08 mm, connection method: Displacement connection, color: green, contact surface: Tin



## Double-level terminal block - UKK 3-MSTB-5,08 - 2770888

### Accessories

#### Printed-circuit board connector - QC 1/12-STF-5,08 - 1883459



PCB connector, nominal current: 10 A, rated voltage (III/2): 630 V, nominal cross section: 1 mm<sup>2</sup>, number of positions: 12, pitch: 5.08 mm, connection method: Displacement connection, color: green, contact surface: Tin

#### Printed-circuit board connector - MSTBC 2,5/ 8-STZF-5,08 - 1809792



PCB connector, nominal current: 12 A, rated voltage (III/2): 320 V, nominal cross section: 2.5 mm<sup>2</sup>, number of positions: 8, pitch: 5.08 mm, connection method: Crimp connection, color: green, Corresponding female crimp contacts with current [A] and conductor cross section range [mm<sup>2</sup>] data: 10A/MSTBC-MT 0,5-1,0 (3190564); 10A/MSTBC-MT 0,5-1,0 BA (3190645); 12A/MSTBC-MT 1,5-2,5 (3190551); 12A/MSTBC-MT 1,5-2,5 BA (3190658). BA = Bandkontakte

#### Printed-circuit board connector - MSTBC 2,5/19-STZF-5,08 - 1809909



PCB connector, nominal current: 12 A, rated voltage (III/2): 320 V, nominal cross section: 2.5 mm<sup>2</sup>, number of positions: 19, pitch: 5.08 mm, connection method: Crimp connection, color: green, Corresponding female crimp contacts with current [A] and conductor cross section range [mm<sup>2</sup>] data: 10A/MSTBC-MT 0,5-1,0 (3190564); 10A/MSTBC-MT 0,5-1,0 BA (3190645); 12A/MSTBC-MT 1,5-2,5 (3190551); 12A/MSTBC-MT 1,5-2,5 BA (3190658). BA = Bandkontakte

#### Printed-circuit board connector - MSTBC 2,5/ 9-STZF-5,08 - 1809802



PCB connector, nominal current: 12 A, rated voltage (III/2): 320 V, nominal cross section: 2.5 mm<sup>2</sup>, number of positions: 9, pitch: 5.08 mm, connection method: Crimp connection, color: green, Corresponding female crimp contacts with current [A] and conductor cross section range [mm<sup>2</sup>] data: 10A/MSTBC-MT 0,5-1,0 (3190564); 10A/MSTBC-MT 0,5-1,0 BA (3190645); 12A/MSTBC-MT 1,5-2,5 (3190551); 12A/MSTBC-MT 1,5-2,5 BA (3190658). BA = Bandkontakte

#### Printed-circuit board connector - MSTBC 2,5/ 6-STZF-5,08 - 1809776



PCB connector, nominal current: 12 A, rated voltage (III/2): 320 V, nominal cross section: 2.5 mm<sup>2</sup>, number of positions: 6, pitch: 5.08 mm, connection method: Crimp connection, color: green, Corresponding female crimp contacts with current [A] and conductor cross section range [mm<sup>2</sup>] data: 10A/MSTBC-MT 0,5-1,0 (3190564); 10A/MSTBC-MT 0,5-1,0 BA (3190645); 12A/MSTBC-MT 1,5-2,5 (3190551); 12A/MSTBC-MT 1,5-2,5 BA (3190658). BA = Bandkontakte

## Double-level terminal block - UKK 3-MSTB-5,08 - 2770888

### Accessories

Printed-circuit board connector - MSTBC 2,5/18-STZF-5,08 - 1809899

PCB connector, nominal current: 12 A, rated voltage (III/2): 320 V, nominal cross section: 2.5 mm<sup>2</sup>, number of positions: 18, pitch: 5.08 mm, connection method: Crimp connection, color: green, Corresponding female crimp contacts with current [A] and conductor cross section range [mm<sup>2</sup>] data: 10A/MSTBC-MT 0,5-1,0 (3190564); 10A/MSTBC-MT 0,5-1,0 BA (3190645); 12A/MSTBC-MT 1,5-2,5 (3190551); 12A/MSTBC-MT 1,5-2,5 BA (3190658). BA = Bandkontakte



---

Phoenix Contact 2020 © - all rights reserved  
<http://www.phoenixcontact.com>

PHOENIX CONTACT GmbH & Co. KG  
Flachsmarktstr. 8  
32825 Blomberg  
Germany  
Tel. +49 5235 300  
Fax +49 5235 3 41200  
<http://www.phoenixcontact.com>

## X-ON Electronics

Largest Supplier of Electrical and Electronic Components

*Click to view similar products for [DIN Rail Terminal Blocks](#) category:*

*Click to view products by [Phoenix Contact](#) manufacturer:*

Other Similar products are found below :

[00110420202](#) [8WA1011-1BH23](#) [8WA1011-1EF20](#) [91.010](#) [9102100000](#) [91.040](#) [9123140000](#) [9123140001](#) [RBO 5-T-B-HEX](#) [1333564](#) [DP25-GY-ND](#) [1431306](#) [1433306](#) [90.070](#) [91.020](#) [912314](#) [260-301\\_NR](#) [2757571](#) [280-331](#) [280-560](#) [280-564](#) [281-611/281-542](#) [281-673/281-411](#) [281-994](#) [283-317](#) [283-607](#) [2909798](#) [264-724](#) [264-726](#) [280-530](#) [280-555](#) [280-619](#) [281-610](#) [281-622/281-417](#) [284-317](#) [284-601](#) [2907033](#) [3048496](#) [5542152](#) [35956](#) [USK 10](#) [102510](#) [1025100000](#) [5520682](#) [5607102](#) [EMH 25-ZE30](#) [591620-2](#) [UM 45-SEFE M.NUT BK](#) [1-591651-1](#) [8671050000](#)