

Single relay - REL-IR/LDM- 48DC/4X21AU - 2834216

Please be informed that the data shown in this PDF Document is generated from our Online Catalog. Please find the complete data in the user's documentation. Our General Terms of Use for Downloads are valid (<http://phoenixcontact.com/download>)



Pluggable industrial relays with power contacts and additional hard gold plating, 4 PDT, test button, status LED, free-wheeling diode, mechanical switch position indicator, polarity A1-, A2+, coil voltage: 48 V DC

Your advantages

- ✓ With detectable manual operation
- ✓ DC types with integrated freewheeling diode
- ✓ Integrated status LED
- ✓ Mechanical switch position indicator

Key Commercial Data

Packing unit	10 pc
Minimum order quantity	10 pc
GTIN	 4 017918 941741
GTIN	4017918941741

Technical data

Dimensions

Width	21.5 mm
Height	28 mm
Depth	36 mm

Ambient conditions

Ambient temperature (operation)	-55 °C ... 70 °C
Ambient temperature (storage/transport)	-55 °C ... 70 °C

Coil side

Nominal input voltage U_N	48 V DC
Typical input current at U_N	19 mA
Typical response time	13 ms

Single relay - REL-IR/LDM- 48DC/4X21AU - 2834216

Technical data

Coil side

Typical release time	14 ms
Coil resistance	2560 Ω ±15 % (at 20 °C)
Power dissipation for nominal condition	0.91 W

Contact side

Contact type	4 PDTs
Type of switch contact	Single contact
Contact material	AgNi, hard gold-plated
Maximum switching voltage	250 V AC/DC
Minimum switching voltage	1 V
Min. switching current	1 mA
Maximum inrush current	12 A (15 ms)
Limiting continuous current	5 A
Interrupting rating (ohmic load) max.	1250 VA (for 250 V AC)

General

Test voltage relay winding/relay contact	2 kV AC (50 Hz, 1 min.)
Test voltage relay contact/relay contact	2 kV AC (50 Hz, 1 min.)
Operating mode	100% operating factor
Mechanical service life	5x 10 ⁷ cycles
Service life, electrical	see diagram
Mounting position	any
Assembly instructions	On relay base PR2

Standards and Regulations

Standards/regulations	DIN EN 61810-1
	VDE 0435-201
	EN 50178
Pollution degree	2
Overvoltage category	II

Environmental Product Compliance

China RoHS	Environmentally friendly use period: unlimited = EFUP-e
	No hazardous substances above threshold values

Drawings

Single relay - REL-IR/LDM- 48DC/4X21AU - 2834216

Diagram

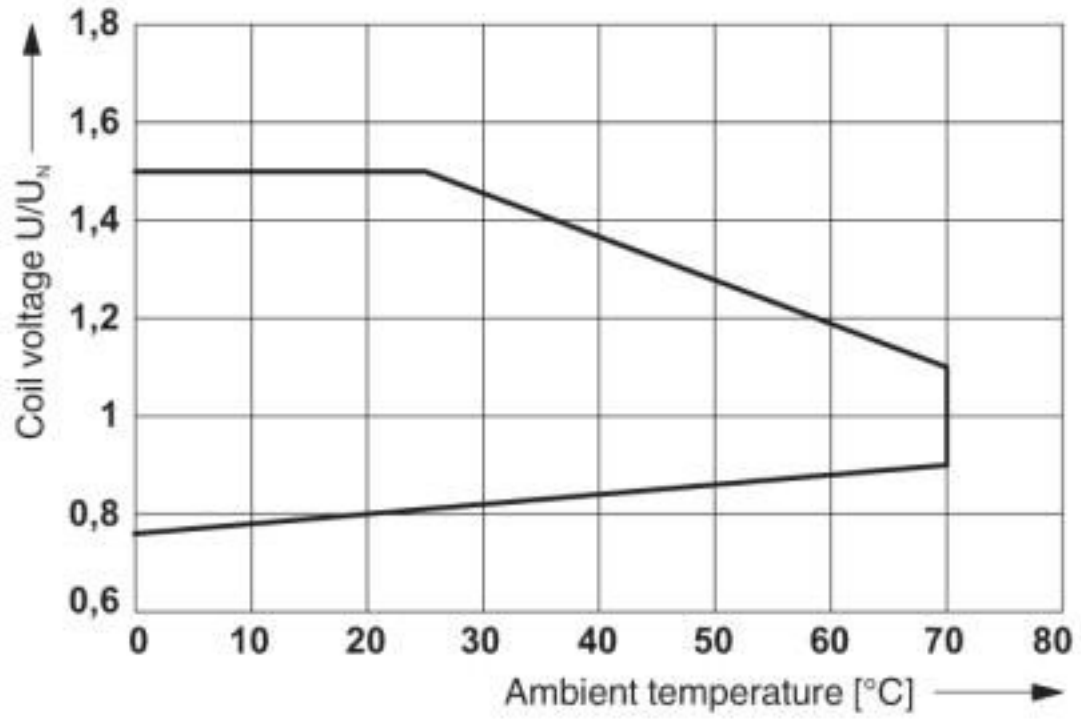

Operating voltage range

Single relay - REL-IR/LDM- 48DC/4X21AU - 2834216

Diagram

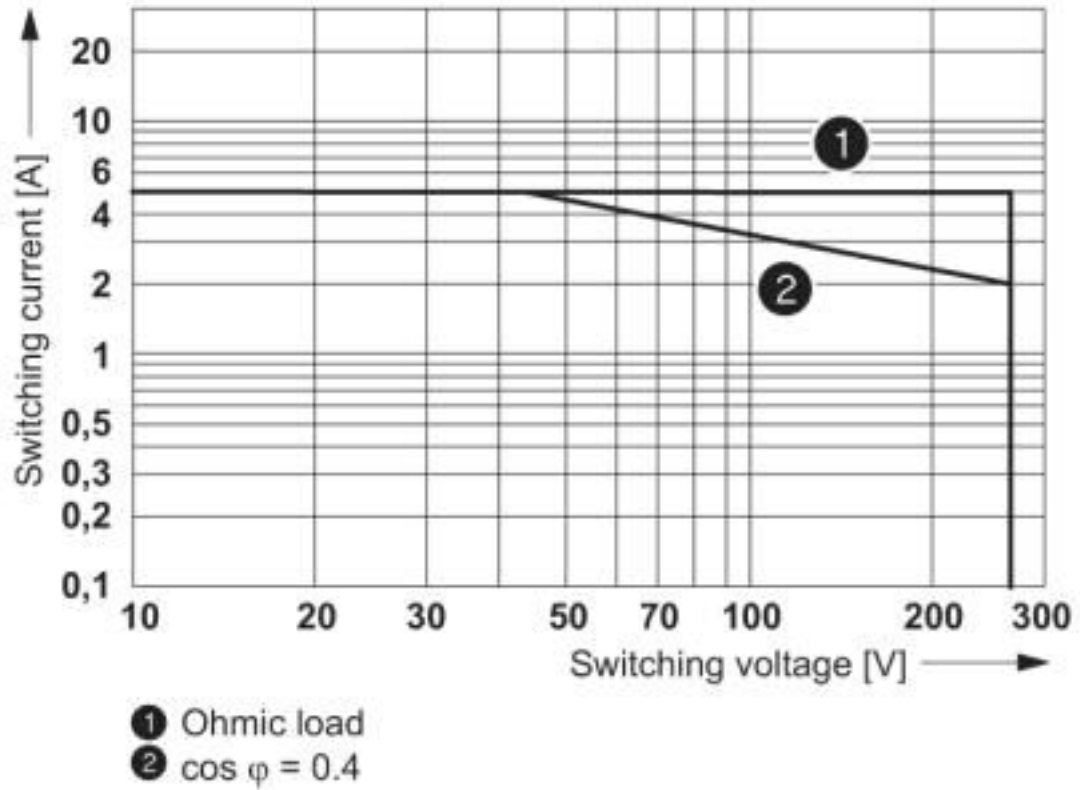

AC interrupting rating

Single relay - REL-IR/LDM- 48DC/4X21AU - 2834216

Diagram

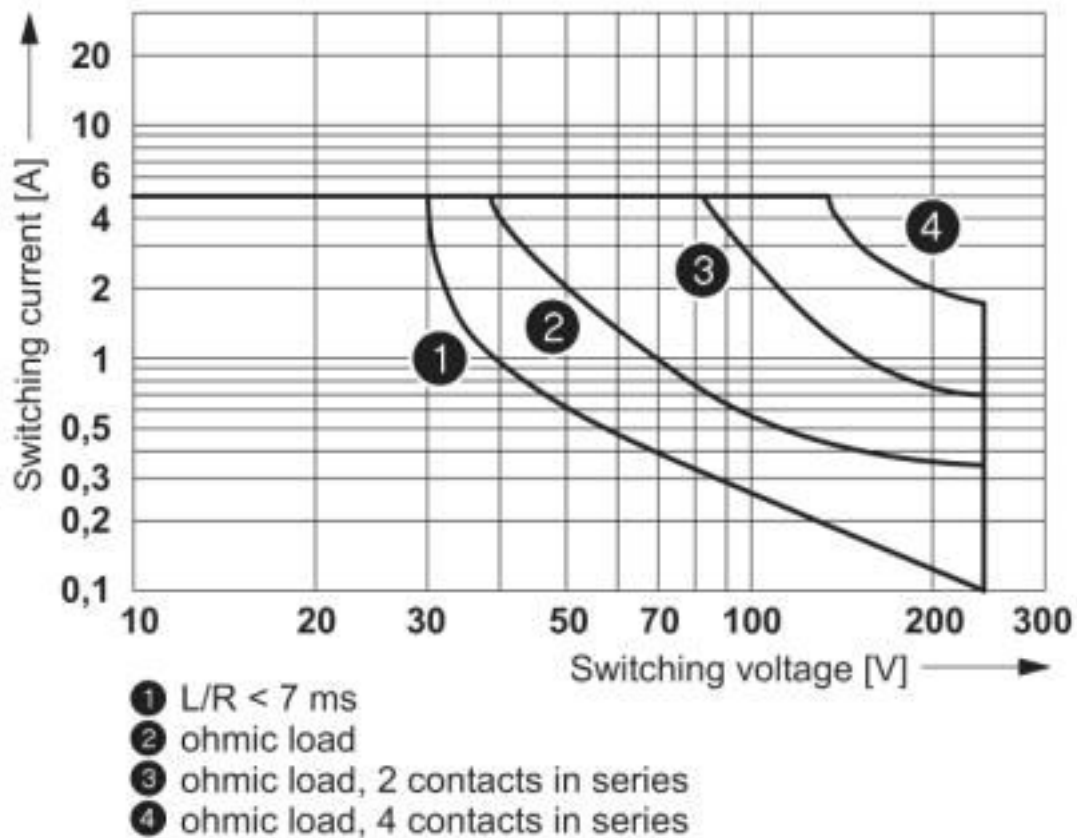

DC interrupting rating

Single relay - REL-IR/LDM- 48DC/4X21AU - 2834216

Diagram

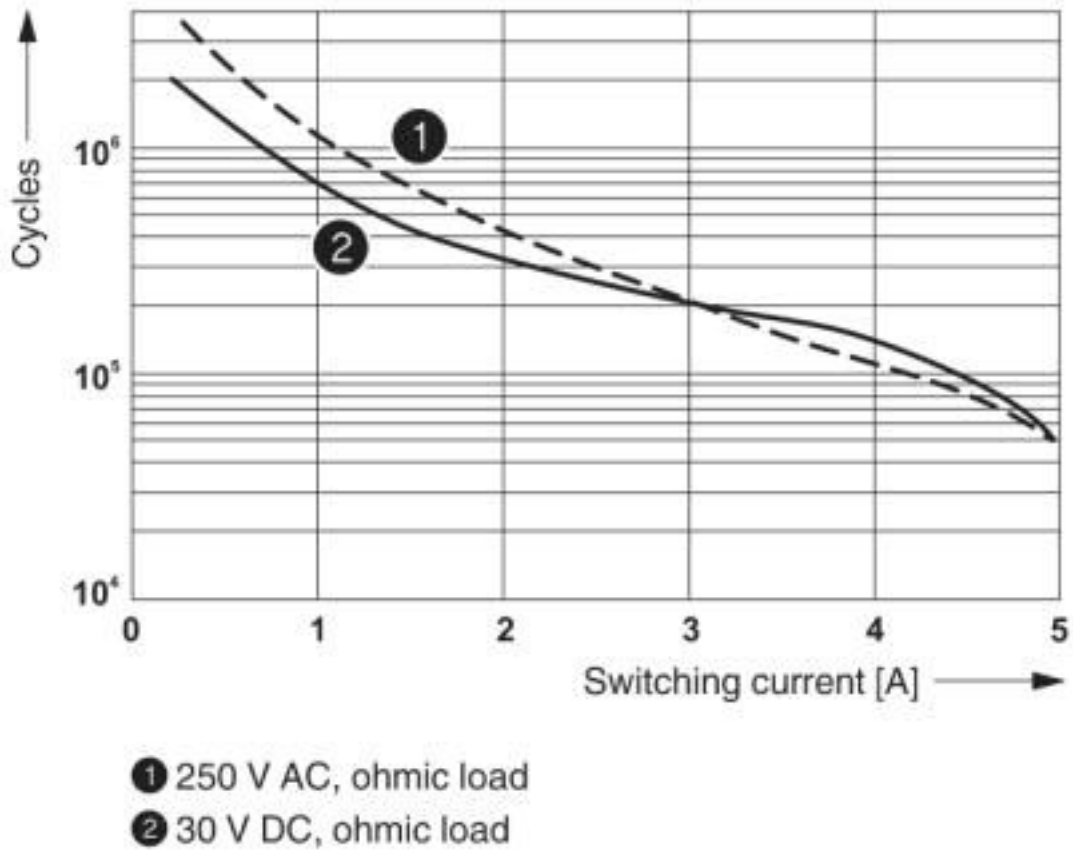

Electrical service life

Single relay - REL-IR/LDM- 48DC/4X21AU - 2834216

Diagram

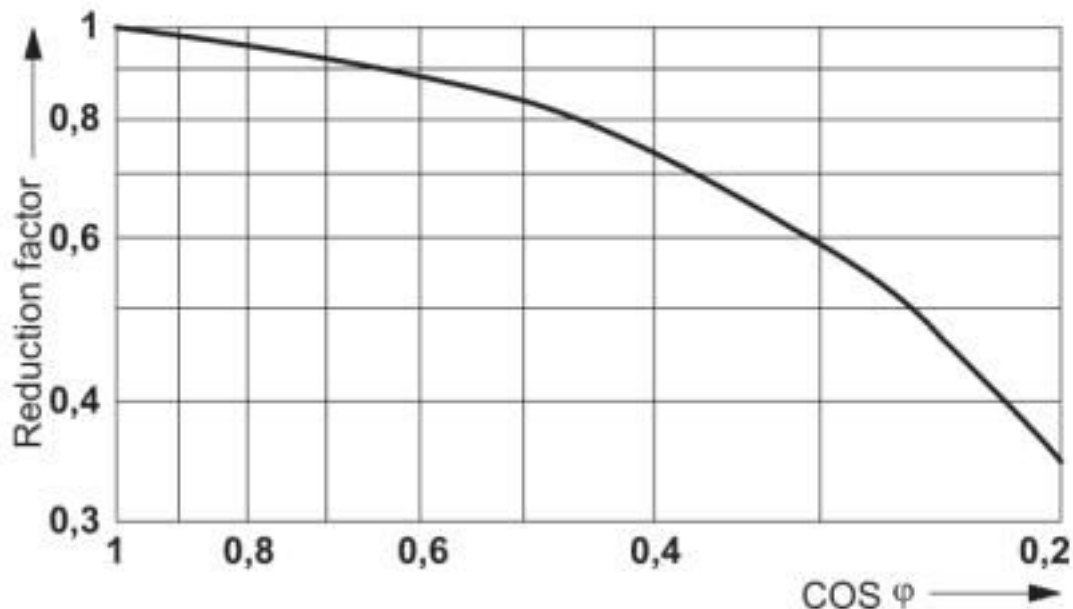

Service life reduction factor

Circuit diagram

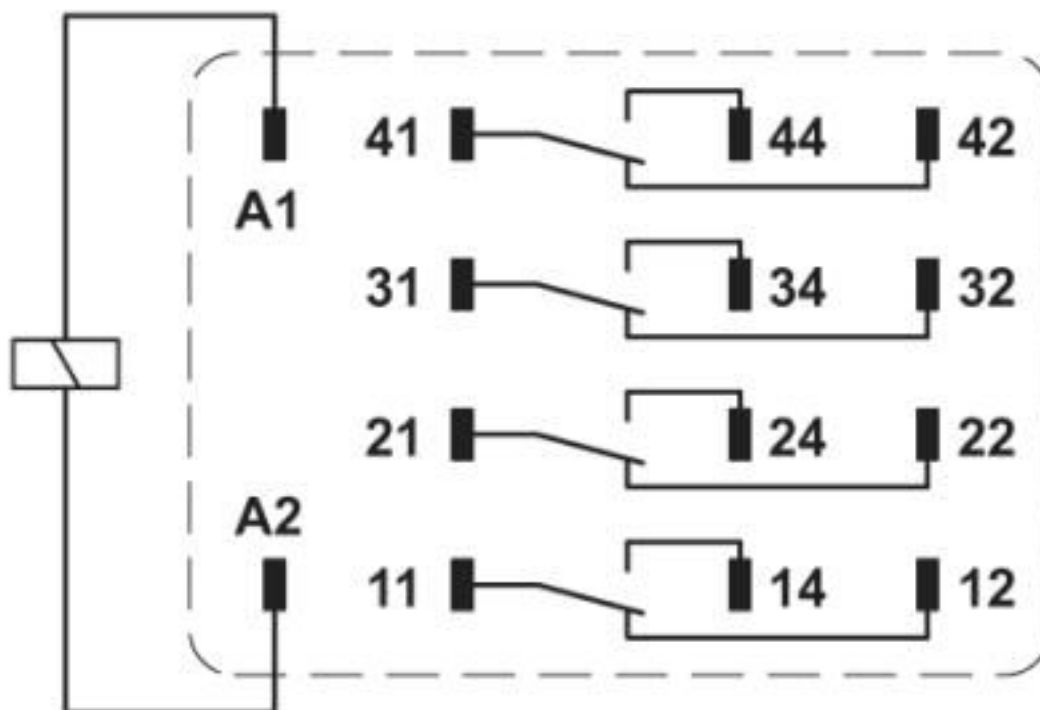

Shown without LED and damping diode.

Single relay - REL-IR/LDM- 48DC/4X21AU - 2834216

Classifications

eCl@ss

eCl@ss 4.0	27371100
eCl@ss 4.1	27371100
eCl@ss 5.0	27371600
eCl@ss 5.1	27371600
eCl@ss 6.0	27371600
eCl@ss 7.0	27371601
eCl@ss 8.0	27371601
eCl@ss 9.0	27371601

ETIM

ETIM 2.0	EC001437
ETIM 3.0	EC001437
ETIM 4.0	EC001437
ETIM 5.0	EC001437
ETIM 6.0	EC001437
ETIM 7.0	EC001437

UNSPSC

UNSPSC 6.01	30211916
UNSPSC 7.0901	39121515
UNSPSC 11	39121515
UNSPSC 12.01	39121515
UNSPSC 13.2	39122334
UNSPSC 18.0	39122334
UNSPSC 19.0	39122334
UNSPSC 20.0	39122334
UNSPSC 21.0	39122334

Approvals

Approvals

Approvals

UL Listed / VDE Gutachten mit Fertigungsüberwachung / cUL Listed / EAC / EAC / cULus Listed

Ex Approvals

Approval details

Single relay - REL-IR/LDM- 48DC/4X21AU - 2834216

Approvals

UL Listed		http://database.ul.com/cgi-bin/XYV/template/LISEXT/1FRAME/index.htm	FILE E 172140
-----------	--	---	---------------

VDE Gutachten mit Fertigungsüberwachung		http://www2.vde.com/de/Institut/Online-Service/VDE-gepruefteProdukte/Seiten/Online-Suche.aspx	40026798
---	--	---	----------

cUL Listed		http://database.ul.com/cgi-bin/XYV/template/LISEXT/1FRAME/index.htm	FILE E 172140
------------	--	---	---------------

EAC			TR_TS_D_00573_c
-----	--	--	-----------------

EAC			RU*C-DE.*08.B.00010
-----	--	--	---------------------

cULus Listed			
--------------	--	--	--

Accessories

Additional products

Relay base - PR2-BSC2/4X21 - 2833563



Relay base PR2-B, for industrial relay REL-IR with 2 or 4 PDT, 2/2-level version, screw connections, connection facility for input/interference suppression modules, for mounting on NS 35/7.5

Relay base - PR2-BSC3/4X21 - 2833576



Relay base PR2-B, for industrial relay REL-IR with 2 or 4 PDT, 1/3-level version, screw connections, connection facility for input/interference suppression modules, for mounting on NS 35/7.5

Single relay - REL-IR/LDM- 48DC/4X21AU - 2834216

Accessories

Relay base - PR2-BSP3/4X21 - 2833589



Relay base PR2-B, for industrial relay REL-IR with 2 or 4 PDT, 1/3-level version, spring-cage connections, connection facility for input/interference suppression modules, for mounting on NS 35/7.5

Phoenix Contact 2020 © - all rights reserved
<http://www.phoenixcontact.com>

PHOENIX CONTACT GmbH & Co. KG
Flachsmarktstr. 8
32825 Blomberg
Germany
Tel. +49 5235 300
Fax +49 5235 3 41200
<http://www.phoenixcontact.com>

X-ON Electronics

Largest Supplier of Electrical and Electronic Components

Click to view similar products for [Industrial Relays](#) category:

Click to view products by [Phoenix Contact](#) manufacturer:

Other Similar products are found below :

[6-1617801-8](#) [6-1618107-9](#) [7-1618273-3](#) [EV250-4A-02](#) [EV250-6A-01](#) [FCA-125-CX8](#) [FCA-325-159](#) [FCA-410-138](#) [8000-S3121](#) [8-1618273-6](#)
[8-1618393-1](#) [GCA63A220VAC60HZ](#) [GCA63A277VAC60HZ](#) [GCA63A600VAC60HZ](#) [1-1672275-3](#) [1-1833005-4](#) [H-16/S1](#) [A711Z](#) [H-8C](#)
[H-8/S11](#) [H-8/S68](#) [ACC530U20](#) [ACC730U30](#) [RF303ZM4-12](#) [DH18DA](#) [1423675-8](#) [AR4-15F13-C01](#) [AR7-41F11](#) [AVR907](#) [15732A200](#)
[B07B032AC1-0329](#) [B329](#) [B490A](#) [1618279-1](#) [BHR124Y](#) [1810DDB-SX](#) [N417](#) [P30C42A12D1-120](#) [2-1617748-6](#) [2-1618375-1](#) [2-1618396-6](#)
[2-1618398-1](#) [JMAPD-5XL](#) [JMGACD-5M](#) [JMGSC-5LW](#) [JMGSCD-5L](#) [PBO-18A1218](#) [PBO-40A3040](#) [K8DSPH1200480VAC](#) [KA-3C-12A](#)