

# Inline terminal - IB IL 24 PWR IN-PAC - 2861331

Please be informed that the data shown in this PDF Document is generated from our Online Catalog. Please find the complete data in the user's documentation. Our General Terms of Use for Downloads are valid (<http://phoenixcontact.com/download>)



Inline power terminal, complete with accessories (connector and labeling field), 24 V DC, without fuse

## Product Description

The terminal is designed for use within an Inline station. It enables the 24 V supply voltage to be fed into the main circuit ( $U_M$ ). In addition, this terminal can be used to supply power for a 24 V segment circuit ( $U_S$ ).

## Your advantages

- Supply of the 24 V main voltage  $U_M$
- Feed-in or provision of the 24 V segment voltage  $U_S$
- Main circuit protected by an external fuse
- Segment circuit can be protected by an external fuse



- MUXE

## Key Commercial Data

Packing unit	1 pc
GTIN	 4 017918 894276
GTIN	4017918894276

## Technical data

### Note

Utilization restriction	EMC: class A product, see manufacturer's declaration in the download area
-------------------------	---

### Dimensions

Width	12.2 mm
Height	119.8 mm
Depth	71.5 mm

### Interfaces

Connection method	Inline data jumper
-------------------	--------------------

# Inline terminal - IB IL 24 PWR IN-PAC - 2861331

## Technical data

### Interfaces

Interface	Inline local bus
-----------	------------------

### General

Type of protection	Surge protection
	Reverse polarity protection
	Overload protection, short-circuit protection in the segment circuit
Weight	59 g
Number of plugs	1

### Inline potentials

Designation	Main circuit supply ( $U_M$ )
Supply voltage	24 V DC (via Inline connector)
Supply voltage range	19.2 V ... 30 V (including all tolerances, including ripple)
Power supply unit	max. 8 A (Sum of $U_M + U_S$ ; 4 A, maximum, when used in potentially explosive areas.)
Designation	Segment circuit supply ( $U_S$ )
Supply voltage	24 V DC (via Inline connector)
Supply voltage range	19.2 V DC ... 30 V DC (including all tolerances, including ripple)
Power supply unit	max. 8 A (Sum of $U_M + U_S$ ; 4 A, maximum, when used in potentially explosive areas.)

### Standards and Regulations

Connection in acc. with standard	CUL
----------------------------------	-----

### Environmental Product Compliance

REACH SVHC	Lead 7439-92-1
China RoHS	Environmentally Friendly Use Period = 50 years
	For details about hazardous substances go to tab "Downloads", Category "Manufacturer's declaration"

## Drawings

# Inline terminal - IB IL 24 PWR IN-PAC - 2861331

Block diagram

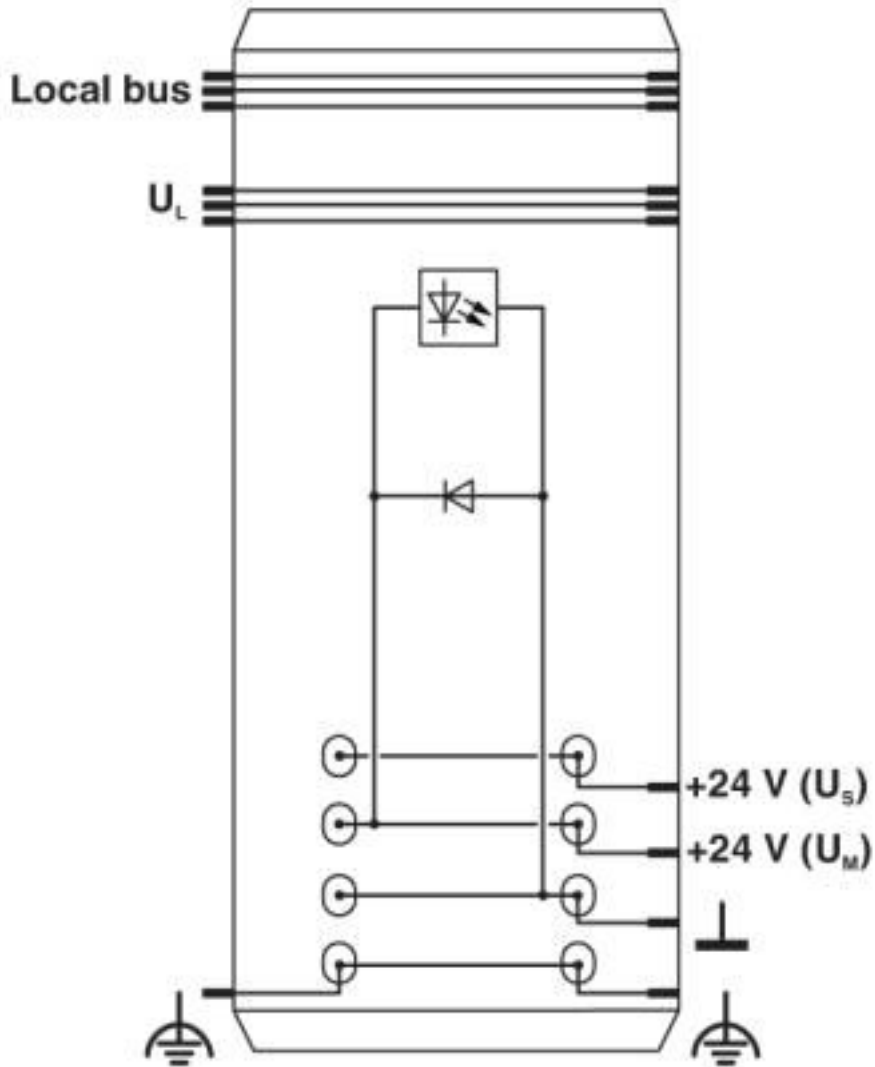

Internal wiring of the terminal points

# Inline terminal - IB IL 24 PWR IN-PAC - 2861331

Connection diagram

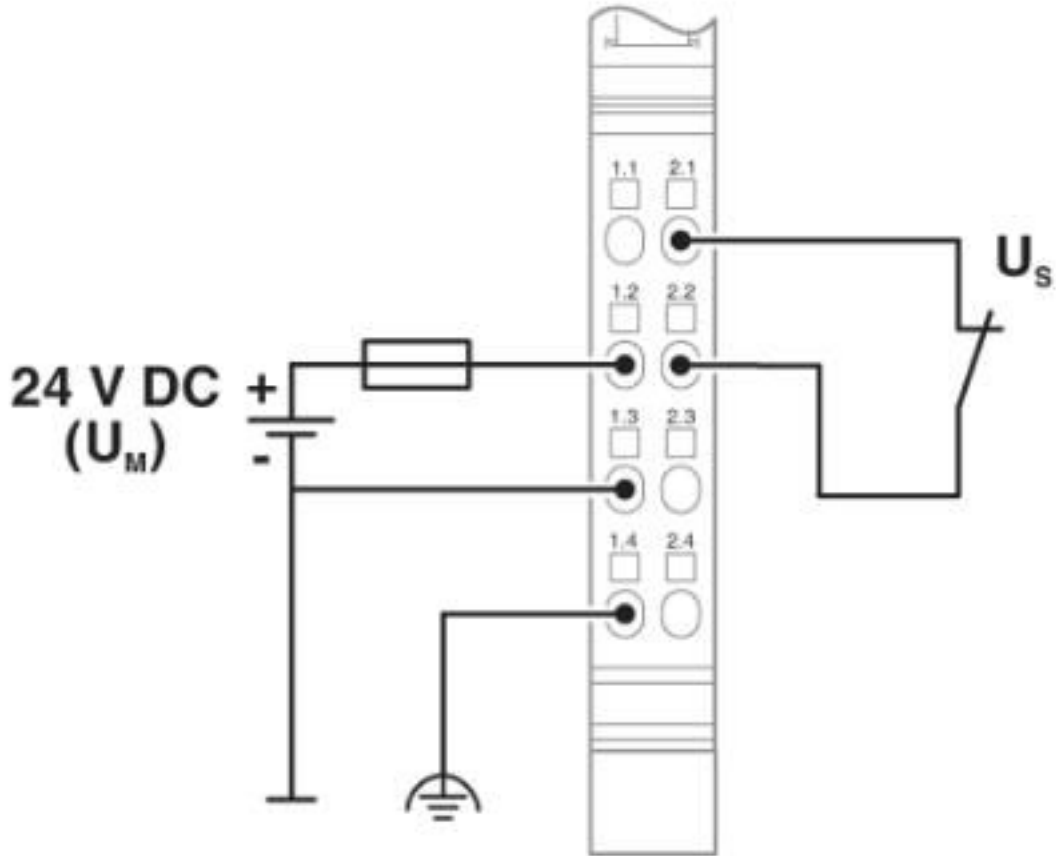

# Inline terminal - IB IL 24 PWR IN-PAC - 2861331

Dimensional drawing

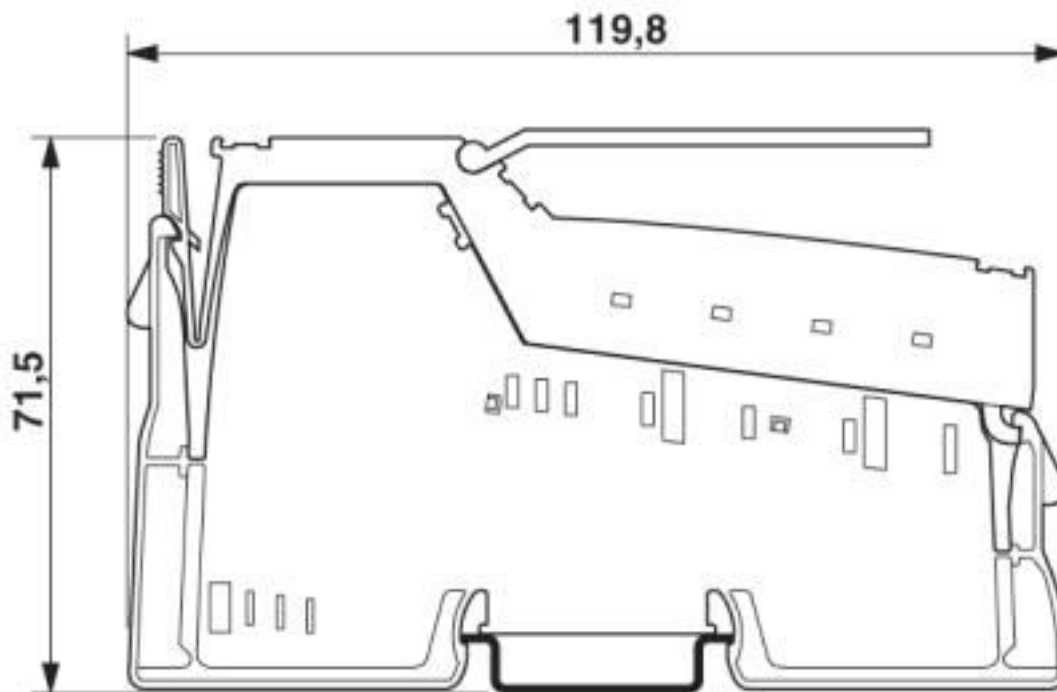

## Classifications

### eCl@ss

eCl@ss 10.0.1	27242610
eCl@ss 4.0	27250300
eCl@ss 4.1	27250300
eCl@ss 5.0	27250300
eCl@ss 5.1	27242600
eCl@ss 6.0	27242600
eCl@ss 7.0	27242610
eCl@ss 8.0	27242610
eCl@ss 9.0	27242610

### ETIM

ETIM 2.0	EC001433
ETIM 3.0	EC001600
ETIM 4.0	EC001600
ETIM 5.0	EC001600
ETIM 6.0	EC001600
ETIM 7.0	EC001600

### UNSPSC

UNSPSC 6.01	43172015
-------------	----------

# Inline terminal - IB IL 24 PWR IN-PAC - 2861331

## Classifications

### UNSPSC

UNSPSC 7.0901	43201404
UNSPSC 11	43172015
UNSPSC 12.01	43201404
UNSPSC 13.2	32151602
UNSPSC 18.0	32151602
UNSPSC 19.0	32151602
UNSPSC 20.0	32151602
UNSPSC 21.0	32151602

## Approvals

### Approvals



#### Approvals

DNV GL / BSH / BV / LR / ABS / BSH / RINA / UL Recognized / EAC

#### Ex Approvals

UL Listed / cUL Listed / ATEX / cULus Listed

### Approval details

DNV GL		<a href="https://approvalfinder.dnvgl.com/">https://approvalfinder.dnvgl.com/</a>	TAA00000BN
BSH			Anwenderhinweis
BV		<a href="http://www.veristar.com/portal/veristarinfo/generalinfo/approved/approvedProducts/equipmentAndMaterials">http://www.veristar.com/portal/veristarinfo/generalinfo/approved/approvedProducts/equipmentAndMaterials</a>	21595/B0 BV
LR		<a href="http://www.lr.org/en">http://www.lr.org/en</a>	08/20033
ABS		<a href="http://www.eagle.org/eagleExternalPortalWEB/">http://www.eagle.org/eagleExternalPortalWEB/</a>	17-HG1621871-PDA
BSH			658

# Inline terminal - IB IL 24 PWR IN-PAC - 2861331

## Approvals

RINA		<a href="http://www.rina.org/en">http://www.rina.org/en</a>	ELE001320XG
------	---	---	-------------

UL Recognized		<a href="http://database.ul.com/cgi-bin/XYV/template/LISEXT/1FRAME/index.htm">http://database.ul.com/cgi-bin/XYV/template/LISEXT/1FRAME/index.htm</a>	FILE E 140324
---------------	---	---	---------------

EAC			EAC-Zulassung
-----	---	--	---------------

## Accessories

### Accessories

#### Labeling panel

Labeling field - IB IL FIELD 2 - 2727501

Labeling field, width: 12.2 mm



### Plug

Inline connector - IB IL SCN-PWR IN-CP - 2727637



Connector, colored, for Inline power and segment terminal blocks

Inline connector - IB IL SCN-PWR IN - 2727462



Connector, for Inline power and segment terminal blocks

### Terminal marking

## Inline terminal - IB IL 24 PWR IN-PAC - 2861331

### Accessories

Insert strip - ESL 62X10 - 0809492



Insert strip, Sheet, white, unlabeled, can be labeled with: Office printing systems: Laser printer, mounting type: insert, lettering field size: 62 x 10 mm, Number of individual labels: 72

---

Phoenix Contact 2020 © - all rights reserved  
<http://www.phoenixcontact.com>

PHOENIX CONTACT GmbH & Co. KG  
Flachsmarktstr. 8  
32825 Blomberg  
Germany  
Tel. +49 5235 300  
Fax +49 5235 3 41200  
<http://www.phoenixcontact.com>



## X-ON Electronics

Largest Supplier of Electrical and Electronic Components

*Click to view similar products for [Controllers](#) category:*

*Click to view products by [Phoenix Contact](#) manufacturer:*

Other Similar products are found below :

[61FGPN8DAC120](#) [CV500SLK21](#) [70177-1011](#) [F03-03 HAS C](#) [F03-31](#) [81550401](#) [FT1A-C12RA-W](#) [88981106](#) [H2CAC24A](#) [H2CRSAC110B](#)  
[R88A-CRGB003CR-E](#) [R88ARR080100S](#) [R88A-TK01K](#) [DCN1-1](#) [DRT2ID08C](#) [DTB4896VRE](#) [DTB9696CVE](#) [DTB9696LVE](#) [E53-AZ01](#)  
[E53E01](#) [E53E8C](#) [E5C4Q40J999FAC120](#) [E5CWLQ1TCAC100240](#) [E5GNQ03PFLKACDC24](#) [B300LKL21](#) [NSCXDC1V3](#) [NSH5-232CW-3M](#)  
[NT20SST122BV1](#) [NV-CN001](#) [OAS-160-N](#) [C40PEDRA](#) [K31S6](#) [K33-L1B](#) [K3MA-F](#) [100-240VAC](#) [K3TX-AD31A](#) [89750101](#) [L595020](#)  
[SRM1-C02](#) [SRS2-1](#) [FT1A-C14SA-S](#) [G32X-V2K](#) [26546803](#) [26546805](#) [PWRA440A](#) [CPM1AETL03CH](#) [CV500SLK11](#) [3G2A5BI081](#)  
[3G2A5IA122](#) [3G2A5LK010E](#) [3G2A5OA223](#)