

Relay Module - PLC-RPT- 48DC/21HC - 2900294

Please be informed that the data shown in this PDF Document is generated from our Online Catalog. Please find the complete data in the user's documentation. Our General Terms of Use for Downloads are valid (<http://phoenixcontact.com/download>)



PLC-INTERFACE for high continuous currents, consisting of PLC-BPT.../21 HC basic terminal block with push-in connection and plug-in miniature relay, for mounting on DIN rail NS 35/7,5, limiting continuous current up to 10 A, 1 PDT, input voltage 48 V DC

Your advantages

- ✓ All common input voltages of 12 V DC to 230 V AC
- ✓ Long electrical service life thanks to 16 A relay
- ✓ Efficient connection to system cabling using V8 adapter
- ✓ Safe isolation according to DIN EN 50178 between coil and contact
- ✓ Max. continuous current of 10 A
- ✓ Functional plug-in bridges



Key Commercial Data

| | |
|--------------|---------------------------------------------------------------------------------------------------------|
| Packing unit | 10 pc |
| GTIN |  4 046356 509886 |
| GTIN | 4046356509886 |

Technical data

Note

| | |
|-------------------------|---------------------------------------------------------------------------|
| Utilization restriction | EMC: class A product, see manufacturer's declaration in the download area |
|-------------------------|---------------------------------------------------------------------------|

Dimensions

| | |
|--------|-------|
| Width | 14 mm |
| Height | 80 mm |
| Depth | 94 mm |

Ambient conditions

| | |
|-----------------------------------------|------------------|
| Ambient temperature (operation) | -40 °C ... 60 °C |
| Ambient temperature (storage/transport) | -40 °C ... 85 °C |
| Degree of protection | RT II (Relay) |

Relay Module - PLC-RPT- 48DC/21HC - 2900294

Technical data

Ambient conditions

| | |
|--|-------------------|
| | IP20 (Relay base) |
|--|-------------------|

Coil side

| | |
|-----------------------------------------|-------------------------------------------------------|
| Nominal input voltage U_N | 48 V DC |
| Typical input current at U_N | 20 mA |
| Typical response time | 8 ms |
| Typical release time | 10 ms |
| Protective circuit | Reverse polarity protection Polarity protection diode |
| | Free-wheeling diode Damping diode |
| Operating voltage display | Yellow LED |
| Power dissipation for nominal condition | 0.96 W |

Contact side

| | |
|-----------------------------------------------|-----------------------------------------------------------------------------------------------------------------------------------------------------------------------------------------------------------------------------------------------|
| Contact type | 1 PDT |
| Type of switch contact | Single contact |
| Contact material | AgNi |
| Maximum switching voltage | 250 V AC/DC (The separating plate PLC-ATP should be installed for voltages larger than 250 V (L1, L2, L3) between identical terminal blocks in adjacent modules. Potential bridging is then carried out with FBST 8-PLC... or ...FBST 500...) |
| Minimum switching voltage | 12 V DC (at 10 mA) |
| Min. switching current | 10 mA (at 12 V) |
| Maximum inrush current | 30 A (300 ms) |
| Limiting continuous current | 10 A |
| | 6 A (value applies to connections 12. If connections 12 are bridged, the normal value applies.) |
| Interrupting rating (ohmic load) max. | 240 W (at 24 V DC) |
| | 58 W (at 48 V DC) |
| | 48 W (at 60 V DC) |
| | 50 W (at 110 V DC) |
| | 80 W (at 220 V DC) |
| | 2500 VA (for 250 V AC) |
| Interrupting rating (ohmic load) max. bridged | 144 W (for 24 V DC. Value applies to connections 12. If connections 12 are bridged, the normal value applies.) |
| | 1500 VA (for 250 V AC. Value applies to connections 12. If connections 12 are bridged, the normal value applies.) |
| Switching capacity | 2 A (at 24 V, DC13) |
| | 0.2 A (at 110 V, DC13) |
| | 0.2 A (at 250 V, DC13) |
| | 6 A (at 24 V, AC15) |
| | 6 A (at 120 V, AC15) |
| | 6 A (at 250 V, AC15) |

General

Relay Module - PLC-RPT- 48DC/21HC - 2900294

Technical data

General

| | |
|----------------------------------------|---------------------------|
| Operating mode | 100% operating factor |
| Flammability rating according to UL 94 | V0 (Housing) |
| Mechanical service life | 3x 10 ⁷ cycles |
| Mounting position | any |
| Assembly instructions | In rows with zero spacing |

Connection data

| | |
|----------------------------------|--------------------------------------------------------------|
| Connection name | Coil side |
| Connection method | Push-in connection |
| Stripping length | 8 mm |
| Conductor cross section solid | 0.14 mm ² ... 2.5 mm ² |
| Conductor cross section flexible | 0.14 mm ² ... 2.5 mm ² |
| | 0.2 mm ² ... 2.5 mm ² (Single ferrule) |
| | 2x 0.5 mm ² ... 1 mm ² (TWIN ferrule) |
| Conductor cross section AWG | 26 ... 14 |

Connection data 2

| | |
|----------------------------------|--------------------------------------------------------------|
| Connection name | Contact side |
| Connection method | Push-in connection |
| Stripping length | 8 mm |
| Conductor cross section solid | 0.14 mm ² ... 2.5 mm ² |
| Conductor cross section flexible | 0.14 mm ² ... 2.5 mm ² |
| | 0.2 mm ² ... 2.5 mm ² (Single ferrule) |
| | 2x 0.5 mm ² ... 1 mm ² (TWIN ferrule) |
| Conductor cross section AWG | 26 ... 14 |

Standards and Regulations

| | |
|----------------------------------|---------------------------------------|
| Connection in acc. with standard | CUL |
| Designation | Standards/regulations |
| Standards/regulations | IEC 60664 |
| | EN 50178 |
| Rated surge voltage | 6 kV |
| Insulation | Safe isolation, reinforced insulation |
| Pollution degree | 2 |
| Overvoltage category | III |

Environmental Product Compliance

| | |
|------------|-----------------------------------------------------------------------------------------------------|
| China RoHS | Environmentally Friendly Use Period = 50 years |
| | For details about hazardous substances go to tab "Downloads", Category "Manufacturer's declaration" |

Drawings

Relay Module - PLC-RPT- 48DC/21HC - 2900294

Diagram

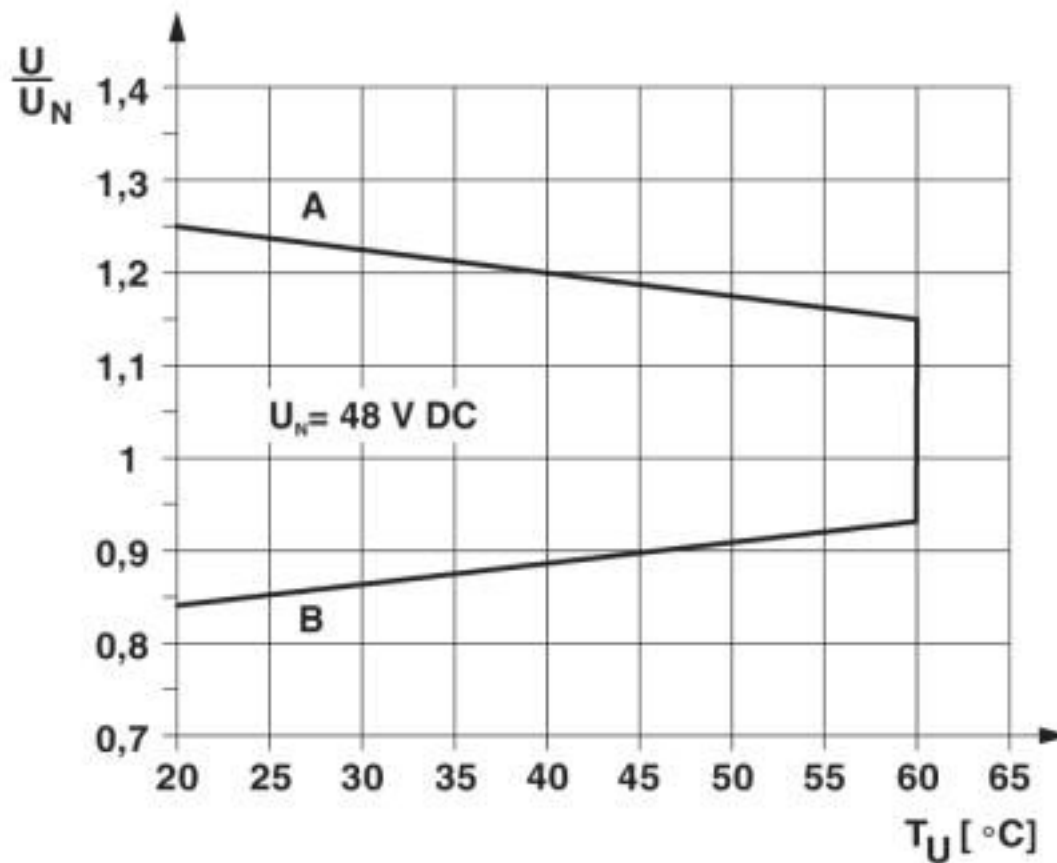

Curve A
Maximum permissible continuous voltage U_{max} with limiting continuous current on the contact side (see relevant technical data)
Curve B
Minimum permissible operate voltage U_{op} after pre-excitation (see relevant technical data)

Relay Module - PLC-RPT- 48DC/21HC - 2900294

Diagram

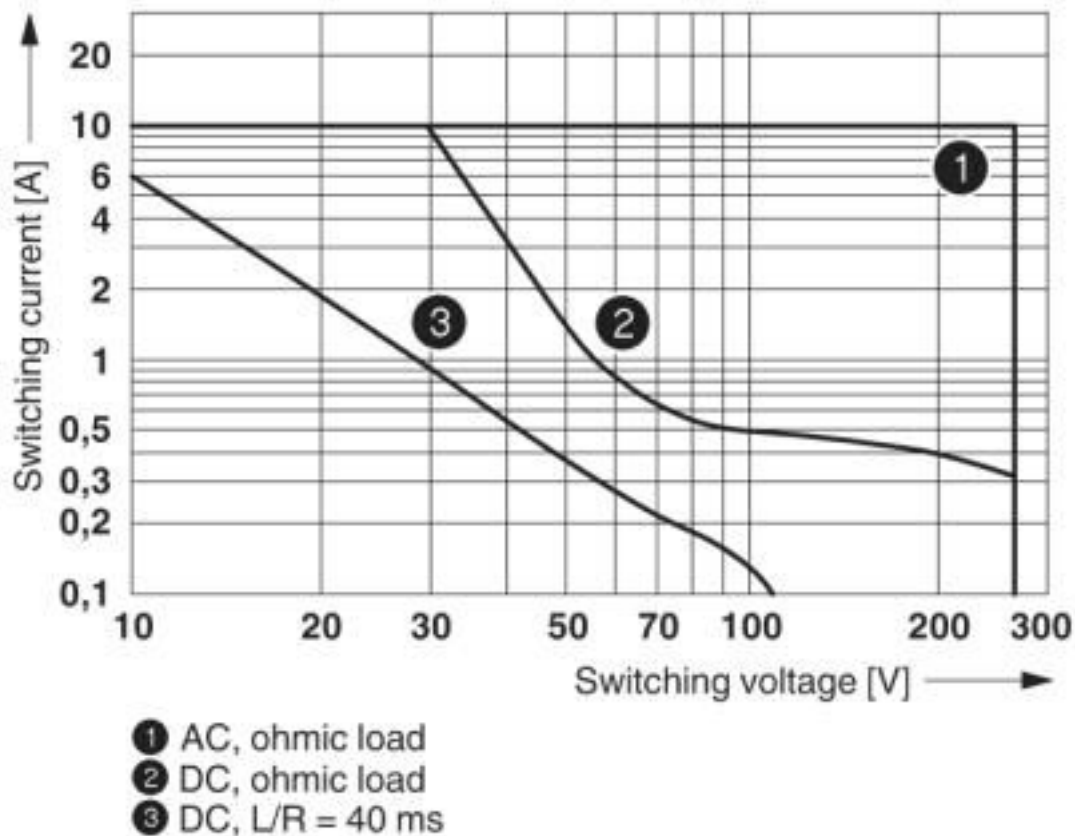

Interrupting rating

Circuit diagram

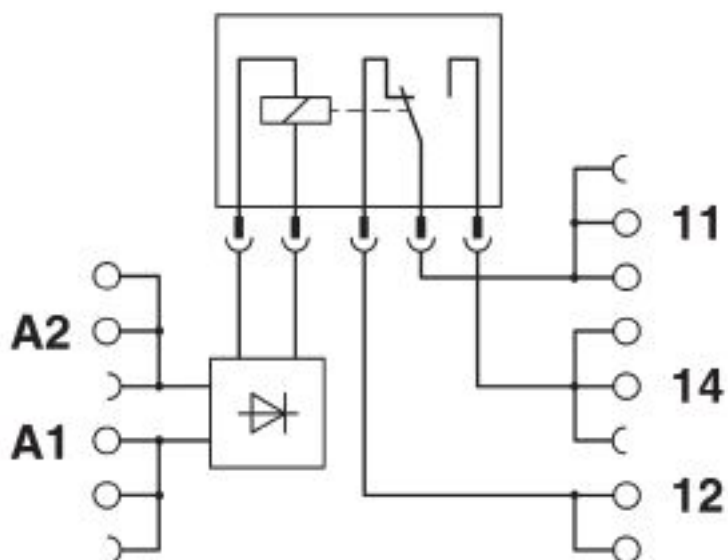

Relay Module - PLC-RPT- 48DC/21HC - 2900294

Articles in set

Relay base - PLC-BPT- 48DC/21HC - 2900256



14 mm PLC basic terminal block for high continuous currents with push-in connection, without relay or solid-state relay, for mounting on DIN rail NS 35/7,5, 1 PDT, input voltage 48 V DC

Single relay - REL-MR- 24DC/21HC - 2961312



Plug-in miniature power relay, with power contact for high continuous currents, 1 PDT, input voltage 24 V DC

Classifications

eCl@ss

| | |
|---------------|----------|
| eCl@ss 10.0.1 | 27371601 |
| eCl@ss 4.0 | 27371000 |
| eCl@ss 4.1 | 27371000 |
| eCl@ss 5.0 | 27371600 |
| eCl@ss 5.1 | 27371600 |
| eCl@ss 6.0 | 27371600 |
| eCl@ss 7.0 | 27371601 |
| eCl@ss 8.0 | 27371601 |
| eCl@ss 9.0 | 27371601 |

ETIM

| | |
|----------|----------|
| ETIM 2.0 | EC001437 |
| ETIM 3.0 | EC001437 |
| ETIM 4.0 | EC001437 |
| ETIM 5.0 | EC001437 |
| ETIM 6.0 | EC001437 |
| ETIM 7.0 | EC001437 |

UNSPSC

| | |
|---------------|----------|
| UNSPSC 6.01 | 30211916 |
| UNSPSC 7.0901 | 39121515 |
| UNSPSC 11 | 39121515 |
| UNSPSC 12.01 | 39121515 |
| UNSPSC 13.2 | 39122334 |

Relay Module - PLC-RPT- 48DC/21HC - 2900294

Classifications

UNSPSC

| | |
|-------------|----------|
| UNSPSC 18.0 | 39122334 |
| UNSPSC 19.0 | 39122334 |
| UNSPSC 20.0 | 39122334 |
| UNSPSC 21.0 | 39122334 |

Approvals

Approvals

Approvals

UL Listed / UL Recognized / cUL Recognized / cUL Listed / RC FRT / EAC / cULus Recognized / cULus Listed

Ex Approvals

Approval details

| | | | |
|-----------|-------------------------------------------------------------------------------------|-------------------------------------------------------------------------------------------------------------------------------------------------------|---------------|
| UL Listed |  | http://database.ul.com/cgi-bin/XYV/template/LISEXT/1FRAME/index.htm | FILE E 172140 |
|-----------|-------------------------------------------------------------------------------------|-------------------------------------------------------------------------------------------------------------------------------------------------------|---------------|

| | | | |
|---------------|-------------------------------------------------------------------------------------|-------------------------------------------------------------------------------------------------------------------------------------------------------|---------------|
| UL Recognized |  | http://database.ul.com/cgi-bin/XYV/template/LISEXT/1FRAME/index.htm | FILE E 238705 |
|---------------|-------------------------------------------------------------------------------------|-------------------------------------------------------------------------------------------------------------------------------------------------------|---------------|

| | | | |
|----------------|-------------------------------------------------------------------------------------|-------------------------------------------------------------------------------------------------------------------------------------------------------|---------------|
| cUL Recognized |  | http://database.ul.com/cgi-bin/XYV/template/LISEXT/1FRAME/index.htm | FILE E 238705 |
|----------------|-------------------------------------------------------------------------------------|-------------------------------------------------------------------------------------------------------------------------------------------------------|---------------|

| | | | |
|------------|-------------------------------------------------------------------------------------|-------------------------------------------------------------------------------------------------------------------------------------------------------|---------------|
| cUL Listed |  | http://database.ul.com/cgi-bin/XYV/template/LISEXT/1FRAME/index.htm | FILE E 172140 |
|------------|-------------------------------------------------------------------------------------|-------------------------------------------------------------------------------------------------------------------------------------------------------|---------------|

| | | | |
|--------|-------------------------------------------------------------------------------------|--|---------|
| RC FRT |  | | B.00094 |
|--------|-------------------------------------------------------------------------------------|--|---------|

| | | | |
|-----|-------------------------------------------------------------------------------------|--|-----------------|
| EAC |  | | TR_TS_D_00573_c |
|-----|-------------------------------------------------------------------------------------|--|-----------------|

Relay Module - PLC-RPT- 48DC/21HC - 2900294

Approvals

cULus Recognized



cULus Listed



Accessories

Accessories

Bridge

Continuous plug-in bridge - FBST 500-PLC RD - 2966786



Continuous plug-in bridge, length: 500 mm, color: red

Continuous plug-in bridge - FBST 500-PLC BU - 2966692



Continuous plug-in bridge, length: 500 mm, color: blue

Continuous plug-in bridge - FBST 500-PLC GY - 2966838



Continuous plug-in bridge, length: 500 mm, color: gray

Single plug-in bridge - FBST 6-PLC RD - 2966236



Single plug-in bridge, length: 6 mm, number of positions: 2, color: red

Relay Module - PLC-RPT- 48DC/21HC - 2900294

Accessories

Single plug-in bridge - FBST 6-PLC BU - 2966812



Single plug-in bridge, length: 6 mm, number of positions: 2, color: blue

Single plug-in bridge - FBST 6-PLC GY - 2966825



Single plug-in bridge, length: 6 mm, number of positions: 2, color: gray

Single plug-in bridge - FBST 8-PLC GY - 2967688



Single plug-in bridge, length: 8 mm, number of positions: 2, color: gray

Single plug-in bridge - FBST 14-PLC BK - 2967691



Single plug-in bridge, length: 14 mm, number of positions: 2, color: black

DIN rail

DIN rail perforated - NS 35/ 7,5 PERF 2000MM - 0801733



DIN rail perforated, Standard profile, width: 35 mm, height: 7.5 mm, acc. to EN 60715, material: Steel, galvanized, passivated with a thick layer, length: 2000 mm, color: silver

Relay Module - PLC-RPT- 48DC/21HC - 2900294

Accessories

DIN rail, unperforated - NS 35/ 7,5 UNPERF 2000MM - 0801681



DIN rail, unperforated, Standard profile, width: 35 mm, height: 7.5 mm, acc. to EN 60715, material: Steel, galvanized, passivated with a thick layer, length: 2000 mm, color: silver

DIN rail perforated - NS 35/ 7,5 WH PERF 2000MM - 1204119



DIN rail perforated, Standard profile, width: 35 mm, height: 7.5 mm, acc. to EN 60715, material: Steel, Galvanized, white passivated, length: 2000 mm, color: silver

DIN rail, unperforated - NS 35/ 7,5 WH UNPERF 2000MM - 1204122



DIN rail, unperforated, Standard profile, width: 35 mm, height: 7.5 mm, acc. to EN 60715, material: Steel, Galvanized, white passivated, length: 2000 mm, color: silver

DIN rail, unperforated - NS 35/ 7,5 AL UNPERF 2000MM - 0801704



DIN rail, unperforated, Standard profile, width: 35 mm, height: 7.5 mm, acc. to EN 60715, material: Aluminum, uncoated, length: 2000 mm, color: silver

DIN rail perforated - NS 35/ 7,5 ZN PERF 2000MM - 1206421



DIN rail perforated, Standard profile, width: 35 mm, height: 7.5 mm, acc. to EN 60715, material: Steel, galvanized, length: 2000 mm, color: silver

Relay Module - PLC-RPT- 48DC/21HC - 2900294

Accessories

DIN rail, unperforated - NS 35/ 7,5 ZN UNPERF 2000MM - 1206434



DIN rail, unperforated, Standard profile, width: 35 mm, height: 7.5 mm, acc. to EN 60715, material: Steel, galvanized, length: 2000 mm, color: silver

DIN rail, unperforated - NS 35/ 7,5 CU UNPERF 2000MM - 0801762



DIN rail, unperforated, Standard profile, width: 35 mm, height: 7.5 mm, acc. to EN 60715, material: Copper, uncoated, length: 2000 mm, color: copper-colored

End cap - NS 35/ 7,5 CAP - 1206560



DIN rail end piece, for DIN rail NS 35/7.5

DIN rail perforated - NS 35/15 PERF 2000MM - 1201730



DIN rail perforated, Standard profile, width: 35 mm, height: 15 mm, similar to EN 60715, material: Steel, galvanized, passivated with a thick layer, length: 2000 mm, color: silver

DIN rail, unperforated - NS 35/15 UNPERF 2000MM - 1201714

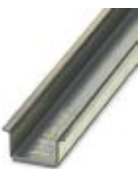

DIN rail, unperforated, Standard profile, width: 35 mm, height: 15 mm, similar to EN 60715, material: Steel, galvanized, passivated with a thick layer, length: 2000 mm, color: silver

Relay Module - PLC-RPT- 48DC/21HC - 2900294

Accessories

DIN rail perforated - NS 35/15 WH PERF 2000MM - 0806602



DIN rail perforated, Standard profile, width: 35 mm, height: 15 mm, similar to EN 60715, material: Steel, Galvanized, white passivated, length: 2000 mm, color: silver

DIN rail, unperforated - NS 35/15 WH UNPERF 2000MM - 1204135



DIN rail, unperforated, Standard profile, width: 35 mm, height: 15 mm, similar to EN 60715, material: Steel, Galvanized, white passivated, length: 2000 mm, color: silver

DIN rail, unperforated - NS 35/15 AL UNPERF 2000MM - 1201756



DIN rail, unperforated, Standard profile, width: 35 mm, height: 15 mm, similar to EN 60715, material: Aluminum, uncoated, length: 2000 mm, color: silver

DIN rail perforated - NS 35/15 ZN PERF 2000MM - 1206599



DIN rail perforated, Standard profile, width: 35 mm, height: 15 mm, similar to EN 60715, material: Steel, galvanized, length: 2000 mm, color: silver

DIN rail, unperforated - NS 35/15 ZN UNPERF 2000MM - 1206586



DIN rail, unperforated, Standard profile, width: 35 mm, height: 15 mm, similar to EN 60715, material: Steel, galvanized, length: 2000 mm, color: silver

Relay Module - PLC-RPT- 48DC/21HC - 2900294

Accessories

DIN rail, unperforated - NS 35/15 CU UNPERF 2000MM - 1201895



DIN rail, unperforated, Standard profile, width: 35 mm, height: 15 mm, similar to EN 60715, material: Copper, uncoated, length: 2000 mm, color: copper-colored

End cap - NS 35/15 CAP - 1206573



DIN rail end piece, for DIN rail NS 35/15

DIN rail, unperforated - NS 35/15-2,3 UNPERF 2000MM - 1201798



DIN rail, unperforated, Standard profile 2.3 mm, width: 35 mm, height: 15 mm, acc. to EN 60715, material: Steel, galvanized, passivated with a thick layer, length: 2000 mm, color: silver

Labeled terminal marker

Zack marker strip - ZB 10 CUS - 0824941



Zack marker strip, can be ordered: Strip, white, labeled according to customer specifications, mounting type: snap into tall marker groove, for terminal block width: 10.2 mm, lettering field size: 10.15 x 10.5 mm, Number of individual labels: 10

Zack marker strip - ZB10,LGS:FORTL.ZAHLEN - 1053014



Zack marker strip, Strip, white, labeled, can be labeled with: CMS-P1-PLOTTER, printed horizontally: consecutive numbers 1 ... 10, 11 ... 20, etc. up to 91 ... 100, mounting type: snap into tall marker groove, for terminal block width: 10.2 mm, lettering field size: 10.15 x 10.5 mm, Number of individual labels: 10

Relay Module - PLC-RPT- 48DC/21HC - 2900294

Accessories

Zack marker strip - ZB10,QR:FORTL.ZAHLEN - 1053027



Zack marker strip, Strip, white, labeled, can be labeled with: CMS-P1-PLOTTER, Printed vertically: consecutive numbers 1 ... 10, 11 ... 20, etc. up to 91 ... 100, mounting type: snap into tall marker groove, for terminal block width: 10.2 mm, lettering field size: 10.15 x 10.5 mm, Number of individual labels: 10

Marker for terminal blocks - ZB10,LGS:L1-N,PE - 1053412



Marker for terminal blocks, Strip, white, labeled, can be labeled with: CMS-P1-PLOTTER, horizontal: L1, L2, L3, N, PE, L1, L2, L3, N, PE, mounting type: snap into tall marker groove, for terminal block width: 10.2 mm, lettering field size: 10.15 x 10.5 mm, Number of individual labels: 10

Marker for terminal blocks - ZB10,LGS:U-N - 1053438



Marker for terminal blocks, Strip, white, labeled, can be labeled with: CMS-P1-PLOTTER, horizontal: U, V, W, N, GND, U, V, W, N, GND, mounting type: snap into tall marker groove, for terminal block width: 10.2 mm, lettering field size: 10.15 x 10.5 mm, Number of individual labels: 10

Marker for terminal blocks - UC-TM 10 CUS - 0824605



Marker for terminal blocks, can be ordered: by sheet, white, labeled according to customer specifications, mounting type: snap into tall marker groove, for terminal block width: 10.2 mm, lettering field size: 9.6 x 10.5 mm, Number of individual labels: 48

Marker for terminal blocks - UCT-TM 10 CUS - 0829623



Marker for terminal blocks, can be ordered: by sheet, white, labeled according to customer specifications, mounting type: snap into tall marker groove, for terminal block width: 10.2 mm, lettering field size: 8.9 x 9.6 mm, Number of individual labels: 36

Relay Module - PLC-RPT- 48DC/21HC - 2900294

Accessories

Zack marker strip - ZB 12 CUS - 0824942



Zack marker strip, can be ordered: Strip, white, labeled according to customer specifications, mounting type: snap into tall marker groove, for terminal block width: 12.2 mm, lettering field size: 10.5 x 12.15 mm, Number of individual labels: 5

Zack marker strip - ZB 12,LGS:L1-N,PE - 0812146



Zack marker strip, Strip, white, labeled, printed horizontally: L1, L2, L3, N, PE, mounting type: snap into tall marker groove, for terminal block width: 12.2 mm, lettering field size: 10.5 x 12.15 mm, Number of individual labels: 5

Marker for terminal blocks - UC-TM 12 CUS - 0824613



Marker for terminal blocks, can be ordered: by sheet, white, labeled according to customer specifications, mounting type: snap into tall marker groove, for terminal block width: 12 mm, lettering field size: 11.45 x 10.5 mm, Number of individual labels: 40

Marker for terminal blocks - UCT-TM 12 CUS - 0829630



Marker for terminal blocks, can be ordered: by sheet, white, labeled according to customer specifications, mounting type: snap into tall marker groove, for terminal block width: 12 mm, lettering field size: 10.8 x 9.6 mm, Number of individual labels: 30

Partition plate

Separating plate - PLC-ATP BK - 2966841



Separating plate, 2 mm thick, required at the start and end of a PLC terminal strip. Furthermore, it is used for: visual separation of groups, safe isolation of different voltages of neighboring PLC relays in acc. with DIN VDE 0106-101, isolation

Power module

Relay Module - PLC-RPT- 48DC/21HC - 2900294

Accessories

Power terminal block - PLC-ESK GY - 2966508



Power terminal block, for the input of up to four potentials, for mounting on NS 35/7.5

Screwdriver tools

Screwdriver - SZF 1-0,6X3,5 - 1204517



Actuation tool, for ST terminal blocks, also suitable for use as a bladed screwdriver, size: 0.6 x 3.5 x 100 mm, 2-component grip, with non-slip grip

Terminal marking

Zack marker strip - ZB 10:UNBEDRUCKT - 1053001



Zack marker strip, Strip, white, unlabeled, can be labeled with: PLOTMARK, CMS-P1-PLOTTER, mounting type: snap into tall marker groove, for terminal block width: 10.2 mm, lettering field size: 10.5 x 10.15 mm, Number of individual labels: 10

Marker for terminal blocks - UC-TM 10 - 0818069



Marker for terminal blocks, Sheet, white, unlabeled, can be labeled with: BLUEMARK ID COLOR, BLUEMARK ID, BLUEMARK CLED, PLOTMARK, CMS-P1-PLOTTER, mounting type: snap into tall marker groove, for terminal block width: 10.2 mm, lettering field size: 9.6 x 10.5 mm, Number of individual labels: 48

Marker for terminal blocks - UCT-TM 10 - 0829142



Marker for terminal blocks, Sheet, white, unlabeled, can be labeled with: TOPMARK NEO, TOPMARK LASER, BLUEMARK ID COLOR, BLUEMARK ID, BLUEMARK CLED, THERMOMARK PRIME, THERMOMARK CARD 2.0, THERMOMARK CARD, mounting type: snap into tall marker groove, for terminal block width: 10.2 mm, lettering field size: 8.9 x 9.6 mm, Number of individual labels: 36

Relay Module - PLC-RPT- 48DC/21HC - 2900294

Accessories

Zack marker strip - ZB 12:UNPRINTED - 0812120



Zack marker strip, Strip, white, unlabeled, can be labeled with: PLOTMARK, CMS-P1-PLOTTER, mounting type: snap into tall marker groove, for terminal block width: 12.2 mm, lettering field size: 12 x 10.5 mm, Number of individual labels: 5

Marker for terminal blocks - UC-TM 12 - 0819194



Marker for terminal blocks, Sheet, white, unlabeled, can be labeled with: BLUEMARK ID COLOR, BLUEMARK ID, BLUEMARK CLED, PLOTMARK, CMS-P1-PLOTTER, mounting type: snap into tall marker groove, for terminal block width: 12 mm, lettering field size: 11.45 x 10.5 mm, Number of individual labels: 40

Marker for terminal blocks - UCT-TM 12 - 0829144



Marker for terminal blocks, Sheet, white, unlabeled, can be labeled with: TOPMARK NEO, TOPMARK LASER, BLUEMARK ID COLOR, BLUEMARK ID, BLUEMARK CLED, THERMOMARK PRIME, THERMOMARK CARD 2.0, THERMOMARK CARD, mounting type: snap into tall marker groove, for terminal block width: 12 mm, lettering field size: 10.8 x 9.6 mm, Number of individual labels: 30

Spare parts

Relay base - PLC-BPT- 48DC/21HC - 2900256



14 mm PLC basic terminal block for high continuous currents with push-in connection, without relay or solid-state relay, for mounting on DIN rail NS 35/7,5, 1 PDT, input voltage 48 V DC

Single relay - REL-MR- 24DC/21HC - 2961312



Plug-in miniature power relay, with power contact for high continuous currents, 1 PDT, input voltage 24 V DC

Phoenix Contact 2020 © - all rights reserved
<http://www.phoenixcontact.com>

PHOENIX CONTACT GmbH & Co. KG
Flachsmarktstr. 8
32825 Blomberg
Germany
Tel. +49 5235 300
Fax +49 5235 3 41200
<http://www.phoenixcontact.com>

X-ON Electronics

Largest Supplier of Electrical and Electronic Components

Click to view similar products for [Industrial Relays](#) category:

Click to view products by [Phoenix Contact](#) manufacturer:

Other Similar products are found below :

[6-1617801-8](#) [6-1618107-9](#) [7-1618273-3](#) [EV250-4A-02](#) [EV250-6A-01](#) [FCA-125-CX8](#) [FCA-325-159](#) [FCA-410-138](#) [8000-S3121](#) [8-1618273-6](#)
[8-1618393-1](#) [GCA63A220VAC60HZ](#) [GCA63A277VAC60HZ](#) [GCA63A600VAC60HZ](#) [1-1672275-3](#) [1-1833005-4](#) [H-16/S1](#) [A711Z](#) [H-8C](#)
[H-8/S11](#) [H-8/S68](#) [ACC530U20](#) [ACC730U30](#) [RF303ZM4-12](#) [DH18DA](#) [1423675-8](#) [AR4-15F13-C01](#) [AR7-41F11](#) [AVR907](#) [15732A200](#)
[B07B032AC1-0329](#) [B329](#) [B490A](#) [1618279-1](#) [BHR124Y](#) [1810DDB-SX](#) [N417](#) [P30C42A12D1-120](#) [2-1617748-6](#) [2-1618375-1](#) [2-1618396-6](#)
[2-1618398-1](#) [JMAPD-5XL](#) [JMGACD-5M](#) [JMGSC-5LW](#) [JMGSCD-5L](#) [PBO-18A1218](#) [PBO-40A3040](#) [K8DSPH1200480VAC](#) [KA-3C-12A](#)