

# Relay Module - RIF-1-RPT-LV-120AC/2X21AU - 2903328

Please be informed that the data shown in this PDF Document is generated from our Online Catalog. Please find the complete data in the user's documentation. Our General Terms of Use for Downloads are valid (<http://phoenixcontact.com/download>)



Pre-assembled relay module with push-in connection, consisting of: relay base, multi-layer contact relay, plug-in display/suppressor module, and retaining bracket. Contact type: 2 PDTs. Input voltage: 120 V AC

## Product Description

The pluggable electromechanical and solid-state relays in the RIFLINE complete product range and the base are recognized and approved in accordance with UL 508.

The relevant approvals can be called up at the individual components in question.



## Key Commercial Data

Packing unit	10 pc
GTIN	
GTIN	4046356732321

## Technical data

### Note

Utilization restriction	EMC: class A product, see manufacturer's declaration in the download area
Type of note	Notes on operation
Note	FBS 2-6... plug-in bridge for the input side (A2) and FBS-2-8... plug-in bridge for the output side (11/21)

### Dimensions

Width	16 mm
Height	93 mm
Depth	75 mm

### Ambient conditions

Ambient temperature (operation)	-40 °C ... 50 °C
Ambient temperature (storage/transport)	-40 °C ... 85 °C
Degree of protection	IP20 (Relay base)
	RT III (Relay)

# Relay Module - RIF-1-RPT-LV-120AC/2X21AU - 2903328

## Technical data

### Coil side

Nominal input voltage $U_N$	120 V AC
Input voltage range in reference to $U_N$	see diagram
Mains frequency	50/60 Hz
Typical input current at $U_N$	8 mA
Typical response time	3 ms ... 12 ms
Typical release time range	3 ms ... 20 ms
Coil voltage	120 V AC
Protective circuit	Varistor
Operating voltage display	Yellow LED
Power dissipation for nominal condition	0.96 W

### Contact side

Contact type	2 PDT
Type of switch contact	Single contact
Contact material	AgNi, hard gold-plated
Maximum switching voltage	30 V AC 36 V DC
Minimum switching voltage	100 mV (at 10 mA)
Min. switching current	1 mA (at 24 V)
Maximum inrush current	50 mA
Limiting continuous current	50 mA
Interrupting rating (ohmic load) max.	1.2 W (at 24 V DC)

### Contact side (with destroyed gold layer)

Contact material	AgNi
Note	the following values are applicable if a gold layer is destroyed
Maximum switching voltage	250 V AC/DC
Minimum switching voltage	5 V (at 10 mA)
Limiting continuous current	12 A (20 ms, N/O contacts)
Min. switching current	10 mA (At 5 V)
Interrupting rating (ohmic load) max.	192 W (at 24 V DC) 96 W (at 48 V DC) 60 W (at 60 V DC) 44 W (at 110 V DC) 57 W (at 220 V DC) 2000 VA (for 250 V AC)
Switching capacity	2 A (at 24 V, DC13) 0.2 A (at 110 V, DC13) 0.2 A (at 250 V, DC13) 2 A (at 24 V, AC15) 2 A (at 120 V, AC15)

# Relay Module - RIF-1-RPT-LV-120AC/2X21AU - 2903328

## Technical data

Contact side (with destroyed gold layer)

	2 A (at 250 V, AC15)
--	----------------------

### General

Test voltage relay winding/relay contact	4 kV <sub>rms</sub> (50 Hz, 1 min.)
Test voltage PDT/PDT	2.5 kV <sub>rms</sub> (50 Hz, 1 min.)
Operating mode	100% operating factor
Flammability rating according to UL 94	V2 (Housing)
Mechanical service life	approx. 10 <sup>7</sup> cycles
Service life, electrical	see diagram
Mounting position	any
Assembly instructions	In rows with zero spacing

### Connection data

Connection name	Coil side
Connection method	Push-in connection
Stripping length	8 mm
Conductor cross section solid	0.14 mm <sup>2</sup> ... 1.5 mm <sup>2</sup>
Conductor cross section flexible	0.14 mm <sup>2</sup> ... 1.5 mm <sup>2</sup>
	0.14 mm <sup>2</sup> ... 1.5 mm <sup>2</sup> (Ferrule with plastic sleeve)
	0.14 mm <sup>2</sup> ... 1 mm <sup>2</sup> (Ferrule with plastic sleeve, two conductors on double terminal block)
Conductor cross section AWG	26 ... 16 (solid)
	26 ... 16 (flexible)

### Connection data 2

Connection name	Contact side
Connection method	Push-in connection
Stripping length	8 mm
Conductor cross section solid	0.14 mm <sup>2</sup> ... 1.5 mm <sup>2</sup>
Conductor cross section flexible	0.14 mm <sup>2</sup> ... 1.5 mm <sup>2</sup>
	0.14 mm <sup>2</sup> ... 1.5 mm <sup>2</sup> (Ferrule with plastic sleeve)
	0.14 mm <sup>2</sup> ... 1 mm <sup>2</sup> (Ferrule with plastic sleeve, two conductors on double terminal block)
Conductor cross section AWG	26 ... 16 (solid)
	26 ... 16 (flexible)

### Standards and Regulations

Standards/regulations	DIN EN 50178
Rated surge voltage	6 kV
Insulation	Safe isolation, basic insulation, and 4 kV rated surge voltage between all changeover contacts.
Pollution degree	2
Overvoltage category	III

# Relay Module - RIF-1-RPT-LV-120AC/2X21AU - 2903328

## Technical data

### Environmental Product Compliance

China RoHS	Environmentally Friendly Use Period = 50 years
	For details about hazardous substances go to tab "Downloads", Category "Manufacturer's declaration"

## Drawings

Circuit diagram

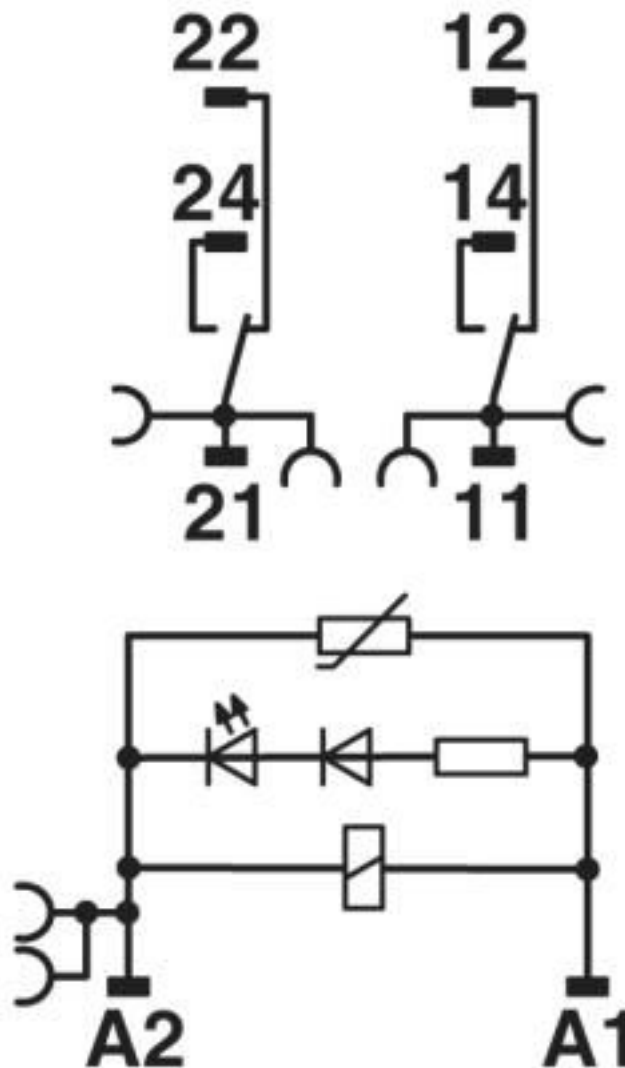

AC coils

# Relay Module - RIF-1-RPT-LV-120AC/2X21AU - 2903328

Diagram

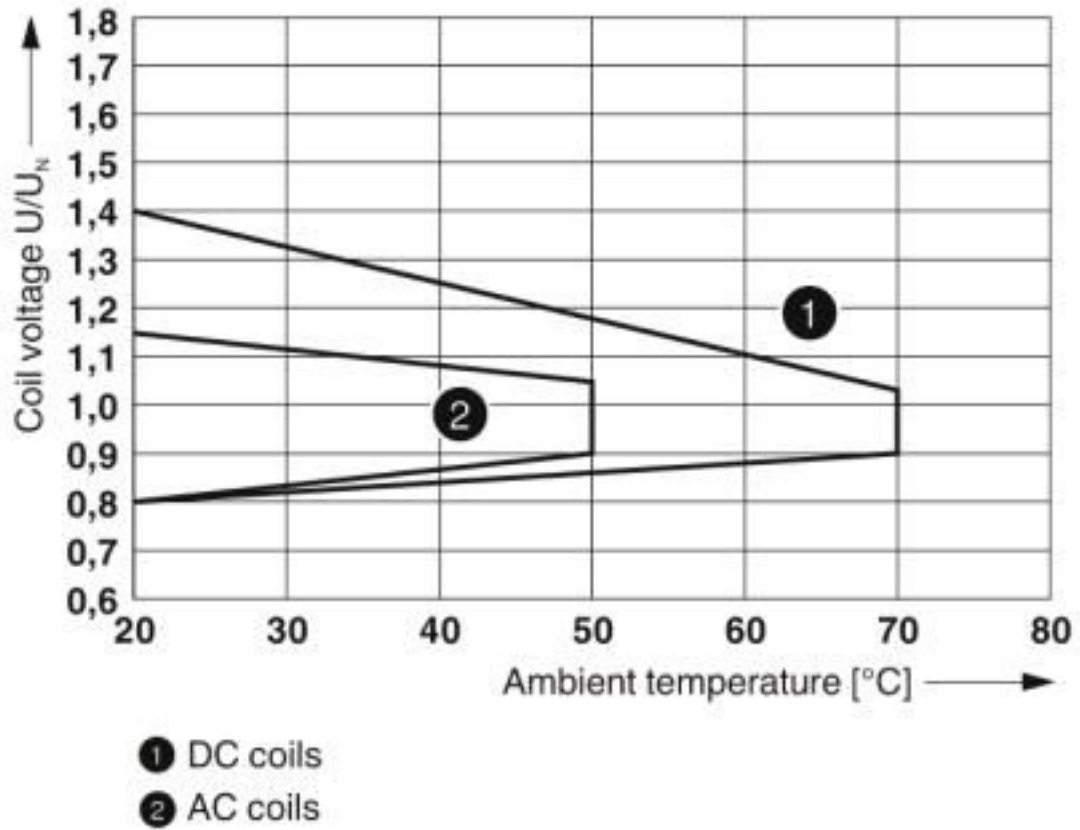

Operating voltage range

# Relay Module - RIF-1-RPT-LV-120AC/2X21AU - 2903328

Diagram

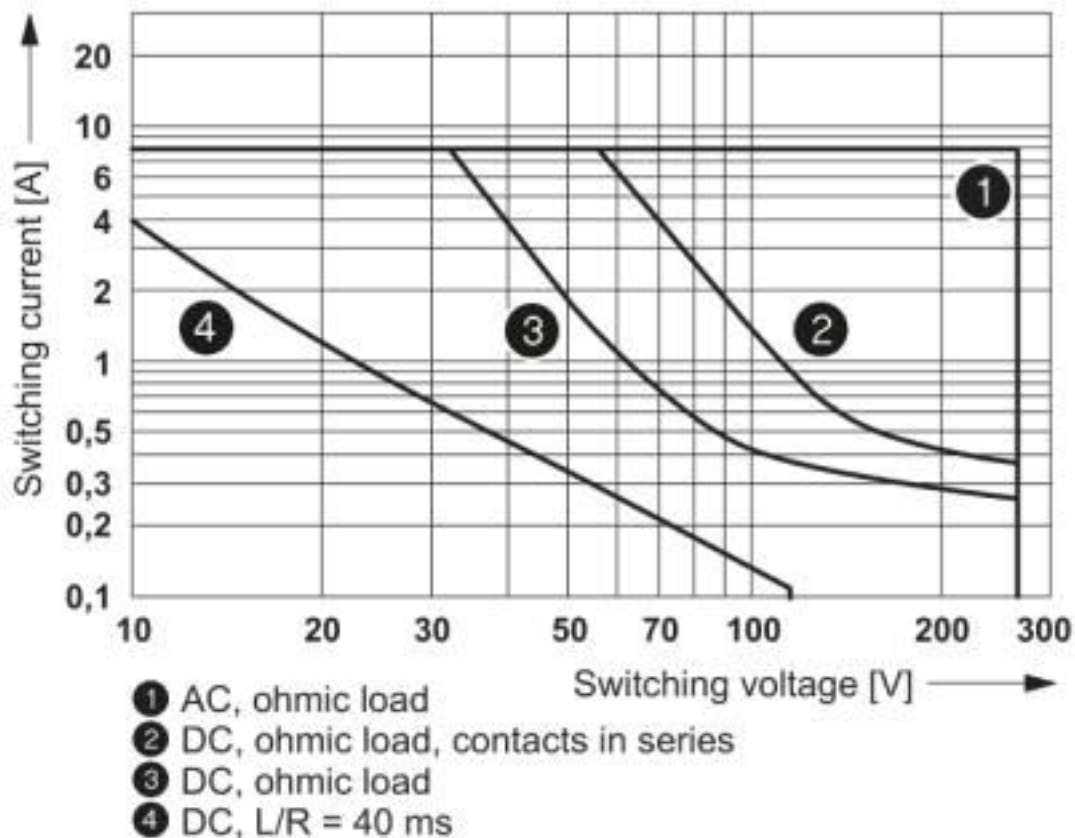

Interrupting rating

# Relay Module - RIF-1-RPT-LV-120AC/2X21AU - 2903328

Diagram

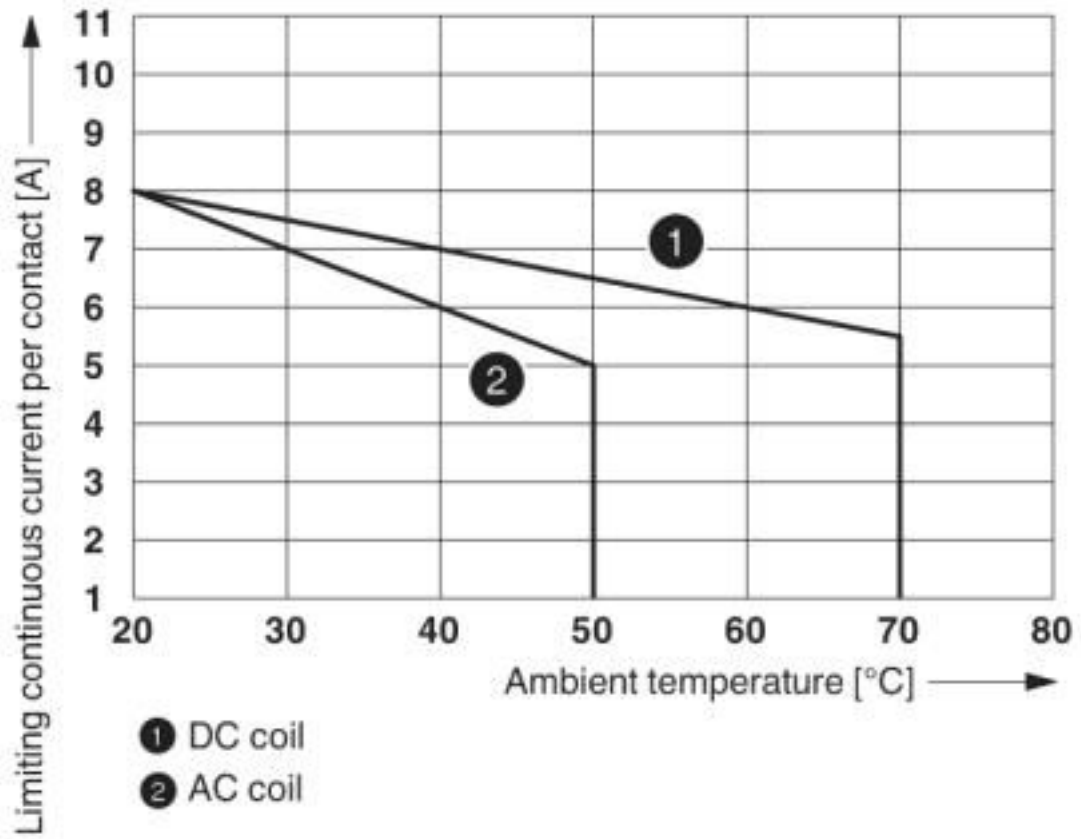

Contact derating

# Relay Module - RIF-1-RPT-LV-120AC/2X21AU - 2903328

Diagram

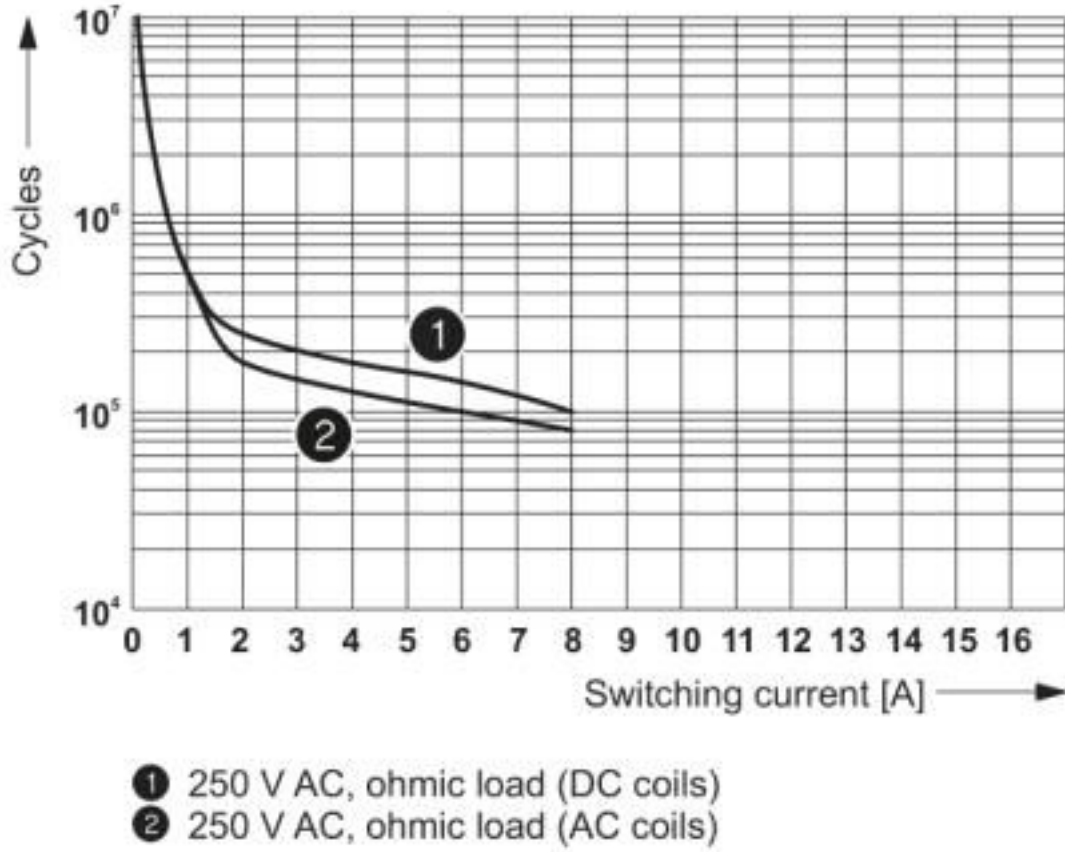

Electrical service life



## Relay Module - RIF-1-RPT-LV-120AC/2X21AU - 2903328

Diagram

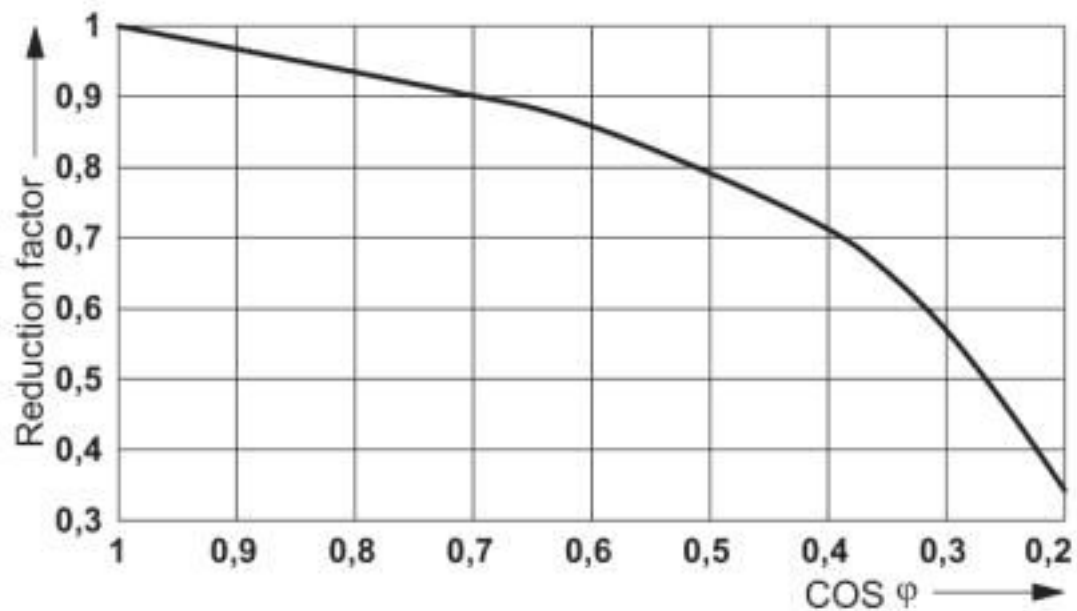

Service life reduction factor

### Articles in set

Relay base - RIF-1-BPT/2X21 - 2900931



RIF-1... relay base, for miniature power relay with 1 or 2 PDTs or solid-state relays of the same design, push-in connection, plug-in option for input/suppressor modules, for mounting on NS 35/7,5

Single relay - REL-MR-120AC/21-21AU - 2961477



Plug-in miniature power relay, with multi-layer gold contact, 2 PDTs, input voltage 120 V AC

Plug-in module - RIF-LV-120-230 AC/110 DC - 2900944



Plug-in module, for mounting on RIF-1, RIF-2, RIF-3, and RIF-4, with varistor and yellow LED, input voltage: 120 ... 230 V AC/110 V DC  $\pm 20\%$

# Relay Module - RIF-1-RPT-LV-120AC/2X21AU - 2903328

## Articles in set

Retaining bracket - RIF-RH-1 - 2900953



Relay retaining bracket, with ejector function and holder for marking material, suitable for RIF-1 relay base, for 16 mm tall miniature power relay and solid-state relay

## Classifications

### eCl@ss

eCl@ss 10.0.1	27371601
eCl@ss 4.0	27371100
eCl@ss 4.1	27371100
eCl@ss 5.0	27371600
eCl@ss 5.1	27371600
eCl@ss 6.0	27371600
eCl@ss 7.0	27371601
eCl@ss 8.0	27371601
eCl@ss 9.0	27371601

### ETIM

ETIM 2.0	EC001437
ETIM 3.0	EC001437
ETIM 4.0	EC001437
ETIM 5.0	EC001437
ETIM 6.0	EC001437
ETIM 7.0	EC001437

### UNSPSC

UNSPSC 6.01	30211916
UNSPSC 7.0901	39121515
UNSPSC 11	39121515
UNSPSC 12.01	39121515
UNSPSC 13.2	39122334
UNSPSC 18.0	39122334
UNSPSC 19.0	39122334
UNSPSC 20.0	39122334
UNSPSC 21.0	39122334

## Approvals

Approvals

# Relay Module - RIF-1-RPT-LV-120AC/2X21AU - 2903328







## Approvals

Approvals

DNV GL / PRS / LR / EAC / EAC / DNV GL

Ex Approvals

### Approval details

DNV GL		<a href="https://approvalfinder.dnvgl.com/">https://approvalfinder.dnvgl.com/</a>	TAA000018V
PRS		<a href="http://www.prs.pl/">http://www.prs.pl/</a>	TE/2108/880590/16
LR		<a href="http://www.lr.org/en">http://www.lr.org/en</a>	15/20011
EAC			TR_TS_D_00573_c
EAC			RU*C- DE.*08.B.00010
DNV GL		<a href="https://approvalfinder.dnvgl.com/">https://approvalfinder.dnvgl.com/</a>	TAA000018V

## Accessories

Accessories

DIN rail

DIN rail perforated - NS 35/ 7,5 PERF 2000MM - 0801733



DIN rail perforated, Standard profile, width: 35 mm, height: 7.5 mm, acc. to EN 60715, material: Steel, galvanized, passivated with a thick layer, length: 2000 mm, color: silver

# Relay Module - RIF-1-RPT-LV-120AC/2X21AU - 2903328

## Accessories

---

DIN rail, unperforated - NS 35/ 7,5 UNPERF 2000MM - 0801681



DIN rail, unperforated, Standard profile, width: 35 mm, height: 7.5 mm, acc. to EN 60715, material: Steel, galvanized, passivated with a thick layer, length: 2000 mm, color: silver

---

DIN rail perforated - NS 35/ 7,5 WH PERF 2000MM - 1204119



DIN rail perforated, Standard profile, width: 35 mm, height: 7.5 mm, acc. to EN 60715, material: Steel, Galvanized, white passivated, length: 2000 mm, color: silver

---

DIN rail, unperforated - NS 35/ 7,5 WH UNPERF 2000MM - 1204122



DIN rail, unperforated, Standard profile, width: 35 mm, height: 7.5 mm, acc. to EN 60715, material: Steel, Galvanized, white passivated, length: 2000 mm, color: silver

---

DIN rail, unperforated - NS 35/ 7,5 AL UNPERF 2000MM - 0801704



DIN rail, unperforated, Standard profile, width: 35 mm, height: 7.5 mm, acc. to EN 60715, material: Aluminum, uncoated, length: 2000 mm, color: silver

---

DIN rail perforated - NS 35/ 7,5 ZN PERF 2000MM - 1206421



DIN rail perforated, Standard profile, width: 35 mm, height: 7.5 mm, acc. to EN 60715, material: Steel, galvanized, length: 2000 mm, color: silver

---

## Relay Module - RIF-1-RPT-LV-120AC/2X21AU - 2903328

### Accessories

DIN rail, unperforated - NS 35/ 7,5 ZN UNPERF 2000MM - 1206434



DIN rail, unperforated, Standard profile, width: 35 mm, height: 7.5 mm, acc. to EN 60715, material: Steel, galvanized, length: 2000 mm, color: silver

---

DIN rail, unperforated - NS 35/ 7,5 CU UNPERF 2000MM - 0801762



DIN rail, unperforated, Standard profile, width: 35 mm, height: 7.5 mm, acc. to EN 60715, material: Copper, uncoated, length: 2000 mm, color: copper-colored

---

End cap - NS 35/ 7,5 CAP - 1206560



DIN rail end piece, for DIN rail NS 35/7.5

---

DIN rail perforated - NS 35/15 PERF 2000MM - 1201730



DIN rail perforated, Standard profile, width: 35 mm, height: 15 mm, similar to EN 60715, material: Steel, galvanized, passivated with a thick layer, length: 2000 mm, color: silver

---

DIN rail, unperforated - NS 35/15 UNPERF 2000MM - 1201714

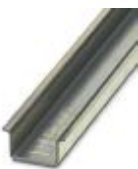

DIN rail, unperforated, Standard profile, width: 35 mm, height: 15 mm, similar to EN 60715, material: Steel, galvanized, passivated with a thick layer, length: 2000 mm, color: silver

---

## Relay Module - RIF-1-RPT-LV-120AC/2X21AU - 2903328

### Accessories

DIN rail perforated - NS 35/15 WH PERF 2000MM - 0806602



DIN rail perforated, Standard profile, width: 35 mm, height: 15 mm, similar to EN 60715, material: Steel, Galvanized, white passivated, length: 2000 mm, color: silver

---

DIN rail, unperforated - NS 35/15 WH UNPERF 2000MM - 1204135



DIN rail, unperforated, Standard profile, width: 35 mm, height: 15 mm, similar to EN 60715, material: Steel, Galvanized, white passivated, length: 2000 mm, color: silver

---

DIN rail, unperforated - NS 35/15 AL UNPERF 2000MM - 1201756



DIN rail, unperforated, Standard profile, width: 35 mm, height: 15 mm, similar to EN 60715, material: Aluminum, uncoated, length: 2000 mm, color: silver

---

DIN rail perforated - NS 35/15 ZN PERF 2000MM - 1206599



DIN rail perforated, Standard profile, width: 35 mm, height: 15 mm, similar to EN 60715, material: Steel, galvanized, length: 2000 mm, color: silver

---

DIN rail, unperforated - NS 35/15 ZN UNPERF 2000MM - 1206586



DIN rail, unperforated, Standard profile, width: 35 mm, height: 15 mm, similar to EN 60715, material: Steel, galvanized, length: 2000 mm, color: silver

---

## Relay Module - RIF-1-RPT-LV-120AC/2X21AU - 2903328

### Accessories

DIN rail, unperforated - NS 35/15 CU UNPERF 2000MM - 1201895



DIN rail, unperforated, Standard profile, width: 35 mm, height: 15 mm, similar to EN 60715, material: Copper, uncoated, length: 2000 mm, color: copper-colored

---

End cap - NS 35/15 CAP - 1206573



DIN rail end piece, for DIN rail NS 35/15

---

DIN rail, unperforated - NS 35/15-2,3 UNPERF 2000MM - 1201798



DIN rail, unperforated, Standard profile 2.3 mm, width: 35 mm, height: 15 mm, acc. to EN 60715, material: Steel, galvanized, passivated with a thick layer, length: 2000 mm, color: silver

---

End block

End clamp - CLIPFIX 35 - 3022218



Quick mounting end clamp for NS 35/7,5 DIN rail or NS 35/15 DIN rail, with marking option, width: 9.5 mm, color: gray

---

End clamp - CLIPFIX 35-5 - 3022276



Quick mounting end clamp for NS 35/7,5 DIN rail or NS 35/15 DIN rail, with marking option, with parking option for FBS...5, FBS...6, KSS 5, KSS 6, width: 5.15 mm, color: gray

---

## Relay Module - RIF-1-RPT-LV-120AC/2X21AU - 2903328

### Accessories

End clamp - E/NS 35 N - 0800886



End clamp, width: 9.5 mm, color: gray

---

### Insulating sleeve

Insulating sleeve - MPS-IH WH - 0201663

Insulating sleeve, color: white



Insulating sleeve - MPS-IH RD - 0201676

Insulating sleeve, color: red



Insulating sleeve - MPS-IH BU - 0201689

Insulating sleeve, color: blue



Insulating sleeve - MPS-IH YE - 0201692

Insulating sleeve, color: yellow





## Relay Module - RIF-1-RPT-LV-120AC/2X21AU - 2903328

### Accessories

Insulating sleeve - MPS-IH GN - 0201702

Insulating sleeve, color: green



Insulating sleeve - MPS-IH GY - 0201728

Insulating sleeve, color: gray



Insulating sleeve - MPS-IH BK - 0201731

Insulating sleeve, color: black



### Jumper

Plug-in bridge - FBS 2-6 - 3030336



Plug-in bridge, pitch: 6.2 mm, width: 10.7 mm, number of positions: 2, color: red

---

Plug-in bridge - FBS 2-6 BU - 3036932



Plug-in bridge, pitch: 6.2 mm, width: 10.7 mm, number of positions: 2, color: blue

---

## Relay Module - RIF-1-RPT-LV-120AC/2X21AU - 2903328

### Accessories

Plug-in bridge - FBS 2-6 GY - 3032237



Plug-in bridge, pitch: 6.2 mm, width: 10.7 mm, number of positions: 2, color: gray

---

Plug-in bridge - FBS 2-8 - 3030284



Plug-in bridge, pitch: 8.2 mm, width: 14.7 mm, number of positions: 2, color: red

---

Plug-in bridge - FBS 2-8 BU - 3032567



Plug-in bridge, pitch: 8.2 mm, width: 14.7 mm, number of positions: 2, color: blue

---

Plug-in bridge - FBS 2-8 GY 7042 - 3032541



Bridge for potential distribution

---

### Labeled terminal marker

Zack marker strip - ZB 5 CUS - 0824962



Zack marker strip, can be ordered: Strip, white, labeled according to customer specifications, mounting type: snap into tall marker groove, for terminal block width: 5.2 mm, lettering field size: 5.15 x 10.5 mm, Number of individual labels: 10

---

## Relay Module - RIF-1-RPT-LV-120AC/2X21AU - 2903328

### Accessories

Zack marker strip - ZB 5,LGS:FORTL.ZAHLEN - 1050017



Zack marker strip, Strip, white, labeled, printed horizontally: consecutive numbers 1 ... 10, 11 ... 20, etc. up to 491 ... 500, mounting type: snap into tall marker groove, for terminal block width: 5.2 mm, lettering field size: 5.15 x 10.5 mm, Number of individual labels: 10

Zack marker strip - ZB 5,QR:FORTL.ZAHLEN - 1050020



Zack marker strip, white, Printed vertically: consecutive numbers 1 ... 10, 11 ... 20, etc. up to 491 ... 500, mounting type: snap into tall marker groove, for terminal block width: 5.2 mm, lettering field size: 5.15 x 10.5 mm

Zack marker strip - ZB 5,LGS:GLEICHE ZAHLEN - 1050033



Zack marker strip, Strip, white, labeled, can be labeled with: CMS-P1-PLOTTER, printed horizontally: Identical numbers 1 or 2, etc. up to 100, mounting type: snap into tall marker groove, for terminal block width: 5.2 mm, lettering field size: 5.15 x 10.5 mm, Number of individual labels: 10

Zack marker strip - ZB 5,LGS:L1-N,PE - 1050415



Zack marker strip, Strip, white, labeled, horizontal: L1, L2, L3, N, PE, L1, L2, L3, N, PE, mounting type: snap into tall marker groove, for terminal block width: 5.2 mm, lettering field size: 5.15 x 10.5 mm, Number of individual labels: 10

Marker for terminal blocks - UC-TM 5 CUS - 0824581



Marker for terminal blocks, can be ordered: by sheet, white, labeled according to customer specifications, mounting type: snap into tall marker groove, for terminal block width: 5.2 mm, lettering field size: 10.5 x 4.6 mm, Number of individual labels: 96

## Relay Module - RIF-1-RPT-LV-120AC/2X21AU - 2903328

### Accessories

#### Marker for terminal blocks - UCT-TM 5 CUS - 0829595



Marker for terminal blocks, can be ordered: by sheet, white, labeled according to customer specifications, mounting type: snap into tall marker groove, for terminal block width: 5.2 mm, lettering field size: 4.6 x 10.5 mm, Number of individual labels: 72

---

#### Zack marker strip - ZB 15 CUS - 0824945



Zack marker strip, can be ordered: Strip, white, labeled according to customer specifications, mounting type: snap into tall marker groove, for terminal block width: 15.2 mm, lettering field size: 10.5 x 15.1 mm, Number of individual labels: 5

---

#### Zack marker strip - ZB 15,LGS:L1-N,PE - 0811998



Zack marker strip, Strip, white, labeled, printed horizontally: L1, L2, L3, N, PE, mounting type: snap into tall marker groove, for terminal block width: 15.2 mm, lettering field size: 10.5 x 15.1 mm, Number of individual labels: 5

---

### Marker carriers

#### Marker carriers - STP 5-2 - 0800967



Double marker carrier, snaps onto the double-level spring-cage terminal block STTB 2,5, STTB 4, PTTB 2,5, PTTB 4 can be marked with UC-TM 5, ZB 5 or UC-TMF 5, ZBF 5

---

### Terminal marking

#### Marker for terminal blocks - UC-TM 16 - 0819217



Marker for terminal blocks, Sheet, white, unlabeled, can be labeled with: BLUEMARK ID COLOR, BLUEMARK ID, BLUEMARK CLED, PLOTMARK, CMS-P1-PLOTTER, mounting type: snap into tall marker groove, for terminal block width: 16 mm, lettering field size: 15.45 x 10.5 mm, Number of individual labels: 32

## Relay Module - RIF-1-RPT-LV-120AC/2X21AU - 2903328

### Accessories

#### Marker for terminal blocks - UC-TMF 16 - 0819262



Marker for terminal blocks, Sheet, white, unlabeled, can be labeled with: BLUEMARK ID COLOR, BLUEMARK ID, BLUEMARK CLED, PLOTMARK, CMS-P1-PLOTTER, mounting type: snap into flat marker groove, for terminal block width: 16 mm, lettering field size: 15.45 x 5.1 mm, Number of individual labels: 32

#### Zack marker strip - ZB 5 :UNBEDRUCKT - 1050004



Zack marker strip, Strip, white, unlabeled, can be labeled with: PLOTMARK, CMS-P1-PLOTTER, mounting type: snap into tall marker groove, for terminal block width: 5.2 mm, lettering field size: 5.1 x 10.5 mm, Number of individual labels: 10

#### Marker for terminal blocks - UC-TM 5 - 0818108



Marker for terminal blocks, Sheet, white, unlabeled, can be labeled with: BLUEMARK ID COLOR, BLUEMARK ID, BLUEMARK CLED, PLOTMARK, CMS-P1-PLOTTER, mounting type: snap into tall marker groove, for terminal block width: 5.2 mm, lettering field size: 10.5 x 4.6 mm, Number of individual labels: 96

#### Marker for terminal blocks - UCT-TM 5 - 0828734



Marker for terminal blocks, Sheet, white, unlabeled, can be labeled with: TOPMARK NEO, TOPMARK LASER, BLUEMARK ID COLOR, BLUEMARK ID, BLUEMARK CLED, THERMOMARK PRIME, THERMOMARK CARD 2.0, THERMOMARK CARD, mounting type: snap into tall marker groove, for terminal block width: 5.2 mm, lettering field size: 4.6 x 10.5 mm, Number of individual labels: 72

#### Zack marker strip - ZB 15:UNBEDRUCKT - 0811972



Zack marker strip, Strip, white, unlabeled, can be labeled with: PLOTMARK, CMS-P1-PLOTTER, mounting type: snap into tall marker groove, for terminal block width: 15.2 mm, lettering field size: 10.5 x 15.1 mm, Number of individual labels: 5

#### Test plug terminal block

## Relay Module - RIF-1-RPT-LV-120AC/2X21AU - 2903328

### Accessories

Test plugs - MPS-MT - 0201744



Test plugs, with solder connection up to 1 mm<sup>2</sup> conductor cross section, color: gray

---

### Spare parts

Relay base - RIF-1-BPT/2X21 - 2900931



RIF-1... relay base, for miniature power relay with 1 or 2 PDTs or solid-state relays of the same design, push-in connection, plug-in option for input/suppressor modules, for mounting on NS 35/7,5

---

Single relay - REL-MR-120AC/21-21AU - 2961477



Plug-in miniature power relay, with multi-layer gold contact, 2 PDTs, input voltage 120 V AC

---

Plug-in module - RIF-LV-120-230 AC/110 DC - 2900944



Plug-in module, for mounting on RIF-1, RIF-2, RIF-3, and RIF-4, with varistor and yellow LED, input voltage: 120 ... 230 V AC/110 V DC  $\pm 20\%$

---

Retaining bracket - RIF-RH-1 - 2900953



Relay retaining bracket, with ejector function and holder for marking material, suitable for RIF-1 relay base, for 16 mm tall miniature power relay and solid-state relay

Phoenix Contact 2020 © - all rights reserved  
<http://www.phoenixcontact.com>

PHOENIX CONTACT GmbH & Co. KG  
Flachmarktstr. 8  
32825 Blomberg  
Germany  
Tel. +49 5235 300  
Fax +49 5235 3 41200  
<http://www.phoenixcontact.com>

## X-ON Electronics

Largest Supplier of Electrical and Electronic Components

*Click to view similar products for [Industrial Relays](#) category:*

*Click to view products by [Phoenix Contact](#) manufacturer:*

Other Similar products are found below :

[6-1617801-8](#) [6-1618107-9](#) [7-1618273-3](#) [EV250-4A-02](#) [EV250-6A-01](#) [FCA-125-CX8](#) [FCA-325-159](#) [FCA-410-138](#) [8000-S3121](#) [8-1618273-6](#)  
[8-1618393-1](#) [GCA63A220VAC60HZ](#) [GCA63A277VAC60HZ](#) [GCA63A600VAC60HZ](#) [1-1672275-3](#) [1-1833005-4](#) [H-16/S1](#) [A711Z](#) [H-8C](#)  
[H-8/S11](#) [H-8/S68](#) [ACC530U20](#) [ACC730U30](#) [RF303ZM4-12](#) [DH18DA](#) [1423675-8](#) [AR4-15F13-C01](#) [AR7-41F11](#) [AVR907](#) [15732A200](#)  
[B07B032AC1-0329](#) [B329](#) [B490A](#) [1618279-1](#) [BHR124Y](#) [1810DDB-SX](#) [N417](#) [P30C42A12D1-120](#) [2-1617748-6](#) [2-1618375-1](#) [2-1618396-6](#)  
[2-1618398-1](#) [JMAPD-5XL](#) [JMGACD-5M](#) [JMGSC-5LW](#) [JMGSCD-5L](#) [PBO-18A1218](#) [PBO-40A3040](#) [K8DSPH1200480VAC](#) [KA-3C-12A](#)