

Relay Module - RIF-1-RSC-LV-230AC/2X21 - 2903347

Please be informed that the data shown in this PDF Document is generated from our Online Catalog. Please find the complete data in the user's documentation. Our General Terms of Use for Downloads are valid (<http://phoenixcontact.com/download>)



Pre-assembled relay module with screw connection, consisting of: relay base, power contact relay, plug-in display/interference suppression module, and retaining bracket. Contact type: 2 changeover contacts. Input voltage: 230 V AC

Product Description

The pluggable electromechanical and solid-state relays in the RIFLINE complete product range and the base are recognized and approved in accordance with UL 508.

The relevant approvals can be called up at the individual components in question.



Key Commercial Data

Packing unit	10 pc
GTIN	 4 046356 732819
GTIN	4046356732819

Technical data

Note

Utilization restriction	EMC: class A product, see manufacturer's declaration in the download area
Type of note	Notes on operation
Note	FBS 2-6... plug-in bridge for the input side (A2) and FBS-2-8... plug-in bridge for the output side (11/21)

Dimensions

Width	16 mm
Height	89 mm
Depth	75 mm

Ambient conditions

Ambient temperature (operation)	-40 °C ... 50 °C
Ambient temperature (storage/transport)	-40 °C ... 85 °C
Degree of protection	IP20 (Relay base)
	RT III (Relay)

Relay Module - RIF-1-RSC-LV-230AC/2X21 - 2903347

Technical data

Coil side

Nominal input voltage U_N	230 V AC
Input voltage range in reference to U_N	see diagram
Mains frequency	50/60 Hz
Typical input current at U_N	6 mA
Typical response time	3 ms ... 12 ms
Typical release time range	3 ms ... 20 ms
Coil voltage	230 V AC
Protective circuit	Varistor
Operating voltage display	Yellow LED

Contact side

Contact type	2 PDT
Type of switch contact	Single contact
Contact material	AgNi
Maximum switching voltage	250 V AC/DC
Minimum switching voltage	5 V (at 10 mA)
Min. switching current	10 mA (At 5 V)
Maximum inrush current	12 A (20 ms, N/O contacts)
Limiting continuous current	8 A (see diagram)
Interrupting rating (ohmic load) max.	192 W (at 24 V DC)
	124 W (at 48 V DC)
	108 W (at 60 V DC)
	52 W (at 110 V DC)
	48 W (at 220 V DC)
	2500 VA (for 250 V AC)
Switching capacity	2 A (at 24 V, DC13)
	0.2 A (at 250 V, DC13)
	3 A (at 24 V, AC15)
	3 A (at 120 V, AC15)
	3 A (at 250 V, AC15)

General

Test voltage relay winding/relay contact	4 kV _{rms} (50 Hz, 1 min.)
Test voltage PDT/PDT	2.5 kV _{rms} (50 Hz, 1 min.)
Operating mode	100% operating factor
Flammability rating according to UL 94	V2 (Housing)
Mechanical service life	approx. 10 ⁷ cycles
Service life, electrical	see diagram
Mounting position	any
Assembly instructions	In rows with zero spacing

Connection data

Relay Module - RIF-1-RSC-LV-230AC/2X21 - 2903347

Technical data

Connection data

Connection name	Coil side
Connection method	Screw connection
Stripping length	8 mm
Conductor cross section solid	0.5 mm ² ... 4 mm ²
Conductor cross-section solid (2 conductors with same cross section)	0.5 mm ² ... 2.5 mm ²
Conductor cross section flexible	0.5 mm ² ... 4 mm ²
	0.5 mm ² ... 4 mm ² (Ferrule with plastic sleeve)
Conductor cross section flexible (2 conductors with same cross section)	0.5 mm ² ... 2.5 mm ²
	0.5 mm ² ... 1.5 mm ² (TWIN ferrule with plastic sleeve)
Conductor cross section AWG	20 ... 10 (solid)
	20 ... 12 (flexible)
Torque	0.5 Nm ... 0.6 Nm

Connection data 2

Connection name	Contact side
Connection method	Screw connection
Stripping length	8 mm
Conductor cross section solid	0.5 mm ² ... 4 mm ²
Conductor cross-section solid (2 conductors with same cross section)	0.5 mm ² ... 2.5 mm ²
Conductor cross section flexible	0.5 mm ² ... 4 mm ²
	0.5 mm ² ... 4 mm ² (Ferrule with plastic sleeve)
Conductor cross section flexible (2 conductors with same cross section)	0.5 mm ² ... 2.5 mm ²
	0.5 mm ² ... 1.5 mm ² (TWIN ferrule with plastic sleeve)
Conductor cross section AWG	20 ... 10 (solid)
	20 ... 12 (flexible)
Torque	0.5 Nm ... 0.6 Nm

Standards and Regulations

Standards/regulations	DIN EN 50178
Rated surge voltage	6 kV
Insulation	Safe isolation, basic insulation, and 4 kV rated surge voltage between all changeover contacts.
Pollution degree	2
Overvoltage category	III

Environmental Product Compliance

China RoHS	Environmentally Friendly Use Period = 50 years
	For details about hazardous substances go to tab "Downloads", Category "Manufacturer's declaration"

Drawings

Relay Module - RIF-1-RSC-LV-230AC/2X21 - 2903347

Circuit diagram

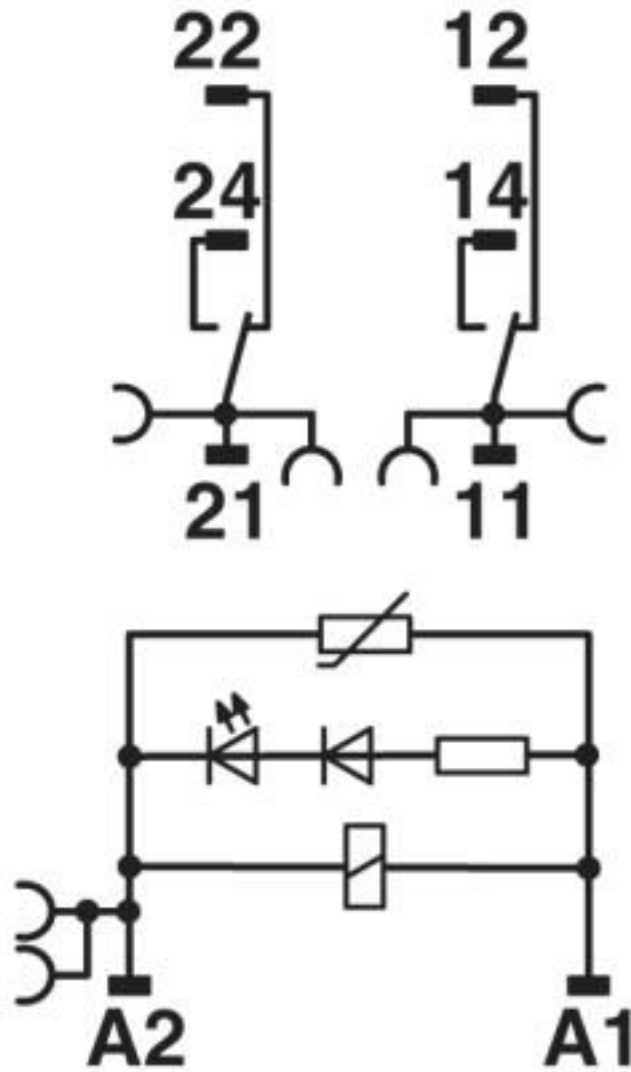

AC coils

Relay Module - RIF-1-RSC-LV-230AC/2X21 - 2903347

Diagram

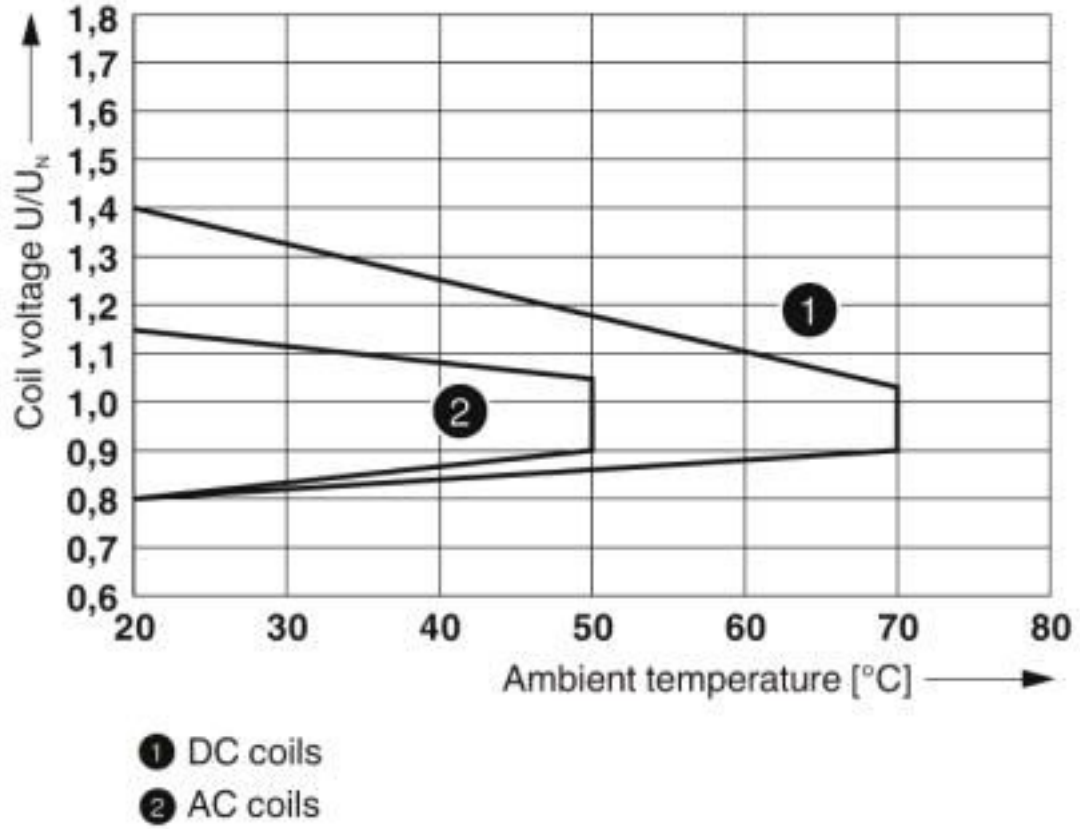

Operating voltage range

Relay Module - RIF-1-RSC-LV-230AC/2X21 - 2903347

Diagram

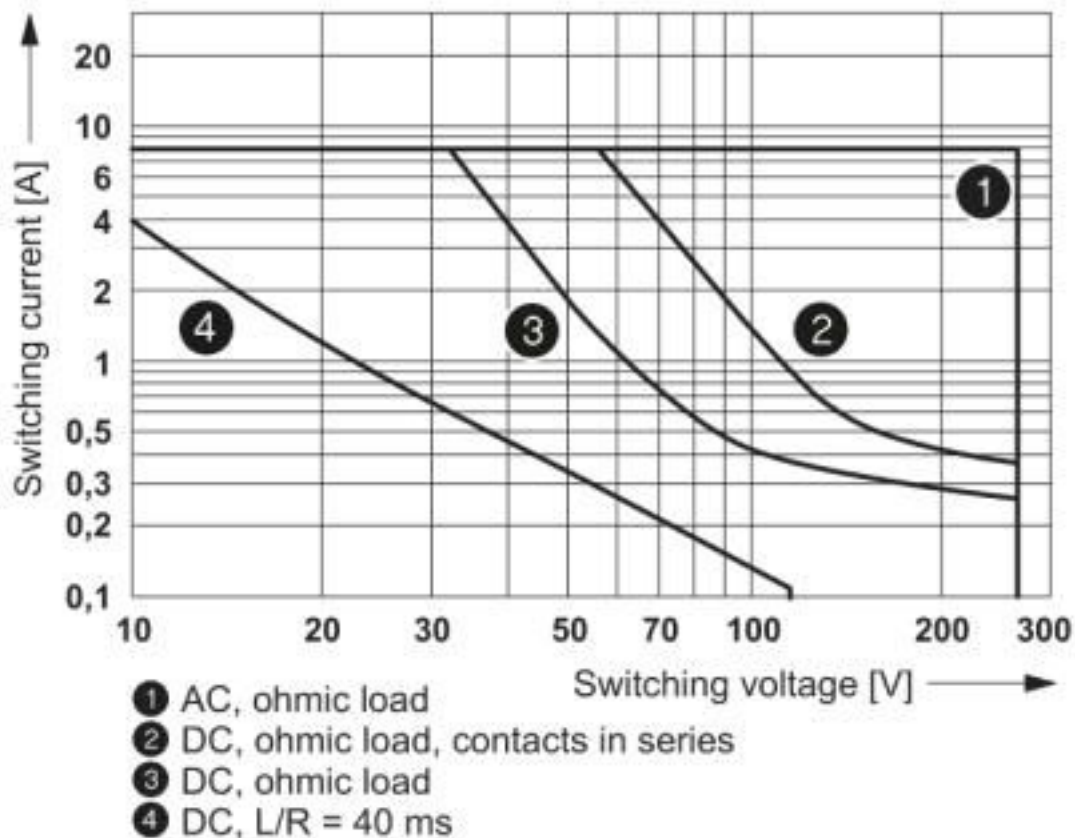

Interrupting rating

Relay Module - RIF-1-RSC-LV-230AC/2X21 - 2903347

Diagram

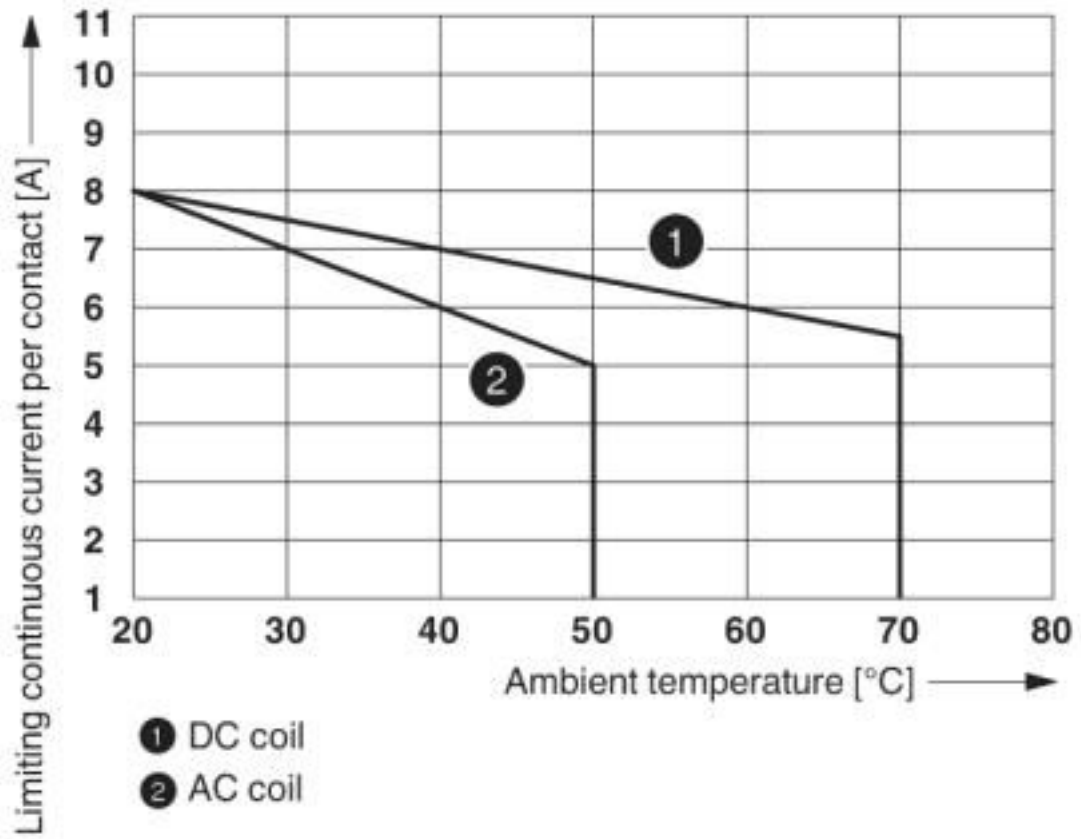

Contact derating

Relay Module - RIF-1-RSC-LV-230AC/2X21 - 2903347

Diagram

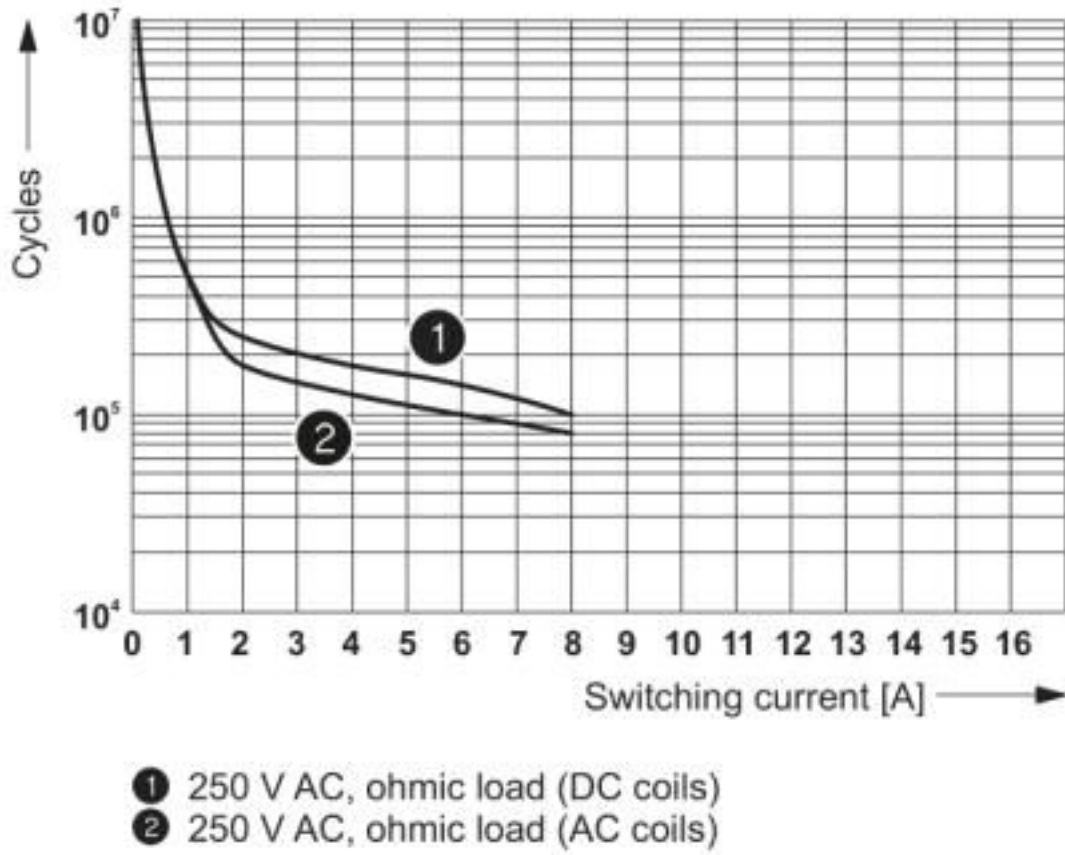

Electrical service life

Relay Module - RIF-1-RSC-LV-230AC/2X21 - 2903347

Diagram

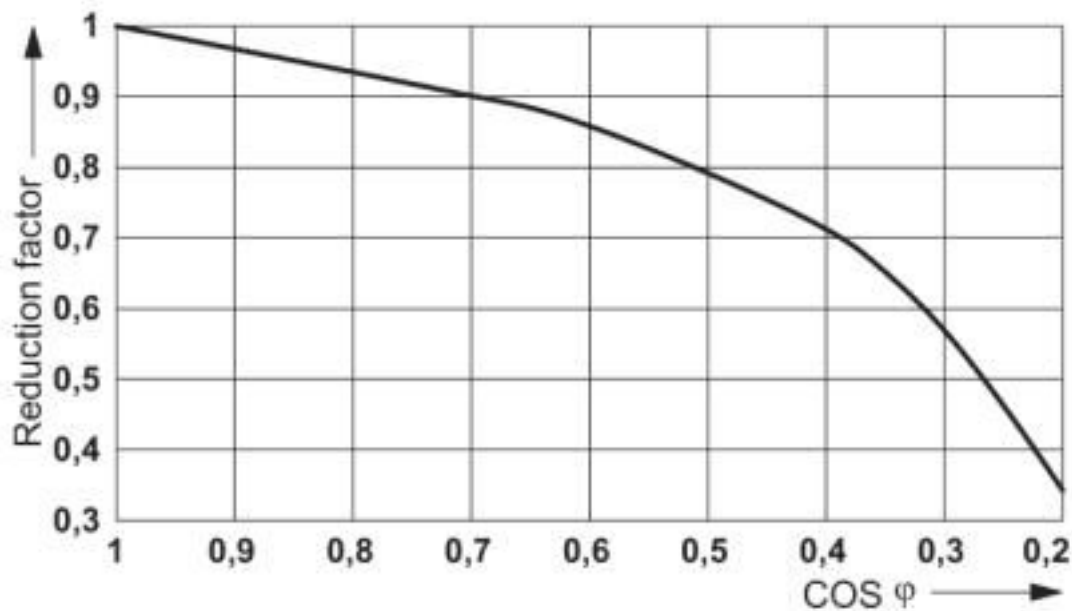

Service life reduction factor

Articles in set

Relay base - RIF-1-BSC/2X21 - 2900930



RIF-1... relay base, for miniature power relay with 1 or 2 changeover contacts or identical solid-state relays, screw connection, plug-in option for input/interference suppression modules, for mounting on NS 35/7,5

Single relay - REL-MR-230AC/21-21 - 2961451



Plug-in miniature power relay, with power contact, 2 PDTs, input voltage 230 V AC

Plug-in module - RIF-LV-120-230 AC/110 DC - 2900944



Plug-in module, for mounting on RIF-1, RIF-2, RIF-3, and RIF-4, with varistor and yellow LED, input voltage: 120 ... 230 V AC/110 V DC $\pm 20\%$

Relay Module - RIF-1-RSC-LV-230AC/2X21 - 2903347

Articles in set

Retaining bracket - RIF-RH-1 - 2900953



Relay retaining bracket, with ejector function and holder for marking material, suitable for RIF-1 relay base, for 16 mm tall miniature power relay and solid-state relay

Classifications

eCl@ss

eCl@ss 10.0.1	27371601
eCl@ss 4.0	27371100
eCl@ss 4.1	27371100
eCl@ss 5.0	27371600
eCl@ss 5.1	27371600
eCl@ss 6.0	27371600
eCl@ss 7.0	27371601
eCl@ss 8.0	27371601
eCl@ss 9.0	27371601

ETIM

ETIM 2.0	EC001437
ETIM 3.0	EC001437
ETIM 4.0	EC001437
ETIM 5.0	EC001437
ETIM 6.0	EC001437
ETIM 7.0	EC001437

UNSPSC

UNSPSC 6.01	30211917
UNSPSC 7.0901	39121516
UNSPSC 11	39121516
UNSPSC 12.01	39121516
UNSPSC 13.2	39122334
UNSPSC 18.0	39122334
UNSPSC 19.0	39122334
UNSPSC 20.0	39122334
UNSPSC 21.0	39122334

Approvals

Approvals

Relay Module - RIF-1-RSC-LV-230AC/2X21 - 2903347

Approvals

Approvals

DNV GL / EAC / EAC

Ex Approvals

Approval details

DNV GL		https://approvalfinder.dnvgl.com/	TAA000018V
--------	--	---	------------

EAC			TR_TS_D_00573_c
-----	--	--	-----------------

EAC			RU*C- DE.*08.B.00010
-----	--	--	-------------------------

Accessories

Accessories

DIN rail

DIN rail perforated - NS 35/ 7,5 PERF 2000MM - 0801733



DIN rail perforated, Standard profile, width: 35 mm, height: 7.5 mm, acc. to EN 60715, material: Steel, galvanized, passivated with a thick layer, length: 2000 mm, color: silver

DIN rail, unperforated - NS 35/ 7,5 UNPERF 2000MM - 0801681



DIN rail, unperforated, Standard profile, width: 35 mm, height: 7.5 mm, acc. to EN 60715, material: Steel, galvanized, passivated with a thick layer, length: 2000 mm, color: silver

Relay Module - RIF-1-RSC-LV-230AC/2X21 - 2903347

Accessories

DIN rail perforated - NS 35/ 7,5 WH PERF 2000MM - 1204119



DIN rail perforated, Standard profile, width: 35 mm, height: 7.5 mm, acc. to EN 60715, material: Steel, Galvanized, white passivated, length: 2000 mm, color: silver

DIN rail, unperforated - NS 35/ 7,5 WH UNPERF 2000MM - 1204122



DIN rail, unperforated, Standard profile, width: 35 mm, height: 7.5 mm, acc. to EN 60715, material: Steel, Galvanized, white passivated, length: 2000 mm, color: silver

DIN rail, unperforated - NS 35/ 7,5 AL UNPERF 2000MM - 0801704



DIN rail, unperforated, Standard profile, width: 35 mm, height: 7.5 mm, acc. to EN 60715, material: Aluminum, uncoated, length: 2000 mm, color: silver

DIN rail perforated - NS 35/ 7,5 ZN PERF 2000MM - 1206421



DIN rail perforated, Standard profile, width: 35 mm, height: 7.5 mm, acc. to EN 60715, material: Steel, galvanized, length: 2000 mm, color: silver

DIN rail, unperforated - NS 35/ 7,5 ZN UNPERF 2000MM - 1206434



DIN rail, unperforated, Standard profile, width: 35 mm, height: 7.5 mm, acc. to EN 60715, material: Steel, galvanized, length: 2000 mm, color: silver

Relay Module - RIF-1-RSC-LV-230AC/2X21 - 2903347

Accessories

DIN rail, unperforated - NS 35/ 7,5 CU UNPERF 2000MM - 0801762



DIN rail, unperforated, Standard profile, width: 35 mm, height: 7.5 mm, acc. to EN 60715, material: Copper, uncoated, length: 2000 mm, color: copper-colored

End cap - NS 35/ 7,5 CAP - 1206560



DIN rail end piece, for DIN rail NS 35/7.5

DIN rail perforated - NS 35/15 PERF 2000MM - 1201730



DIN rail perforated, Standard profile, width: 35 mm, height: 15 mm, similar to EN 60715, material: Steel, galvanized, passivated with a thick layer, length: 2000 mm, color: silver

DIN rail, unperforated - NS 35/15 UNPERF 2000MM - 1201714



DIN rail, unperforated, Standard profile, width: 35 mm, height: 15 mm, similar to EN 60715, material: Steel, galvanized, passivated with a thick layer, length: 2000 mm, color: silver

DIN rail perforated - NS 35/15 WH PERF 2000MM - 0806602



DIN rail perforated, Standard profile, width: 35 mm, height: 15 mm, similar to EN 60715, material: Steel, Galvanized, white passivated, length: 2000 mm, color: silver

Relay Module - RIF-1-RSC-LV-230AC/2X21 - 2903347

Accessories

DIN rail, unperforated - NS 35/15 WH UNPERF 2000MM - 1204135



DIN rail, unperforated, Standard profile, width: 35 mm, height: 15 mm, similar to EN 60715, material: Steel, Galvanized, white passivated, length: 2000 mm, color: silver

DIN rail, unperforated - NS 35/15 AL UNPERF 2000MM - 1201756



DIN rail, unperforated, Standard profile, width: 35 mm, height: 15 mm, similar to EN 60715, material: Aluminum, uncoated, length: 2000 mm, color: silver

DIN rail perforated - NS 35/15 ZN PERF 2000MM - 1206599



DIN rail perforated, Standard profile, width: 35 mm, height: 15 mm, similar to EN 60715, material: Steel, galvanized, length: 2000 mm, color: silver

DIN rail, unperforated - NS 35/15 ZN UNPERF 2000MM - 1206586



DIN rail, unperforated, Standard profile, width: 35 mm, height: 15 mm, similar to EN 60715, material: Steel, galvanized, length: 2000 mm, color: silver

DIN rail, unperforated - NS 35/15 CU UNPERF 2000MM - 1201895



DIN rail, unperforated, Standard profile, width: 35 mm, height: 15 mm, similar to EN 60715, material: Copper, uncoated, length: 2000 mm, color: copper-colored

Relay Module - RIF-1-RSC-LV-230AC/2X21 - 2903347

Accessories

End cap - NS 35/15 CAP - 1206573



DIN rail end piece, for DIN rail NS 35/15

DIN rail, unperforated - NS 35/15-2,3 UNPERF 2000MM - 1201798



DIN rail, unperforated, Standard profile 2.3 mm, width: 35 mm, height: 15 mm, acc. to EN 60715, material: Steel, galvanized, passivated with a thick layer, length: 2000 mm, color: silver

End block

End clamp - CLIPFIX 35 - 3022218



Quick mounting end clamp for NS 35/7,5 DIN rail or NS 35/15 DIN rail, with marking option, width: 9.5 mm, color: gray

End clamp - CLIPFIX 35-5 - 3022276



Quick mounting end clamp for NS 35/7,5 DIN rail or NS 35/15 DIN rail, with marking option, with parking option for FBS...5, FBS...6, KSS 5, KSS 6, width: 5.15 mm, color: gray

End clamp - E/NS 35 N - 0800886



End clamp, width: 9.5 mm, color: gray

Insulating sleeve

Relay Module - RIF-1-RSC-LV-230AC/2X21 - 2903347

Accessories

Insulating sleeve - MPS-IH WH - 0201663

Insulating sleeve, color: white



Insulating sleeve - MPS-IH RD - 0201676

Insulating sleeve, color: red



Insulating sleeve - MPS-IH BU - 0201689

Insulating sleeve, color: blue



Insulating sleeve - MPS-IH YE - 0201692

Insulating sleeve, color: yellow



Insulating sleeve - MPS-IH GN - 0201702

Insulating sleeve, color: green



Relay Module - RIF-1-RSC-LV-230AC/2X21 - 2903347

Accessories

Insulating sleeve - MPS-IH GY - 0201728

Insulating sleeve, color: gray



Insulating sleeve - MPS-IH BK - 0201731

Insulating sleeve, color: black



Jumper

Plug-in bridge - FBS 2-6 - 3030336



Plug-in bridge, pitch: 6.2 mm, width: 10.7 mm, number of positions: 2, color: red

Plug-in bridge - FBS 2-6 BU - 3036932



Plug-in bridge, pitch: 6.2 mm, width: 10.7 mm, number of positions: 2, color: blue

Plug-in bridge - FBS 2-6 GY - 3032237



Plug-in bridge, pitch: 6.2 mm, width: 10.7 mm, number of positions: 2, color: gray

Relay Module - RIF-1-RSC-LV-230AC/2X21 - 2903347

Accessories

Plug-in bridge - FBS 2-8 - 3030284



Plug-in bridge, pitch: 8.2 mm, width: 14.7 mm, number of positions: 2, color: red

Plug-in bridge - FBS 2-8 BU - 3032567



Plug-in bridge, pitch: 8.2 mm, width: 14.7 mm, number of positions: 2, color: blue

Plug-in bridge - FBS 2-8 GY 7042 - 3032541



Bridge for potential distribution

Labeled terminal marker

Zack marker strip - ZB 5 CUS - 0824962



Zack marker strip, can be ordered: Strip, white, labeled according to customer specifications, mounting type: snap into tall marker groove, for terminal block width: 5.2 mm, lettering field size: 5.15 x 10.5 mm, Number of individual labels: 10

Zack marker strip - ZB 5,LGS:FORTL.ZAHLEN - 1050017



Zack marker strip, Strip, white, labeled, printed horizontally: consecutive numbers 1 ... 10, 11 ... 20, etc. up to 491 ... 500, mounting type: snap into tall marker groove, for terminal block width: 5.2 mm, lettering field size: 5.15 x 10.5 mm, Number of individual labels: 10

Relay Module - RIF-1-RSC-LV-230AC/2X21 - 2903347

Accessories

Zack marker strip - ZB 5,QR:FORTL.ZAHLEN - 1050020



Zack marker strip, white, Printed vertically: consecutive numbers 1 ... 10, 11 ... 20, etc. up to 491 ... 500, mounting type: snap into tall marker groove, for terminal block width: 5.2 mm, lettering field size: 5.15 x 10.5 mm

Zack marker strip - ZB 5,LGS:GLEICHE ZAHLEN - 1050033



Zack marker strip, Strip, white, labeled, can be labeled with: CMS-P1-PLOTTER, printed horizontally: Identical numbers 1 or 2, etc. up to 100, mounting type: snap into tall marker groove, for terminal block width: 5.2 mm, lettering field size: 5.15 x 10.5 mm, Number of individual labels: 10

Zack marker strip - ZB 5,LGS:L1-N,PE - 1050415



Zack marker strip, Strip, white, labeled, horizontal: L1, L2, L3, N, PE, L1, L2, L3, N, PE, mounting type: snap into tall marker groove, for terminal block width: 5.2 mm, lettering field size: 5.15 x 10.5 mm, Number of individual labels: 10

Marker for terminal blocks - UC-TM 5 CUS - 0824581



Marker for terminal blocks, can be ordered: by sheet, white, labeled according to customer specifications, mounting type: snap into tall marker groove, for terminal block width: 5.2 mm, lettering field size: 10.5 x 4.6 mm, Number of individual labels: 96

Marker for terminal blocks - UCT-TM 5 CUS - 0829595



Marker for terminal blocks, can be ordered: by sheet, white, labeled according to customer specifications, mounting type: snap into tall marker groove, for terminal block width: 5.2 mm, lettering field size: 4.6 x 10.5 mm, Number of individual labels: 72

Relay Module - RIF-1-RSC-LV-230AC/2X21 - 2903347

Accessories

Zack marker strip - ZB 15 CUS - 0824945



Zack marker strip, can be ordered: Strip, white, labeled according to customer specifications, mounting type: snap into tall marker groove, for terminal block width: 15.2 mm, lettering field size: 10.5 x 15.1 mm, Number of individual labels: 5

Zack marker strip - ZB 15,LGS:L1-N,PE - 0811998



Zack marker strip, Strip, white, labeled, printed horizontally: L1, L2, L3, N, PE, mounting type: snap into tall marker groove, for terminal block width: 15.2 mm, lettering field size: 10.5 x 15.1 mm, Number of individual labels: 5

Marker carriers

Marker carriers - STP 5-2 - 0800967



Double marker carrier, snaps onto the double-level spring-cage terminal block STTB 2,5, STTB 4, PTTB 2,5, PTTB 4 can be marked with UC-TM 5, ZB 5 or UC-TMF 5, ZBF 5

Terminal marking

Marker for terminal blocks - UC-TM 16 - 0819217



Marker for terminal blocks, Sheet, white, unlabeled, can be labeled with: BLUEMARK ID COLOR, BLUEMARK ID, BLUEMARK CLED, PLOTMARK, CMS-P1-PLOTTER, mounting type: snap into tall marker groove, for terminal block width: 16 mm, lettering field size: 15.45 x 10.5 mm, Number of individual labels: 32

Marker for terminal blocks - UC-TMF 16 - 0819262



Marker for terminal blocks, Sheet, white, unlabeled, can be labeled with: BLUEMARK ID COLOR, BLUEMARK ID, BLUEMARK CLED, PLOTMARK, CMS-P1-PLOTTER, mounting type: snap into flat marker groove, for terminal block width: 16 mm, lettering field size: 15.45 x 5.1 mm, Number of individual labels: 32

Relay Module - RIF-1-RSC-LV-230AC/2X21 - 2903347

Accessories

Zack marker strip - ZB 5 :UNBEDRUCKT - 1050004



Zack marker strip, Strip, white, unlabeled, can be labeled with: PLOTMARK, CMS-P1-PLOTTER, mounting type: snap into tall marker groove, for terminal block width: 5.2 mm, lettering field size: 5.1 x 10.5 mm, Number of individual labels: 10

Marker for terminal blocks - UC-TM 5 - 0818108



Marker for terminal blocks, Sheet, white, unlabeled, can be labeled with: BLUEMARK ID COLOR, BLUEMARK ID, BLUEMARK CLED, PLOTMARK, CMS-P1-PLOTTER, mounting type: snap into tall marker groove, for terminal block width: 5.2 mm, lettering field size: 10.5 x 4.6 mm, Number of individual labels: 96

Marker for terminal blocks - UCT-TM 5 - 0828734



Marker for terminal blocks, Sheet, white, unlabeled, can be labeled with: TOPMARK NEO, TOPMARK LASER, BLUEMARK ID COLOR, BLUEMARK ID, BLUEMARK CLED, THERMOMARK PRIME, THERMOMARK CARD 2.0, THERMOMARK CARD, mounting type: snap into tall marker groove, for terminal block width: 5.2 mm, lettering field size: 4.6 x 10.5 mm, Number of individual labels: 72

Zack marker strip - ZB 15:UNBEDRUCKT - 0811972



Zack marker strip, Strip, white, unlabeled, can be labeled with: PLOTMARK, CMS-P1-PLOTTER, mounting type: snap into tall marker groove, for terminal block width: 15.2 mm, lettering field size: 10.5 x 15.1 mm, Number of individual labels: 5

Test plug terminal block

Test plugs - MPS-MT - 0201744



Test plugs, with solder connection up to 1 mm² conductor cross section, color: gray

Spare parts

Relay Module - RIF-1-RSC-LV-230AC/2X21 - 2903347

Accessories

Relay base - RIF-1-BSC/2X21 - 2900930



RIF-1... relay base, for miniature power relay with 1 or 2 changeover contacts or identical solid-state relays, screw connection, plug-in option for input/interference suppression modules, for mounting on NS 35/7,5

Single relay - REL-MR-230AC/21-21 - 2961451



Plug-in miniature power relay, with power contact, 2 PDTs, input voltage 230 V AC

Plug-in module - RIF-LV-120-230 AC/110 DC - 2900944



Plug-in module, for mounting on RIF-1, RIF-2, RIF-3, and RIF-4, with varistor and yellow LED, input voltage: 120 ... 230 V AC/110 V DC $\pm 20\%$

Retaining bracket - RIF-RH-1 - 2900953



Relay retaining bracket, with ejector function and holder for marking material, suitable for RIF-1 relay base, for 16 mm tall miniature power relay and solid-state relay

Phoenix Contact 2020 © - all rights reserved
<http://www.phoenixcontact.com>

PHOENIX CONTACT GmbH & Co. KG
Flachsmarktstr. 8
32825 Blomberg
Germany
Tel. +49 5235 300
Fax +49 5235 3 41200
<http://www.phoenixcontact.com>

X-ON Electronics

Largest Supplier of Electrical and Electronic Components

Click to view similar products for [Industrial Relays](#) category:

Click to view products by [Phoenix Contact](#) manufacturer:

Other Similar products are found below :

[6-1617801-8](#) [6-1618107-9](#) [7-1618273-3](#) [EV250-4A-02](#) [EV250-6A-01](#) [FCA-125-CX8](#) [FCA-325-159](#) [FCA-410-138](#) [8000-S3121](#) [8-1618273-6](#)
[8-1618393-1](#) [GCA63A220VAC60HZ](#) [GCA63A277VAC60HZ](#) [GCA63A600VAC60HZ](#) [1-1672275-3](#) [1-1833005-4](#) [H-16/S1](#) [A711Z](#) [H-8C](#)
[H-8/S11](#) [H-8/S68](#) [ACC530U20](#) [ACC730U30](#) [RF303ZM4-12](#) [DH18DA](#) [1423675-8](#) [AR4-15F13-C01](#) [AR7-41F11](#) [AVR907](#) [15732A200](#)
[B07B032AC1-0329](#) [B329](#) [B490A](#) [1618279-1](#) [BHR124Y](#) [1810DDB-SX](#) [N417](#) [P30C42A12D1-120](#) [2-1617748-6](#) [2-1618375-1](#) [2-1618396-6](#)
[2-1618398-1](#) [JMAPD-5XL](#) [JMGACD-5M](#) [JMGSC-5LW](#) [JMGSCD-5L](#) [PBO-18A1218](#) [PBO-40A3040](#) [K8DSPH1200480VAC](#) [KA-3C-12A](#)