

Single relay - REL-OR2/L-120AC/2X21 - 2903691

Please be informed that the data shown in this PDF Document is generated from our Online Catalog. Please find the complete data in the user's documentation. Our General Terms of Use for Downloads are valid (<http://phoenixcontact.com/download>)



Pluggable octal relay with power contacts, 2 PDT, test button, mechanical switching position indication, coil voltage 120 V AC



Key Commercial Data

Packing unit	10 pc
Minimum order quantity	10 pc
GTIN	 4 046356 759045
GTIN	4046356759045

Technical data

Dimensions

Width	35 mm
Height	35 mm
Depth	54.4 mm

Ambient conditions

Ambient temperature (operation)	-40 °C ... 55 °C
Ambient temperature (storage/transport)	-40 °C ... 85 °C
Degree of protection	RT I

Coil side

Nominal input voltage U_N	120 V AC
Input voltage range in reference to U_N	see diagram
Mains frequency	50/60 Hz
Typical input current at U_N	23 mA
Typical response time	5 ms ... 15 ms (depending on phase relation)
Typical release time range	5 ms ... 20 ms (depending on phase relation)
Status display	Yellow LED

Single relay - REL-OR2/L-120AC/2X21 - 2903691

Technical data

Coil side

Power dissipation for nominal condition	2.76 W
---	--------

Contact side

Contact type	2 PDT
Type of switch contact	Single contact
Contact material	AgNi
Maximum switching voltage	250 V AC/DC
Minimum switching voltage	10 V (At 24 mA)
Min. switching current	10 mA (at 24 V)
Maximum inrush current	30 A (20 ms, N/O contacts)
Limiting continuous current	10 A
Interrupting rating (ohmic load) max.	240 W (at 24 V DC)
	124 W (at 48 V DC)
	108 W (at 60 V DC)
	52 W (at 110 V DC)
	48 W (at 220 V DC)
	2500 VA (for 250 V AC)
Switching capacity min.	0.24 W
Switching capacity	2 A (at 24 V, DC13)
	0.22 A (at 120 V, DC13)
	0.11 A (at 250 V, DC13)
	3 A (at 24 V, AC15)
	3 A (at 120 V, AC15)
	1.5 A (at 240 V, AC15)
Motor load according to UL 508	1/2 HP, 240 V AC (N/O contact)

General

Test voltage relay winding/relay contact	2.5 kV _{rms} (50 Hz, 1 min.)
Test voltage relay contact/relay contact	2 kV _{rms} (50 Hz, 1 min.)
Test voltage PDT/PDT	2 kV _{rms} (50 Hz, 1 min.)
Operating mode	100% operating factor
Mechanical service life	approx. 2x 10 ⁷ cycles
Mounting position	any

Connection data

Connection method	Plug connection
-------------------	-----------------

Standards and Regulations

Connection in acc. with standard	CSA
Standards/regulations	IEC 60664
	IEC 61810
Rated insulation voltage	250 V AC
Rated surge voltage	4 kV

Single relay - REL-OR2/L-120AC/2X21 - 2903691

Technical data

Standards and Regulations

Insulation	Basic insulation
Pollution degree	3
Overvoltage category	III

Environmental Product Compliance

China RoHS	Environmentally Friendly Use Period = 50 years
	For details about hazardous substances go to tab "Downloads", Category "Manufacturer's declaration"

Drawings

Diagram

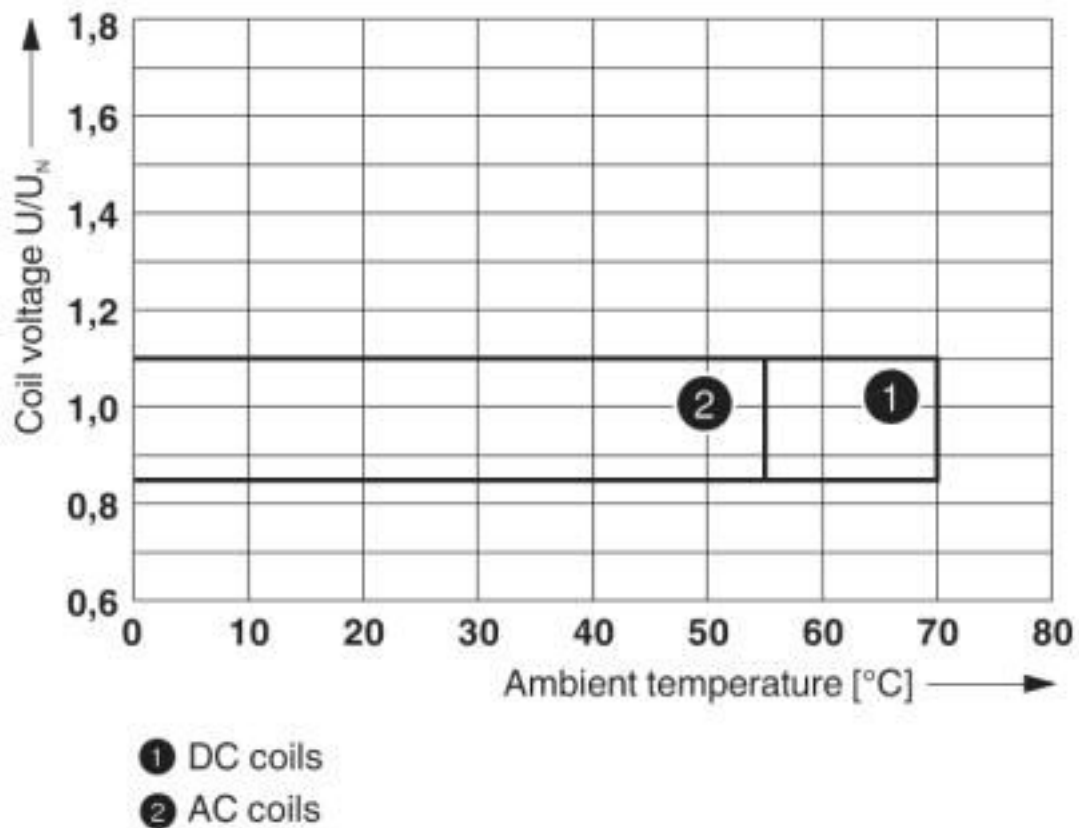

Operating voltage range

Single relay - REL-OR2/L-120AC/2X21 - 2903691

Diagram

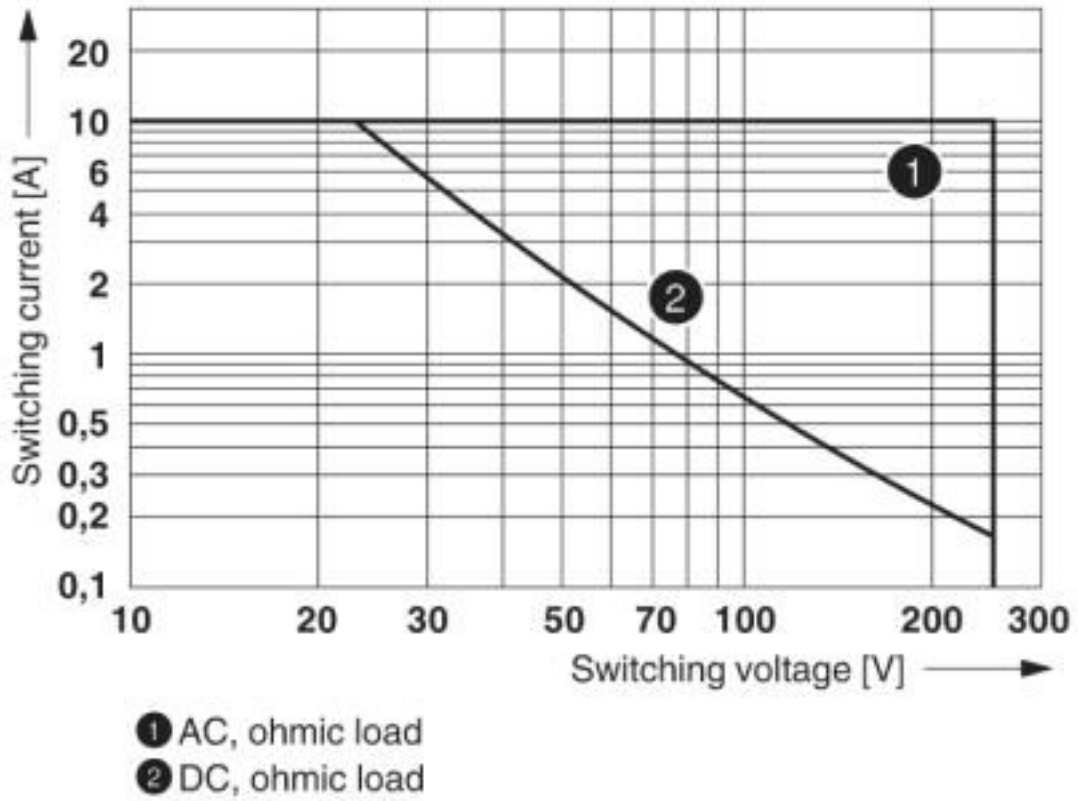

Interrupting rating

Single relay - REL-OR2/L-120AC/2X21 - 2903691

Diagram

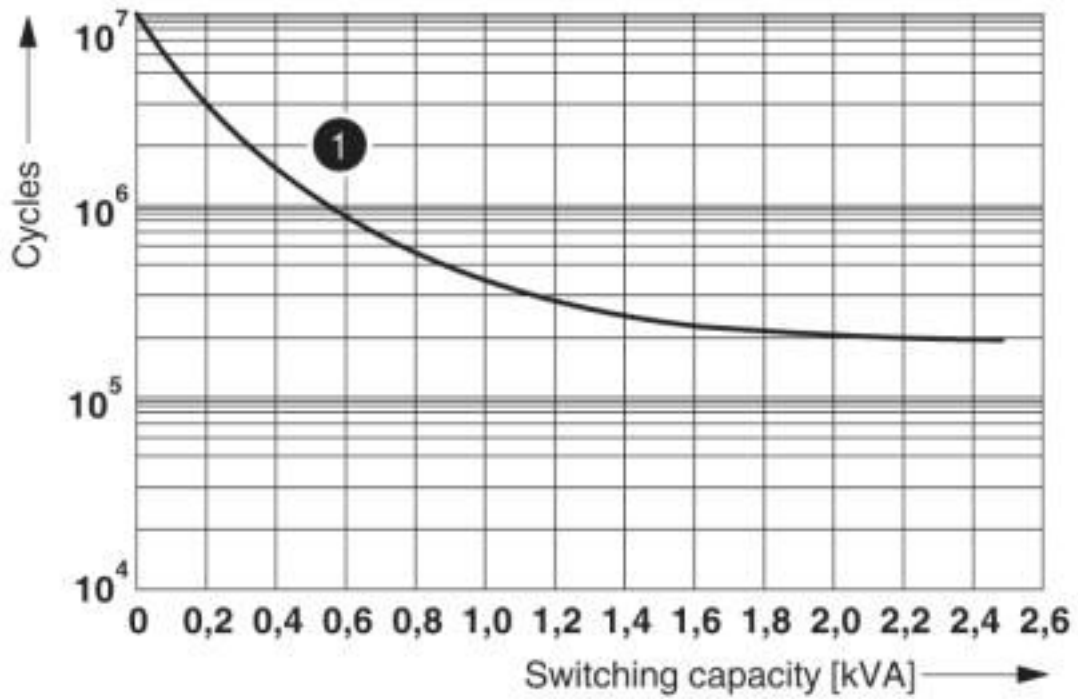

① 250 V AC, ohmic load

Electrical service life

Diagram

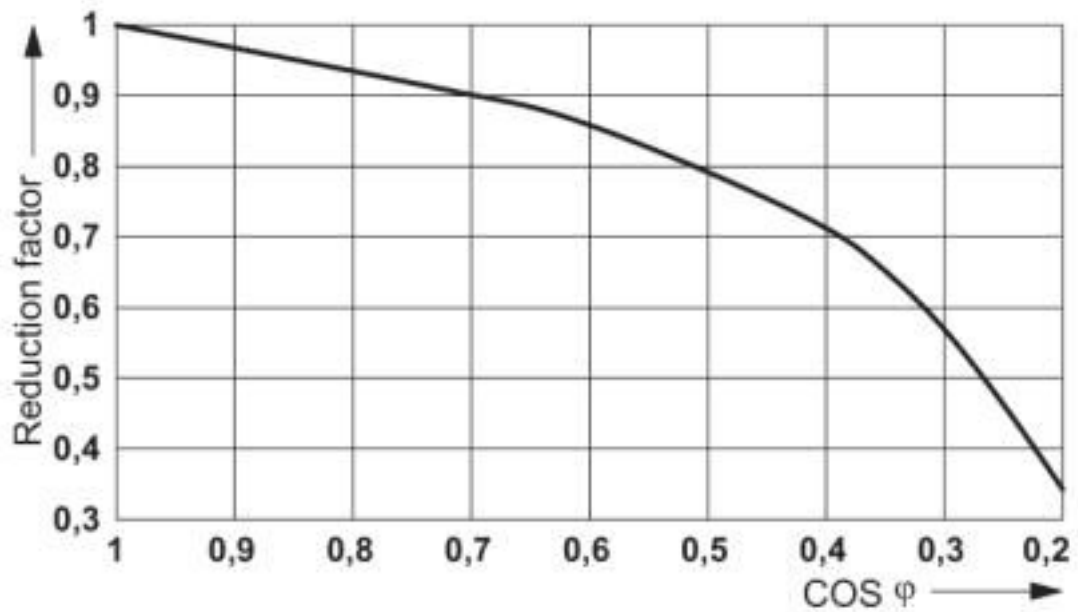

Service life reduction factor

Single relay - REL-OR2/L-120AC/2X21 - 2903691

Circuit diagram

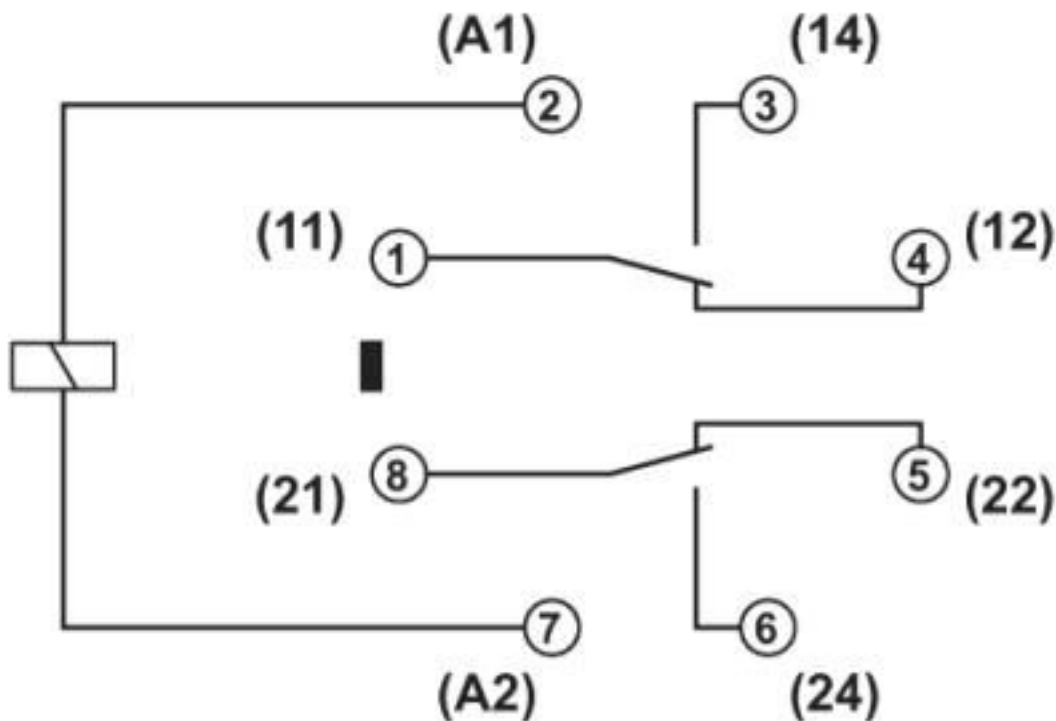

Classifications

eCl@ss

eCl@ss 10.0.1	27371601
eCl@ss 4.0	27371100
eCl@ss 4.1	27371100
eCl@ss 5.0	27371600
eCl@ss 5.1	27371600
eCl@ss 6.0	27371600
eCl@ss 7.0	27371601
eCl@ss 8.0	27371601
eCl@ss 9.0	27371601

ETIM

ETIM 2.0	EC001437
ETIM 3.0	EC001437
ETIM 4.0	EC001437
ETIM 5.0	EC001437
ETIM 6.0	EC001437
ETIM 7.0	EC001437

Single relay - REL-OR2/L-120AC/2X21 - 2903691

Classifications

UNSPSC

UNSPSC 6.01	30211916
UNSPSC 7.0901	39121515
UNSPSC 11	39121515
UNSPSC 12.01	39121515
UNSPSC 13.2	39122334
UNSPSC 18.0	39122334
UNSPSC 19.0	39122334
UNSPSC 20.0	39122334
UNSPSC 21.0	39122334

Approvals

Approvals

Approvals

CSA / UL Recognized / cUL Recognized / VDE Zeichengenehmigung / EAC / EAC / cULus Recognized

Ex Approvals

Approval details

CSA		http://www.csagroup.org/services-industries/product-listing/	2554095
-----	--	---	---------

UL Recognized		http://database.ul.com/cgi-bin/XYV/template/LISEXT/1FRAME/index.htm	FILE E 172140
---------------	--	---	---------------

cUL Recognized		http://database.ul.com/cgi-bin/XYV/template/LISEXT/1FRAME/index.htm	FILE E 172140
----------------	--	---	---------------

VDE Zeichengenehmigung		http://www2.vde.com/de/Institut/Online-Service/VDE-gepruefteProdukte/Seiten/Online-Suche.aspx	40036588
------------------------	--	---	----------

EAC			TR_TS_D_00573_c
-----	--	--	-----------------

Single relay - REL-OR2/L-120AC/2X21 - 2903691

Approvals

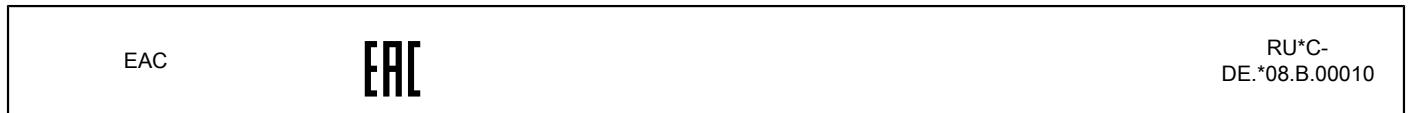

Accessories

Additional products

Relay base - RIF-3-BPT/2X21 - 2900937



RIF-3... relay base, for octal relay with 2 PDTs, push-in connection, plug-in option for input/suppressor modules, for mounting on NS 35/7,5

Relay base - RIF-3-BSC/2X21 - 2900935



RIF-3... relay base, for octal relay with 2 changeover contacts, screw connection, plug-in option for input/interference suppression modules, for mounting on NS 35/7,5

Phoenix Contact 2020 © - all rights reserved
<http://www.phoenixcontact.com>

PHOENIX CONTACT GmbH & Co. KG
Flachsmarktstr. 8
32825 Blomberg
Germany
Tel. +49 5235 300
Fax +49 5235 3 41200
<http://www.phoenixcontact.com>

X-ON Electronics

Largest Supplier of Electrical and Electronic Components

Click to view similar products for [Industrial Relays](#) category:

Click to view products by [Phoenix Contact](#) manufacturer:

Other Similar products are found below :

[6-1617801-8](#) [6-1618107-9](#) [7-1618273-3](#) [EV250-4A-02](#) [EV250-6A-01](#) [FCA-125-CX8](#) [FCA-325-159](#) [FCA-410-138](#) [8000-S3121](#) [8-1618273-6](#)
[8-1618393-1](#) [GCA63A220VAC60HZ](#) [GCA63A277VAC60HZ](#) [GCA63A600VAC60HZ](#) [1-1672275-3](#) [1-1833005-4](#) [H-16/S1](#) [A711Z](#) [H-8C](#)
[H-8/S11](#) [H-8/S68](#) [ACC530U20](#) [ACC730U30](#) [RF303ZM4-12](#) [DH18DA](#) [1423675-8](#) [AR4-15F13-C01](#) [AR7-41F11](#) [AVR907](#) [15732A200](#)
[B07B032AC1-0329](#) [B329](#) [B490A](#) [1618279-1](#) [BHR124Y](#) [1810DDB-SX](#) [N417](#) [P30C42A12D1-120](#) [2-1617748-6](#) [2-1618375-1](#) [2-1618396-6](#)
[2-1618398-1](#) [JMAPD-5XL](#) [JMGACD-5M](#) [JMGSC-5LW](#) [JMGSCD-5L](#) [PBO-18A1218](#) [PBO-40A3040](#) [K8DSPH1200480VAC](#) [KA-3C-12A](#)