

# Single relay - REL-OR3/L-230AC/3X21 - 2903696

Please be informed that the data shown in this PDF Document is generated from our Online Catalog. Please find the complete data in the user's documentation. Our General Terms of Use for Downloads are valid (<http://phoenixcontact.com/download>)



Pluggable octal relay with power contacts, 3 PDT, test button, mechanical switching position indication, input voltage: 230 V AC



## Key Commercial Data

Packing unit	10 pc
Minimum order quantity	10 pc
GTIN	 4 046356 759090
GTIN	4046356759090

## Technical data

### Note

Type of note	Notes on operation
Note	The outputs are not suitable for switching different outer conductors.
Type of note	Notes on operation
Note	Do not use to separate SELV / PELV circuits from other circuits, because safe isolation is not guaranteed.

### Dimensions

Width	35 mm
Height	35 mm
Depth	54.4 mm

### Ambient conditions

Ambient temperature (operation)	-40 °C ... 55 °C
Ambient temperature (storage/transport)	-40 °C ... 85 °C
Maximum altitude	≤ 2000 m
Degree of protection	RT I
	≥ IP54 (Installation location)

### Coil side

# Single relay - REL-OR3/L-230AC/3X21 - 2903696

## Technical data

### Coil side

Nominal input voltage $U_N$	230 V AC
Mains frequency	50/60 Hz
Typical input current at $U_N$	13 mA
Typical response time	5 ms ... 15 ms (depending on phase relation)
Typical release time range	5 ms ... 20 ms (depending on phase relation)
Status display	Yellow LED
Coil resistance	7080 $\Omega$ $\pm$ 15 %
Power dissipation for nominal condition	2.99 W

### Contact side

Contact type	3 PDTs
Type of switch contact	Single contact
Contact material	AgNi
Maximum switching voltage	250 V DC
	440 V AC
Minimum switching voltage	10 V (At 24 mA)
Min. switching current	10 mA (at 24 V)
Maximum inrush current	30 A (20 ms, N/O contacts)
Limiting continuous current	10 A
Interrupting rating (ohmic load) max.	240 W (at 24 V DC)
	124 W (at 48 V DC)
	108 W (at 60 V DC)
	52 W (at 110 V DC)
	48 W (at 220 V DC)
	2500 VA (for 250 V AC)

### General

Test voltage relay winding/relay contact	2.5 kV <sub>rms</sub> (50 Hz, 1 min.)
Test voltage PDT/PDT	2.5 kV <sub>rms</sub> (50 Hz, 1 min.)
Operating mode	100% operating factor
Mechanical service life	approx. $2 \times 10^7$ cycles
Service life, electrical	see diagram
Mounting position	any

### Connection data

Connection method	Plug connection
-------------------	-----------------

### Standards and Regulations

Connection in acc. with standard	CSA
Standards/regulations	IEC 60664
	IEC 61810
Rated insulation voltage	250 V AC
Rated surge voltage	4 kV

# Single relay - REL-OR3/L-230AC/3X21 - 2903696

## Technical data

### Standards and Regulations

Insulation	Basic insulation
Pollution degree	3
Overvoltage category	III

### Environmental Product Compliance

China RoHS	Environmentally Friendly Use Period = 50 years
	For details about hazardous substances go to tab "Downloads", Category "Manufacturer's declaration"

## Drawings

Diagram

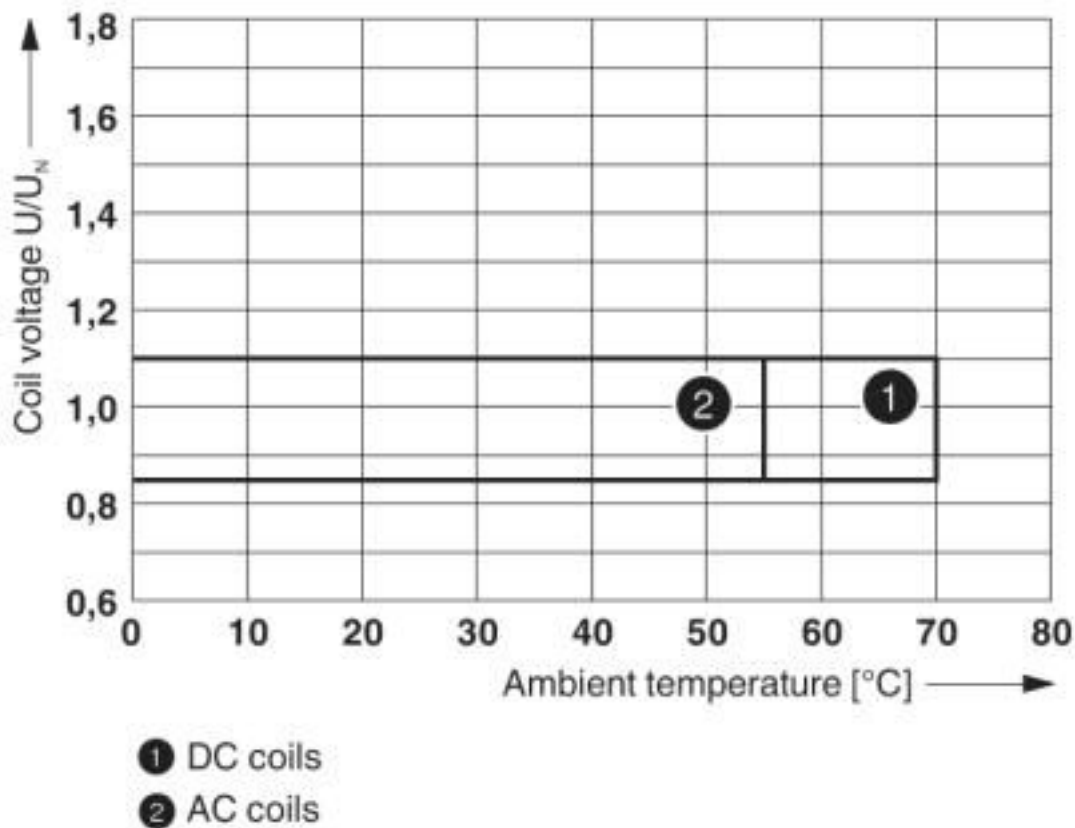

Operating voltage range

# Single relay - REL-OR3/L-230AC/3X21 - 2903696

Diagram

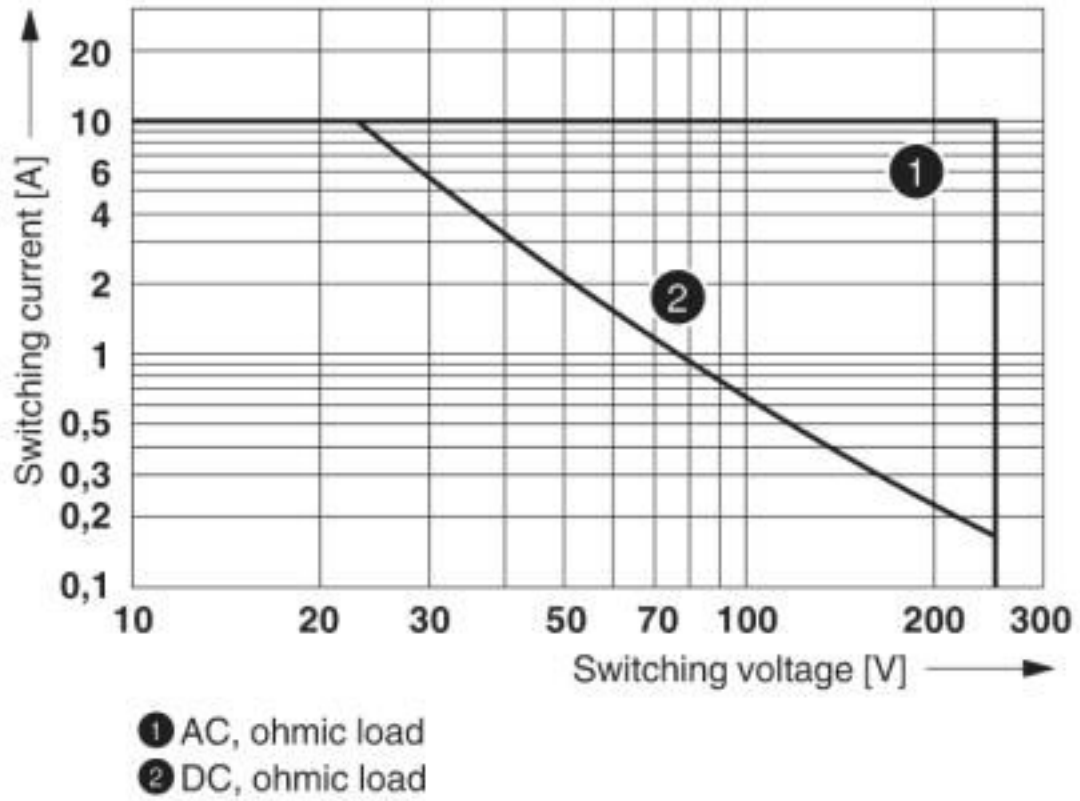

Interrupting rating

# Single relay - REL-OR3/L-230AC/3X21 - 2903696

Diagram

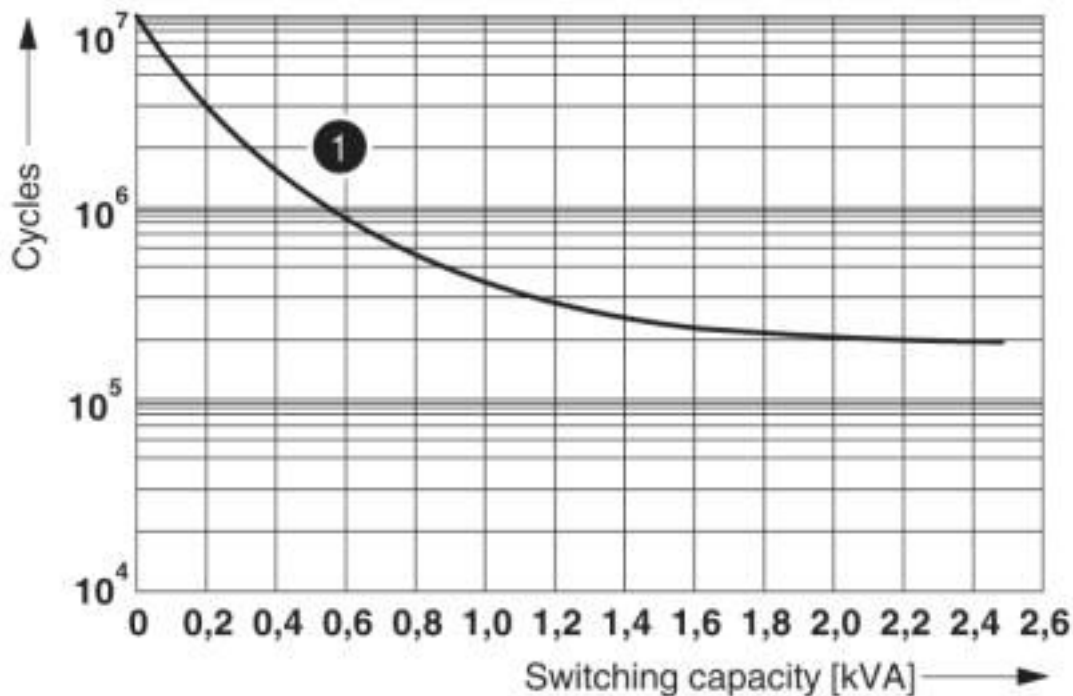

❶ 250 V AC, ohmic load

## Electrical service life

Diagram

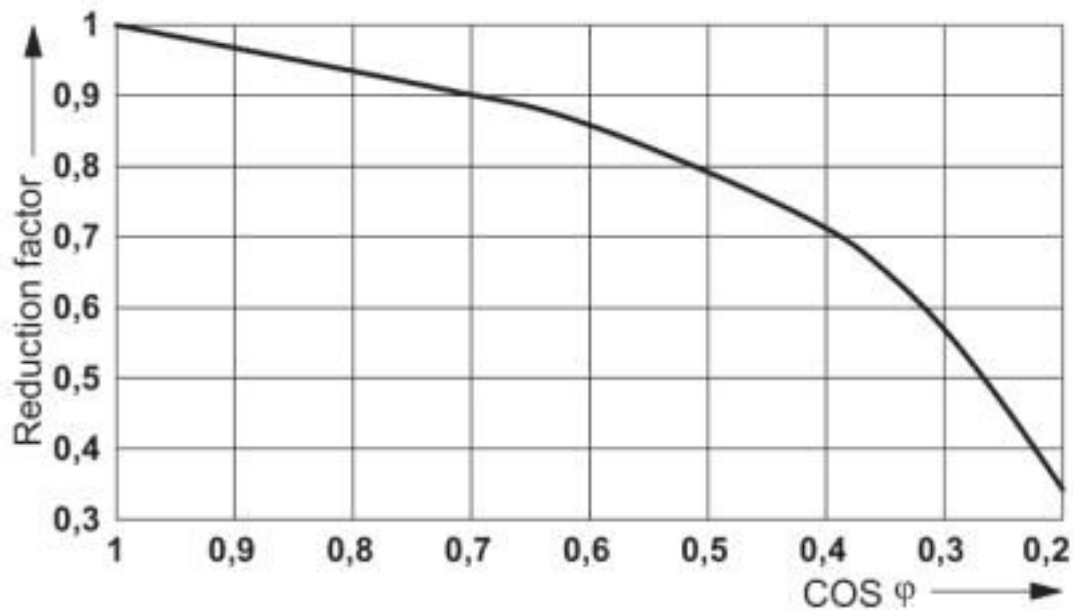

## Service life reduction factor

# Single relay - REL-OR3/L-230AC/3X21 - 2903696

Circuit diagram

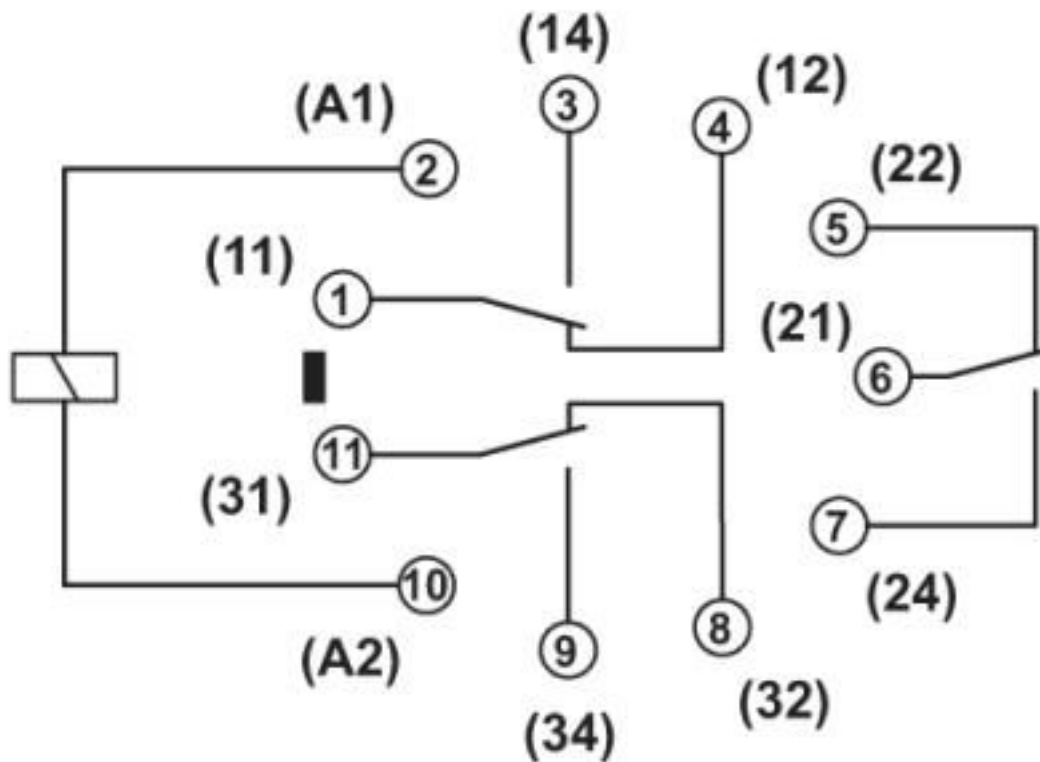

## Classifications

eCl@ss

eCl@ss 10.0.1	27371601
eCl@ss 4.0	27371100
eCl@ss 4.1	27371100
eCl@ss 5.0	27371600
eCl@ss 5.1	27371600
eCl@ss 6.0	27371600
eCl@ss 7.0	27371601
eCl@ss 8.0	27371601
eCl@ss 9.0	27371601

ETIM

ETIM 2.0	EC001437
ETIM 3.0	EC001437
ETIM 4.0	EC001437
ETIM 5.0	EC001437
ETIM 6.0	EC001437
ETIM 7.0	EC001437

# Single relay - REL-OR3/L-230AC/3X21 - 2903696

## Classifications

### UNSPSC

UNSPSC 6.01	30211916
UNSPSC 7.0901	39121515
UNSPSC 11	39121515
UNSPSC 12.01	39121515
UNSPSC 13.2	39122334
UNSPSC 18.0	39122334
UNSPSC 19.0	39122334
UNSPSC 20.0	39122334
UNSPSC 21.0	39122334

## Approvals

### Approvals

#### Approvals

CSA / UL Recognized / cUL Recognized / VDE Zeichengenehmigung / EAC / EAC / cULus Recognized

#### Ex Approvals

### Approval details

CSA		<a href="http://www.csagroup.org/services-industries/product-listing/">http://www.csagroup.org/services-industries/product-listing/</a>	2554095
-----	---	---	---------

UL Recognized		<a href="http://database.ul.com/cgi-bin/XYV/template/LISEXT/1FRAME/index.htm">http://database.ul.com/cgi-bin/XYV/template/LISEXT/1FRAME/index.htm</a>	FILE E 172140
---------------	---	---	---------------

cUL Recognized		<a href="http://database.ul.com/cgi-bin/XYV/template/LISEXT/1FRAME/index.htm">http://database.ul.com/cgi-bin/XYV/template/LISEXT/1FRAME/index.htm</a>	FILE E 172140
----------------	---	---	---------------

VDE Zeichengenehmigung		<a href="http://www2.vde.com/de/Institut/Online-Service/VDE-gepruefteProdukte/Seiten/Online-Suche.aspx">http://www2.vde.com/de/Institut/Online-Service/VDE-gepruefteProdukte/Seiten/Online-Suche.aspx</a>	40036588
------------------------	---	---	----------

EAC			TR_TS_D_00573_c
-----	---	--	-----------------

# Single relay - REL-OR3/L-230AC/3X21 - 2903696

## Approvals

EAC		RU*C- DE.*08.B.00010
-----	---	-------------------------

cULus Recognized	
------------------	---

## Accessories

### Additional products

Relay base - RIF-3-BPT/3X21 - 2900938



RIF-3... relay base, for octal relay with 3 PDTs, push-in connection, plug-in option for input/suppressor modules, for mounting on NS 35/7,5

Relay base - RIF-3-BSC/3X21 - 2900936



RIF-3... relay base, for octal relay with 3 changeover contacts, screw connection, plug-in option for input/interference suppression modules, for mounting on NS 35/7,5

Phoenix Contact 2020 © - all rights reserved  
<http://www.phoenixcontact.com>

PHOENIX CONTACT GmbH & Co. KG  
Flachsmarktstr. 8  
32825 Blomberg  
Germany  
Tel. +49 5235 300  
Fax +49 5235 3 41200  
<http://www.phoenixcontact.com>



## X-ON Electronics

Largest Supplier of Electrical and Electronic Components

*Click to view similar products for [Industrial Relays](#) category:*

*Click to view products by [Phoenix Contact](#) manufacturer:*

Other Similar products are found below :

[6-1617801-8](#) [6-1618107-9](#) [7-1618273-3](#) [EV250-4A-02](#) [EV250-6A-01](#) [FCA-125-CX8](#) [FCA-325-159](#) [FCA-410-138](#) [8000-S3121](#) [8-1618273-6](#)  
[8-1618393-1](#) [GCA63A220VAC60HZ](#) [GCA63A277VAC60HZ](#) [GCA63A600VAC60HZ](#) [1-1672275-3](#) [1-1833005-4](#) [H-16/S1](#) [A711Z](#) [H-8C](#)  
[H-8/S11](#) [H-8/S68](#) [ACC530U20](#) [ACC730U30](#) [RF303ZM4-12](#) [DH18DA](#) [1423675-8](#) [AR4-15F13-C01](#) [AR7-41F11](#) [AVR907](#) [15732A200](#)  
[B07B032AC1-0329](#) [B329](#) [B490A](#) [1618279-1](#) [BHR124Y](#) [1810DDB-SX](#) [N417](#) [P30C42A12D1-120](#) [2-1617748-6](#) [2-1618375-1](#) [2-1618396-6](#)  
[2-1618398-1](#) [JMAPD-5XL](#) [JMGACD-5M](#) [JMGSC-5LW](#) [JMGSCD-5L](#) [PBO-18A1218](#) [PBO-40A3040](#) [K8DSPH1200480VAC](#) [KA-3C-12A](#)