

Passive module - VIP-2/PT/FLK50/AB-1756 - 2904286

Please be informed that the data shown in this PDF Document is generated from our Online Catalog. Please find the complete data in the user's documentation. Our General Terms of Use for Downloads are valid (<http://phoenixcontact.com/download>)



VARIOFACE COMPACT LINE, interface module for Allen-Bradley ControlLogix, with ControlLogix-specific labeling



Key Commercial Data

Packing unit	1 pc
GTIN	 4 046356 813730
GTIN	4046356813730

Technical data

Dimensions

Width	97.7 mm
Height	72.1 mm
Depth	56 mm

Ambient conditions

Ambient temperature (operation)	-20 °C ... 50 °C
Ambient temperature (storage/transport)	-20 °C ... 70 °C

General

Max. permissible operating voltage	25 V AC
	60 V DC
Max. perm. current (per branch)	1 A
Number of positions	50
Status display	No
Mounting position	any

Connection data

Connection name	Field level
Connection method	Push-in connection

Passive module - VIP-2/PT/FLK50/AB-1756 - 2904286

Technical data

Connection data

Stripping length	8 mm
Number of positions	50
Conductor cross section solid	0.14 mm ² ... 1.5 mm ²
Conductor cross section flexible	0.14 mm ² ... 1.5 mm ²
Conductor cross section AWG	26 ... 14

Connection data 2

Connection name	Controller level
Connection method	IDC/FLK pin strip
Number of connections	1
Number of positions	50
Pitch	2.54 mm

Supported controller

Controller	ALLEN-BRADLEY ControlLogix
- suitable I/O card	1756-IA16I
	1756-IB16D
	1756-IB16I
	1756-IB32
	1756-IH16I
	1756-OB32
	1756-IF8
	1756-IF16
	1756-HSC
	1756-M02AE
Controller	HONEYWELL Experion PKS C200
- suitable I/O card	TC-IDK 161
	TC-IDX 161
	TC-IDJ 161
	TC-IDD 321
	TC-ODD 321
	TC-IAH 161

Standards and Regulations

Connection in acc. with standard	CSA
Standards/regulations	IEC 60664
	DIN EN 50178
Rated surge voltage	0.6 kV
Pollution degree	2
Overvoltage category	II
Flammability rating according to UL 94	V0

Environmental Product Compliance

Passive module - VIP-2/PT/FLK50/AB-1756 - 2904286

Technical data

Environmental Product Compliance

China RoHS	Environmentally Friendly Use Period = 50 years
	For details about hazardous substances go to tab "Downloads", Category "Manufacturer's declaration"

Drawings

Circuit diagram

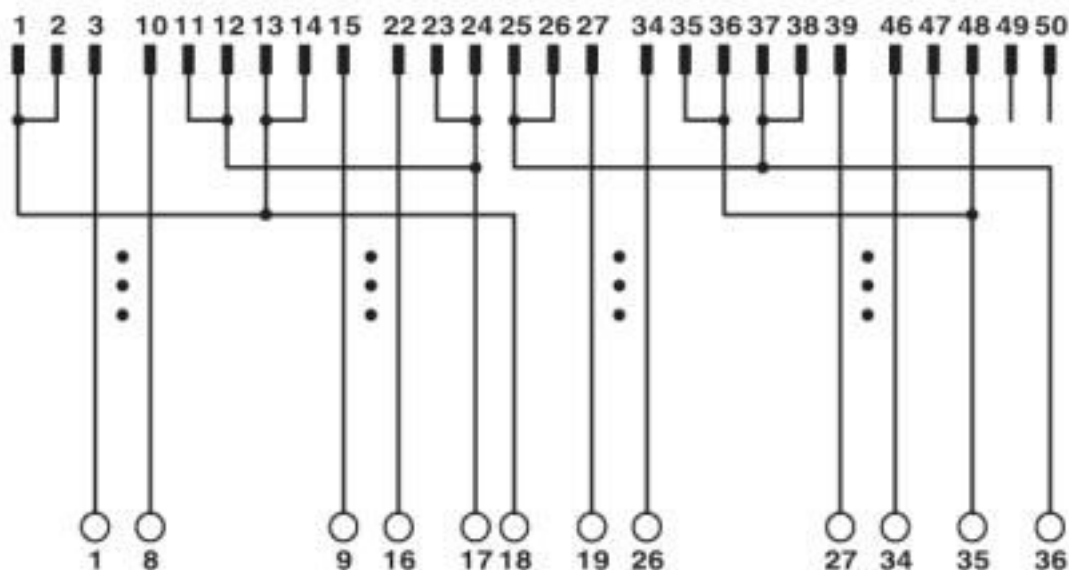

Classifications

eCl@ss

eCl@ss 10.0.1	27141152
eCl@ss 4.0	27250300
eCl@ss 4.1	27250300
eCl@ss 5.0	27250300
eCl@ss 5.1	27250300
eCl@ss 6.0	27242600
eCl@ss 7.0	27141152
eCl@ss 8.0	27141152
eCl@ss 9.0	27141152

ETIM

ETIM 4.0	EC002780
ETIM 5.0	EC002780
ETIM 6.0	EC002780
ETIM 7.0	EC002780

Passive module - VIP-2/PT/FLK50/AB-1756 - 2904286

Classifications

UNSPSC

UNSPSC 6.01	30211824
UNSPSC 7.0901	39121421
UNSPSC 11	39121421
UNSPSC 12.01	39121421
UNSPSC 13.2	39121432
UNSPSC 18.0	39121432
UNSPSC 19.0	39121432
UNSPSC 20.0	39121432
UNSPSC 21.0	39121432

Approvals

Approvals

Approvals

CSA / UL Recognized / cUL Recognized / EAC / cULus Recognized

Ex Approvals

Approval details

CSA		http://www.csagroup.org/services-industries/product-listing/	2122203
Nominal voltage UN		125 V	
Nominal current IN		1 A	
mm ² /AWG/kcmil		26-14	

UL Recognized		http://database.ul.com/cgi-bin/XYV/template/LISEXT/1FRAME/index.htm	FILE E 238705
Nominal voltage UN		125 V	
Nominal current IN		1 A	
mm ² /AWG/kcmil		26-14	

Passive module - VIP-2/PT/FLK50/AB-1756 - 2904286

Approvals

cUL Recognized		http://database.ul.com/cgi-bin/XYV/template/LISEXT/1FRAME/index.htm	FILE E 238705
----------------	---	---	---------------

Nominal voltage UN	125 V
Nominal current IN	1 A
mm ² /AWG/kcmil	26-14

EAC		RU C- DE.A*30.B.01742
-----	---	--------------------------

cULus Recognized	
------------------	---

Phoenix Contact 2020 © - all rights reserved
<http://www.phoenixcontact.com>

PHOENIX CONTACT GmbH & Co. KG
Flachsmarktstr. 8
32825 Blomberg
Germany
Tel. +49 5235 300
Fax +49 5235 3 41200
<http://www.phoenixcontact.com>

X-ON Electronics

Largest Supplier of Electrical and Electronic Components

Click to view similar products for [Terminal Block Interface Modules](#) category:

Click to view products by [Phoenix Contact](#) manufacturer:

Other Similar products are found below :

[73-551-6002I](#) [GCN1MX25B](#) [DIN-50P-01](#) [DIN-68H-01](#) [DIN-96DI-01](#) [2291901](#) [2295185](#) [2907794](#) [2M10FCL](#) [FLKM-2I/O](#) [FLKM-4I/O](#)
[2281759](#) [2906251](#) [2907808](#) [5601749](#) [5541962](#) [1776613-1](#) [GCN1-004A](#) [ADAM-3920R-AE](#) [060-6827-06](#) [2311030](#) [2287708](#) [XW2C-20G6-](#)
[IO16](#) [GCN1-T](#) [MACX](#) [MCR-VAC](#) [5775235](#) [ADAM-3956-BE](#) [XW6T-COM2.5X20YL](#) [XW6T-COM1.5X8BL](#) [XW6T-COM1.5X16BL](#)
[XW6T-COM1.5X20YL](#) [XW6T-COM1.5X16YL](#) [XW6T-COM1.5X20RD](#) [XW6T-COM1.5X20BL](#) [XW6T-COM2.5X8BL](#) [1976610000](#) [UM](#)
[45-D50SUB/B/ZFKDS](#) [5541234](#) [410-261](#) [2906243](#) [2906915](#) [2907706](#) [ADAM-3909-AE](#) [ADAM-3920-AE](#) [ADAM-3925-AE](#) [ADAM-3937-](#)
[BE](#) [ADAM-3950-AE](#) [ADAM-3951-BE](#) [ADAM-3968-AE](#) [ADAM-3968/50-AE](#)