

Fixing plate - FLT-ISG-PL-33 - 2905747

Please be informed that the data shown in this PDF Document is generated from our Online Catalog. Please find the complete data in the user's documentation. Our General Terms of Use for Downloads are valid (<http://phoenixcontact.com/download>)

Plate for fixing the FLT-ISG-100-EX isolating spark gap to a flange, drill hole diameter of 33 mm.



Key Commercial Data

Packing unit	1 pc
GTIN	 4 055626 002538
GTIN	4055626002538

Technical data

General

Mounting type	Screw mounting
Material	St/tZn

Drawings

Fixing plate - FLT-ISG-PL-33 - 2905747

Dimensional drawing

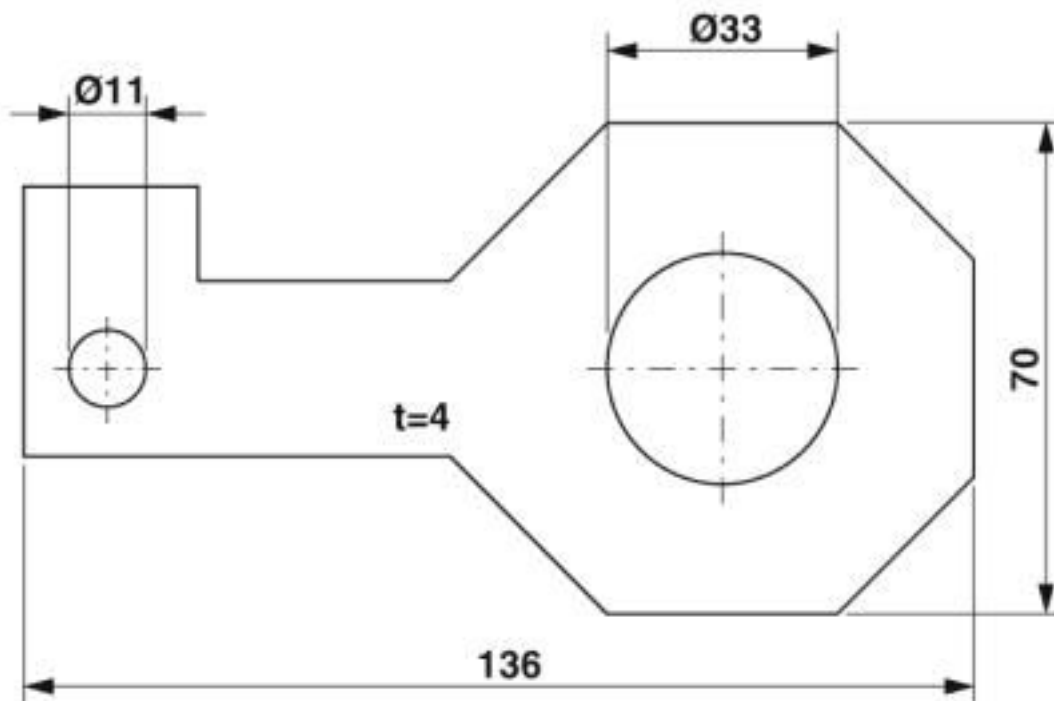

Classifications

eCl@ss

eCl@ss 10.0.1	27400563
eCl@ss 4.0	27140200
eCl@ss 4.1	27140200
eCl@ss 5.0	27140200
eCl@ss 5.1	27140200
eCl@ss 6.0	27409200
eCl@ss 7.0	27409202
eCl@ss 8.0	27409202
eCl@ss 9.0	27400563

ETIM

ETIM 5.0	EC000490
ETIM 6.0	EC000482
ETIM 7.0	EC000482

UNSPSC

UNSPSC 13.2	39121708
UNSPSC 18.0	39121708
UNSPSC 19.0	39121708
UNSPSC 20.0	39121708

Fixing plate - FLT-ISG-PL-33 - 2905747

Classifications

UNSPSC

UNSPSC 21.0	39121708
-------------	----------

Phoenix Contact 2020 © - all rights reserved
<http://www.phoenixcontact.com>

PHOENIX CONTACT GmbH & Co. KG
Flachsmarktstr. 8
32825 Blomberg
Germany
Tel. +49 5235 300
Fax +49 5235 3 41200
<http://www.phoenixcontact.com>

X-ON Electronics

Largest Supplier of Electrical and Electronic Components

Click to view similar products for [Circuit Breakers](#) category:

Click to view products by [Phoenix Contact](#) manufacturer:

Other Similar products are found below :

[LUGZX66-1-61-20.0-44](#) [M39019/01-201S](#) [M39019/01-221](#) [M39019/01-323](#) [M39019/01-333](#) [M39019/01-336](#) [M39019/02-248](#) [M39019/02-311](#) [M39019/02-316](#) [M39019/04-249S](#) [M39019/05-246S](#) [M39019/06-254S](#) [M55629/1-016](#) [M55629/1-018](#) [M55629/1-021](#) [M55629/1-033](#) [M55629/1-036](#) [M55629/1-046](#) [M55629/1-048](#) [M55629/1-058](#) [M55629/1-067](#) [M55629/1-070](#) [M55629/1-079](#) [M55629/1-084](#) [M55629/1-085](#) [M55629/1-101](#) [M55629/1-109](#) [M55629/11-102](#) [M55629/1-120](#) [M55629/12-045](#) [M55629/12-046](#) [M55629/1-330](#) [M55629/1-366](#) [M55629/1-387](#) [M55629/1-401](#) [M55629/1-450](#) [M55629/2-022](#) [M55629/2-030](#) [M55629/2-072](#) [M55629/2-082](#) [M55629/2-099](#) [M55629/2-101](#) [M55629/2-102](#) [M55629/21-BM-BM](#) [M55629/21-HM-HM](#) [M55629/21-NS-NS](#) [M55629/22-NR-NR-NR](#) [M55629/22-RS-RS-RS](#) [M55629/2-347](#) [M55629/2-401](#)