

# Loop-powered isolators - MACX MCR-SL-2I-2I-HV-ILP - 2907706

Please be informed that the data shown in this PDF Document is generated from our Online Catalog. Please find the complete data in the user's documentation. Our General Terms of Use for Downloads are valid (<http://phoenixcontact.com/download>)



Two-channel input loop-powered 2-way isolator with increased cut-off voltage and plug-in connection technology for the electrical isolation of analog signals. Input signal = output signal: 0(4) mA ... 20 mA. Screw connection technology

## Product Description

Two-channel input-loop-powered 2-way isolator with increased cut-off voltage and plug-in connection technology for the electrical isolation and filtering of analog signals. The input-loop-powered isolator allows operation with active sensor technology with a supply voltage of 6 V DC to 30 V DC. The device is powered via the current loop of the sensor. Input signal = output signal: 0(4) mA to 20 mA. With screw connection.



## Key Commercial Data

Packing unit	1 pc
GTIN	 4 055626 219264
GTIN	4055626219264

## Technical data

### Dimensions

Width	12.5 mm
Height	112.5 mm
Depth	113.7 mm

### Ambient conditions

Ambient temperature (operation)	-40 °C ... 85 °C
Ambient temperature (storage/transport)	-40 °C ... 85 °C
Maximum altitude	< 2000 m
Permissible humidity (operation)	5 % ... 95 % (non-condensing)
Degree of protection	IP20 (not assessed by UL)
Noise immunity	EN 61326-1

### Input data

Signal input	Current input
Configurable/programmable	no

# Loop-powered isolators - MACX MCR-SL-2I-2I-HV-ILP - 2907706

## Technical data

### Input data

Max. voltage input signal	< 30.5 V
Current input signal	0 mA ... 20 mA
	4 mA ... 20 mA
Input voltage limitation	30.5 V
Voltage dissipation	2.9 V (I = 20 mA)
Step response (10-90%)	5 ms (500 Ω load)

### Output data

Signal output	Current output
Configurable/programmable	no
Max. voltage output signal	27.5 V
Current output signal	0 mA ... 20 mA
	4 mA ... 20 mA
Transmission Behavior	1:1 to input signal
Load/output load current output	≤ 1375 Ω (I = 20 mA)
Residual ripple	< 10 mV <sub>rms</sub> (500 Ω load)

### Power supply

Supply voltage range	no separate supply voltage necessary
----------------------	--------------------------------------

### Connection data

Connection method	Screw connection
Stripping length	7 mm
Conductor cross section solid	0.2 mm <sup>2</sup> ... 2.5 mm <sup>2</sup>
Conductor cross section flexible	0.2 mm <sup>2</sup> ... 2.5 mm <sup>2</sup>
Conductor cross section AWG	24 ... 14
Torque	0.5 Nm ... 0.6 Nm

### Connection data 2

Connection name	Test socket
Max. diameter	2.3 mm

### General

No. of channels	2
Maximum transmission error	≤ 0.1 % (of final value)
Maximum temperature coefficient	≤ 0.002 %/K (of measured value / 100 Ω load)
Degree of pollution	2
Overvoltage category	II
Electromagnetic compatibility	Conformance with EMC directive
Interference emission	EN 61000-6-4
Housing material	PA 6.6-FR
Color	gray
Designation	Input/output/power supply

# Loop-powered isolators - MACX MCR-SL-2I-2I-HV-ILP - 2907706

## Technical data

### Standards and Regulations

Electromagnetic compatibility	Conformance with EMC directive
Noise emission	EN 61000-6-4
Noise immunity	EN 61326-1
Conformance	CE-compliant, additionally EN 61326-1
ATEX	# II 3 G Ex nA IIC T4 Gc X
UL, USA/Canada	UL 61010 Listed
	Class I, Div. 2, Groups A, B, C, D T4
	Class I, Zone 2, Group IIC T4

### Conformance/approvals

Designation	CE
Identification	CE-compliant
Additional text	and EN 61326-1
Designation	ATEX
Identification	# II 3 G Ex nA IIC T4 Gc X
Designation	UL, USA/Canada
Identification	UL 61010 Listed
	Class I, Div. 2, Groups A, B, C, D T4
	Class I, Zone 2, Group IIC T4
Designation	Safety Integrity Level (SIL, IEC 61508)
Identification	3
Certificate	968/FSP 1200.00/15

### Environmental Product Compliance

REACH SVHC	Lead 7439-92-1
China RoHS	Environmentally Friendly Use Period = 50 years
	For details about hazardous substances go to tab "Downloads", Category "Manufacturer's declaration"

## Drawings

# Loop-powered isolators - MACX MCR-SL-2I-2I-HV-ILP - 2907706

Block diagram

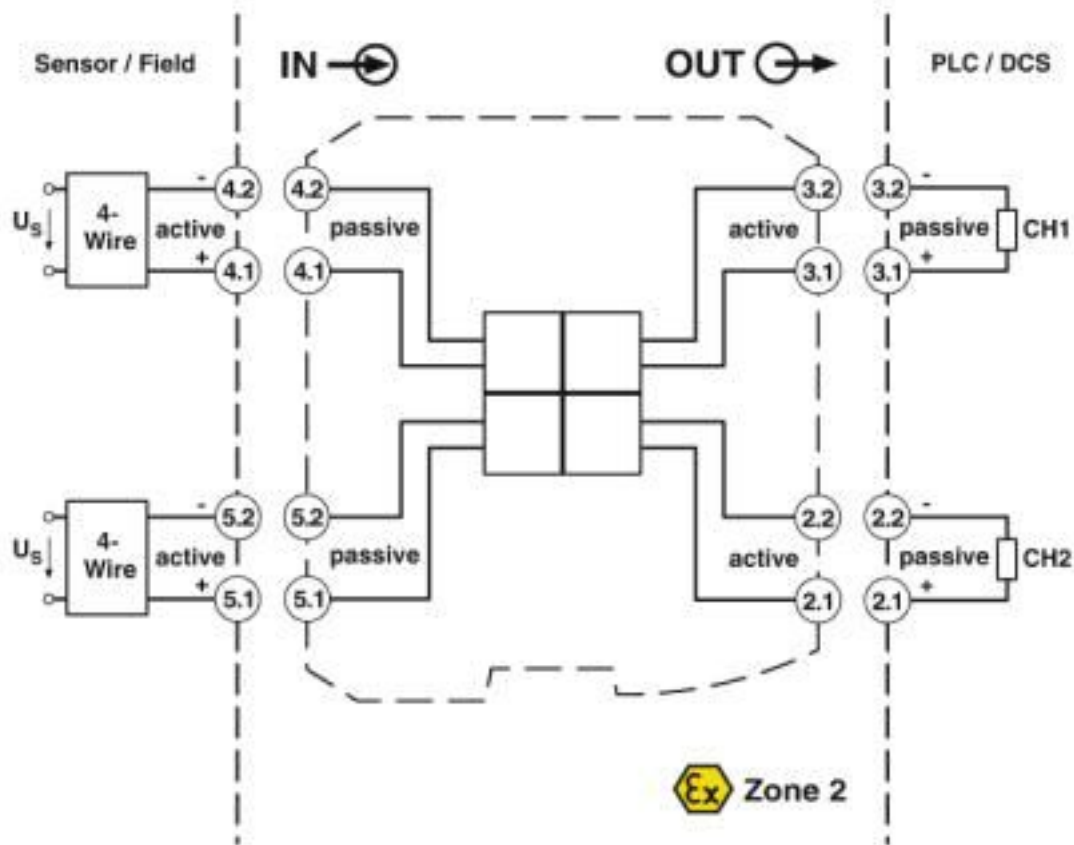

Pictogram

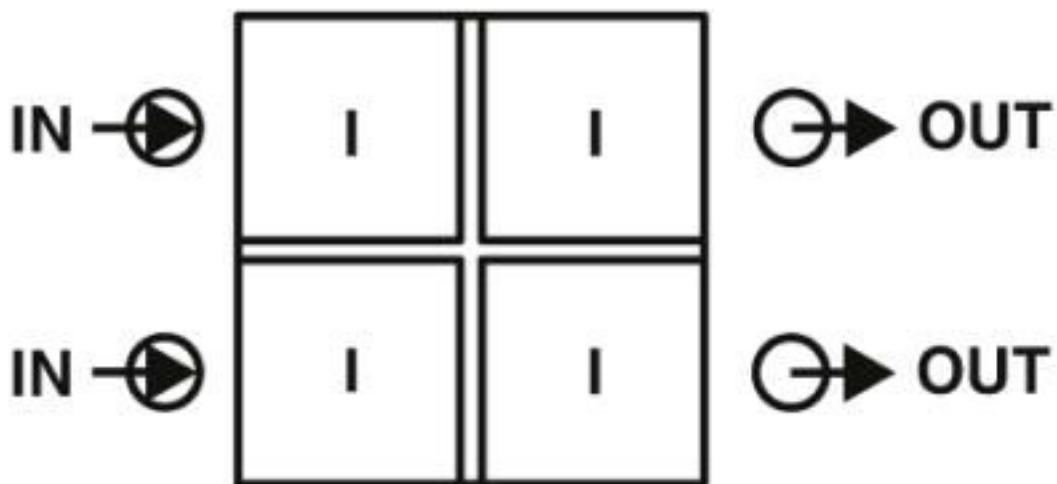

# Loop-powered isolators - MACX MCR-SL-2I-2I-HV-ILP - 2907706

## Classifications

### eCl@ss

eCl@ss 10.0.1	27210120
eCl@ss 4.0	27210100
eCl@ss 4.1	27210100
eCl@ss 5.0	27210100
eCl@ss 5.1	27210100
eCl@ss 6.0	27210100
eCl@ss 7.0	27210120
eCl@ss 8.0	27210120
eCl@ss 9.0	27210120

### ETIM

ETIM 4.0	EC002653
ETIM 5.0	EC002653
ETIM 6.0	EC002653
ETIM 7.0	EC002653

### UNSPSC

UNSPSC 13.2	39121008
UNSPSC 18.0	39121008
UNSPSC 19.0	39121008
UNSPSC 20.0	39121008
UNSPSC 21.0	39121008

## Approvals

### Approvals

#### Approvals

UL Listed / cUL Listed / Functional Safety / EAC / cULus Listed

#### Ex Approvals





ATEX / UL Recognized / cUL Recognized / cULus Recognized

### Approval details

UL Listed		<a href="http://database.ul.com/cgi-bin/XYVV/template/LISEXT/1FRAME/index.htm">http://database.ul.com/cgi-bin/XYVV/template/LISEXT/1FRAME/index.htm</a>	FILE E 330267
-----------	---	---	---------------

## Loop-powered isolators - MACX MCR-SL-2I-2I-HV-ILP - 2907706

### Approvals

cUL Listed		<a href="http://database.ul.com/cgi-bin/XYV/template/LISEXT/1FRAME/index.htm">http://database.ul.com/cgi-bin/XYV/template/LISEXT/1FRAME/index.htm</a>	FILE E 330267
Functional Safety			968/FSP 1200.00/15
EAC			RU*DE.*08.B.01608/19
cULus Listed			

Phoenix Contact 2020 © - all rights reserved  
<http://www.phoenixcontact.com>

PHOENIX CONTACT GmbH & Co. KG  
Flachsmarktstr. 8  
32825 Blomberg  
Germany  
Tel. +49 5235 300  
Fax +49 5235 3 41200  
<http://www.phoenixcontact.com>

## X-ON Electronics

Largest Supplier of Electrical and Electronic Components

*Click to view similar products for [Terminal Block Interface Modules](#) category:*

*Click to view products by [Phoenix Contact](#) manufacturer:*

Other Similar products are found below :

[73-551-6002I](#) [GCN1MX25B](#) [DIN-50P-01](#) [DIN-68H-01](#) [DIN-96DI-01](#) [2291901](#) [2295185](#) [2907794](#) [2M10FCL](#) [FLKM-2I/O](#) [FLKM-4I/O](#)  
[2281759](#) [2906251](#) [2907808](#) [5601749](#) [5541962](#) [1776613-1](#) [GCN1-004A](#) [ADAM-3920R-AE](#) [060-6827-06](#) [2311030](#) [2287708](#) [XW2C-20G6-](#)  
[IO16](#) [GCN1-T](#) [MACX](#) [MCR-VAC](#) [5775235](#) [ADAM-3956-BE](#) [XW6T-COM2.5X20YL](#) [XW6T-COM1.5X8BL](#) [XW6T-COM1.5X16BL](#)  
[XW6T-COM1.5X20YL](#) [XW6T-COM1.5X16YL](#) [XW6T-COM1.5X20RD](#) [XW6T-COM1.5X20BL](#) [XW6T-COM2.5X8BL](#) [1976610000](#) [UM](#)  
[45-D50SUB/B/ZFKDS](#) [5541234](#) [410-261](#) [2906243](#) [2906915](#) [2907706](#) [ADAM-3909-AE](#) [ADAM-3920-AE](#) [ADAM-3925-AE](#) [ADAM-3937-](#)  
[BE](#) [ADAM-3950-AE](#) [ADAM-3951-BE](#) [ADAM-3968-AE](#) [ADAM-3968/50-AE](#)