

Surge protection plug - TTC-6P-2X1-48DC-I-P - 2907844

Please be informed that the data shown in this PDF Document is generated from our Online Catalog. Please find the complete data in the user's documentation. Our General Terms of Use for Downloads are valid (<http://phoenixcontact.com/download>)



Surge protection plug with integrated status indicator on the module for two signal wires with a common reference potential. Nominal voltage: 48 V DC



Key Commercial Data

Packing unit	1 pc
GTIN	 4 055626 634722
GTIN	4055626634722

Technical data

Dimensions

Height	39 mm
Width	6.2 mm +0.1 mm
Depth	60.3 mm

Ambient conditions

Ambient temperature (operation)	-40 °C ... 85 °C
Ambient temperature (storage/transport)	-40 °C ... 85 °C
Permissible humidity (operation)	5 % ... 95 %
Altitude	≤ 4000 m (amsl (above mean sea level))
Degree of protection	IP20

General

Housing material	PBT
Flammability rating according to UL 94	V-0
Color	light grey RAL 7035
Mounting type	on base element
Type	Male

Protective circuit

Surge protection plug - TTC-6P-2X1-48DC-I-P - 2907844

Technical data

Protective circuit

Nominal voltage U_N	48 V DC
Maximum continuous voltage U_C	53 V DC
Rated current	220 mA (75 °C)

Connection data

Connection method	pluggable
-------------------	-----------

Standards and Regulations

Standards/specifications	EN 61643-21 2001 + A1:2009 + A2:2013
	IEC 61643-21 2000 + corrigendum 2001 + A1:2008, modified + A2:2012

Environmental Product Compliance

REACH SVHC	Lead 7439-92-1
China RoHS	Environmentally Friendly Use Period = 50 years
	For details about hazardous substances go to tab "Downloads", Category "Manufacturer's declaration"

Drawings

Dimensional drawing

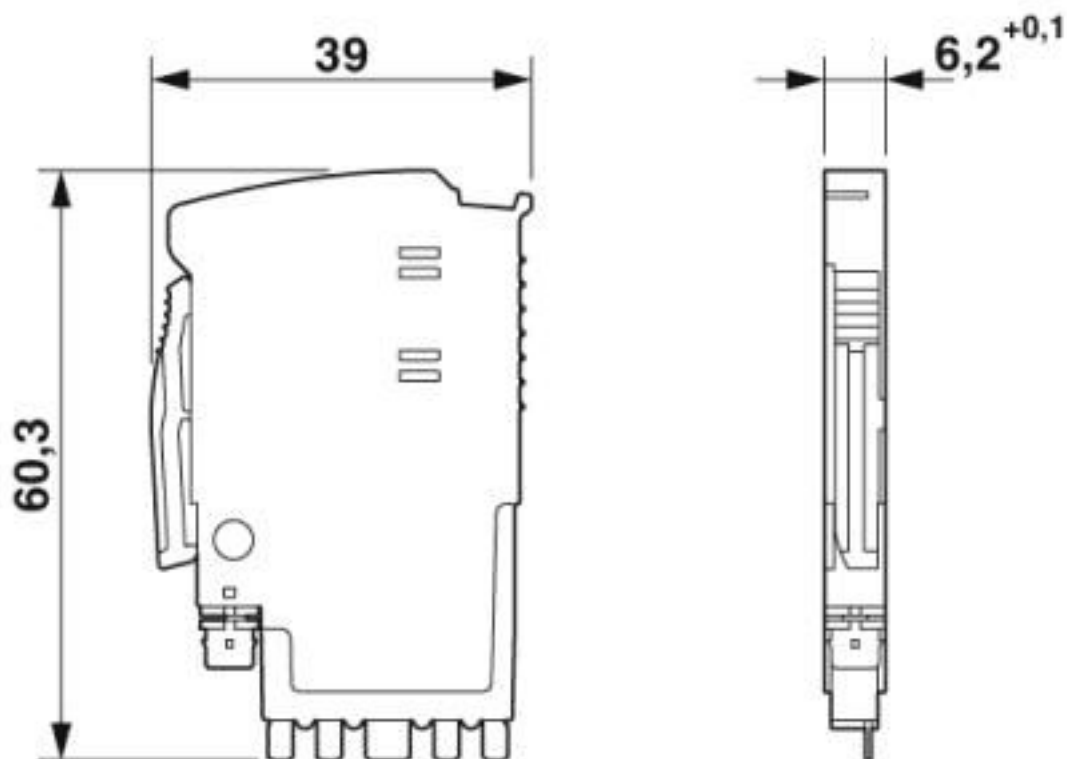

Surge protection plug - TTC-6P-2X1-48DC-I-P - 2907844

Circuit diagram

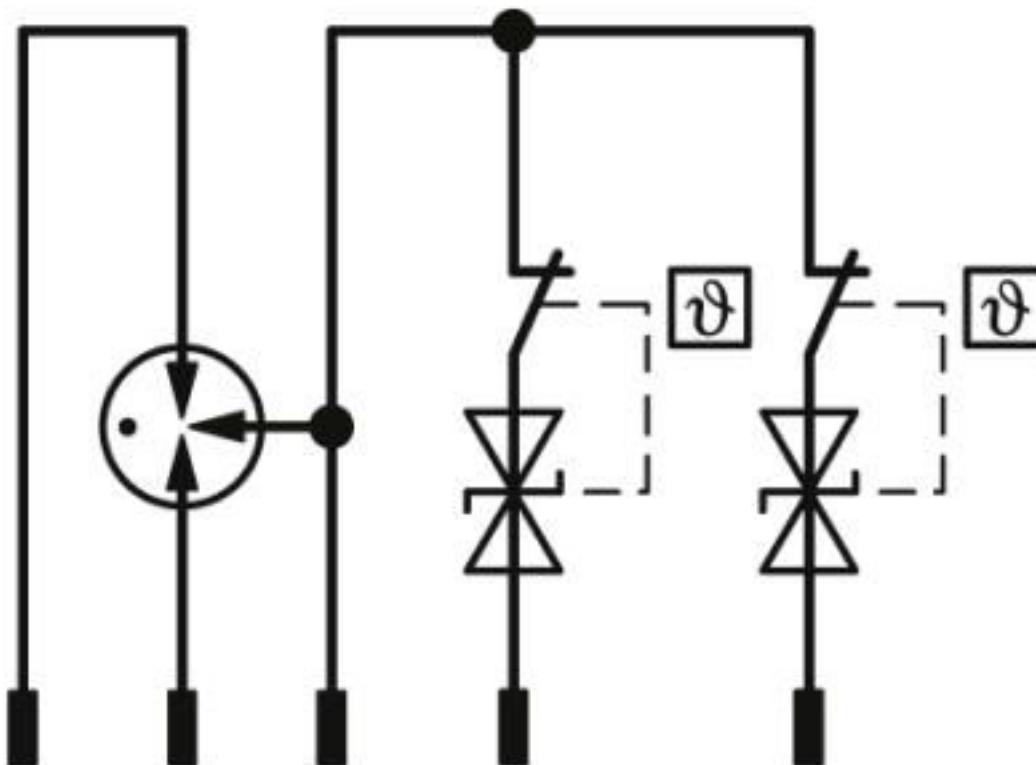

Classifications

eCl@ss

eCl@ss 10.0.1	27130890
eCl@ss 6.0	27130800
eCl@ss 7.0	27130890
eCl@ss 8.0	27130890
eCl@ss 9.0	27130890

ETIM

ETIM 5.0	EC002496
ETIM 6.0	EC002497
ETIM 7.0	EC002497

Approvals

Approvals

Approvals

DNV GL / CSA / UL Listed / CSAus / cCSAus

Surge protection plug - TTC-6P-2X1-48DC-I-P - 2907844

Approvals

Ex Approvals

Approval details

DNV GL		https://approvalfinder.dnvgl.com/	TAE000027G
CSA		http://www.csagroup.org/services-industries/product-listing/	70136717
UL Listed		http://database.ul.com/cgi-bin/XYV/template/LISEXT/1FRAME/index.htm	FILE E 138168
CSAus		http://www.csagroup.org/services-industries/product-listing/	70136717
cCSAus			

Accessories

Accessories

Labeled terminal marker

Zack Marker strip, flat - ZBF 6 CUS - 0825027



Zack Marker strip, flat, Strip, can be ordered: Strip, white, labeled according to customer specifications, mounting type: snap into flat marker groove, for terminal block width: 6.2 mm, lettering field size: 5.15 x 6.15 mm, Number of individual labels: 10

Zack Marker strip, flat - ZBF 6,QR:FORTL.ZAHLEN - 0808765



Zack Marker strip, flat, Strip, white, labeled, Printed vertically: consecutive numbers 1 ... 10, 11 ... 20, etc. up to 91 ... 100, mounting type: snap into flat marker groove, for terminal block width: 6.2 mm, lettering field size: 5.15 x 6.15 mm, Number of individual labels: 10

Surge protection plug - TTC-6P-2X1-48DC-I-P - 2907844

Accessories

Marker pen

Marker pen - X-PEN 0,35 - 0811228



Marker pen without ink cartridge, for manual labeling of markers, labeling extremely wipe-proof, line thickness 0.35 mm

Terminal marking

Zack Marker strip, flat - ZBF 6:UNBEDRUCKT - 0808710



Zack Marker strip, flat, Strip, white, unlabeled, can be labeled with: PLOTMARK, CMS-P1-PLOTTER, mounting type: snap into flat marker groove, for terminal block width: 6.2 mm, lettering field size: 5.15 x 6.15 mm, Number of individual labels: 10

Zack Marker strip, flat - ZBF 6/WH-100:UNBEDRUCKT - 0808736



Zack Marker strip, flat, Strip, white, unlabeled, can be labeled with: PLOTMARK, CMS-P1-PLOTTER, mounting type: snap into flat marker groove, for terminal block width: 6.2 mm, lettering field size: 5.15 x 6.15 mm, Number of individual labels: 10

Phoenix Contact 2020 © - all rights reserved
<http://www.phoenixcontact.com>

PHOENIX CONTACT GmbH & Co. KG
Flachsmarktstr. 8
32825 Blomberg
Germany
Tel. +49 5235 300
Fax +49 5235 3 41200
<http://www.phoenixcontact.com>

X-ON Electronics

Largest Supplier of Electrical and Electronic Components

Click to view similar products for [Surge Suppressors](#) category:

Click to view products by [Phoenix Contact](#) manufacturer:

Other Similar products are found below :

[GUS1](#) [GUS12](#) [BSPM1A600D600LVR](#) [2800521](#) [29-2053](#) [GUS11](#) [GUS2](#) [GUS3](#) [GUS4](#) [30460](#) [SRA64C060X](#) [PC642C015](#) [1810-15-A3](#)
[2713175](#) [4B06B-EC1-150LF](#) [SRA6LC](#) [BPMA75D100LV](#) [CX06M](#) [CCTV1](#) [GUS13](#) [GUS14](#) [GUS5](#) [GUS6](#) [VAL-MS 320/3+0-FM](#) [VAL-US-](#)
[120/40/1+1-FM](#) [VAL-US-120/65/1+1-FM](#) [VAL-US-480D/30/3+0-FM](#) [VAL-US-120/40/1+0-FM](#) [STCHSP121BT1RU](#) [LP-BFDN-CW](#) [LP-](#)
[STRL-NFF](#) [LP-STRL-DFE](#) [GUS22](#) [0804111](#) [5053609](#) [5053201](#) [SPD2-150-1P0](#) [SPD2-550-1P0](#) [6720005416](#) [6720005417](#) [1-2191595-2](#)
[STC-CAT6-P0E-I](#) [SPD2-350-1P0](#) [FLT-CP-350-ST](#) [TTC-6P-3-HF-F-M-12DC-UT-I](#) [SMTPA200](#) [2800989](#) [2906776](#) [2906810](#) [2906847](#)