

Power supply unit - QUINT4-PS/1AC/24DC/2.5/PT - 2909576

Please be informed that the data shown in this PDF Document is generated from our Online Catalog. Please find the complete data in the user's documentation. Our General Terms of Use for Downloads are valid (<http://phoenixcontact.com/download>)



Primary-switched power supply unit, QUINT POWER, Push-in connection, DIN rail mounting, input: 1-phase, output: 24 V DC / 2.5 A

Product Description

In the power range of up to 100 W, QUINT POWER provides superior system availability in the smallest size. Preventative function monitoring and exceptional power reserves are available for applications in the low-power range.

Your advantages

- ✓ Starting of heavy loads with dynamic boost
- ✓ Preventive function monitoring indicates critical operating states before errors occur
- ✓ High efficiency and long service life, with low power dissipation and low heating
- ✓ Space savings in the control cabinet, thanks to a narrow, slim-line design
- ✓ Free selection between Push-in and screw connection



Key Commercial Data

Packing unit	1 pc
GTIN	 4 055626 356495
GTIN	4055626356495

Technical data

Dimensions

Width	32 mm
Height	106 mm
Depth	90 mm
Installation distance right/left	0 mm / 0 mm
Installation distance top/bottom	30 mm / 30 mm

Ambient conditions

Degree of protection	IP20
Inflammability class in acc. with UL 94 (housing / terminal blocks)	V0

Power supply unit - QUINT4-PS/1AC/24DC/2.5/PT - 2909576

Technical data

Ambient conditions

Ambient temperature (operation)	-25 °C ... 70 °C (> 60 °C Derating: 2.5 %/K)
Ambient temperature (start-up type tested)	-40 °C
Ambient temperature (storage/transport)	-40 °C ... 85 °C
Max. permissible relative humidity (operation)	≤ 95 % (at 25 °C, non-condensing)
Climatic class	3K3 (in acc. with EN 60721)
Degree of pollution	2
Installation height	≤ 5000 m (> 2000 m, observe derating)

Input data

Input voltage range	100 V AC ... 240 V AC -15 % ... +10 % 110 V DC ... 250 V DC -20 % ... +40 %
Dielectric strength maximum	300 V AC 30 s
Frequency range (f _N)	50 Hz ... 60 Hz -10 % ... +10 %
Discharge current to PE	< 0.25 mA (264 V AC, 60 Hz)
Current consumption	0.85 A (100 V AC) 0.7 A (120 V AC) 0.39 A (230 V AC) 0.37 A (240 V AC)
Nominal power consumption	71 VA
Inrush current	typ. 10 A (at 25 °C)
Mains buffering time	typ. 54 ms (120 V AC) typ. 54 ms (230 V AC)
Input fuse	3.15 A (slow-blow, internal)
Type of protection	Transient surge protection
Protective circuit/component	Varistor

Output data

Nominal output voltage	24 V DC
Setting range of the output voltage (U _{Set})	24 V DC ... 28 V DC (constant capacity)
Nominal output current (I _N)	2.5 A
Static Boost (I _{Stat.Boost})	3.125 A (≤ 40 °C)
Dynamic Boost (I _{Dyn.Boost})	5 A (≤ 60 °C (5 s), Input < 150 V AC Derating 0.5 %/V)
Derating	> 60 °C (2.5%/K)
Connection in parallel	Yes, for redundancy and increased capacity
Connection in series	yes
Feedback voltage resistance	≤ 35 V DC
Protection against overvoltage at the output (OVP)	≤ 32 V DC
Control deviation	< 0.5 % (Static load change 10 % ... 90 %) < 2 % (Dynamic load change 10 % ... 90 %, (10 Hz)) < 0.1 % (change in input voltage ± 10 %)
Residual ripple	< 40 mV _{PP} (with nominal values)

Power supply unit - QUINT4-PS/1AC/24DC/2.5/PT - 2909576

Technical data

Output data

Output power	60 W
Typical response time	500 ms
Maximum power dissipation in no-load condition	< 1 W (230 V AC)
	< 1 W (120 V AC)
Power loss nominal load max.	< 5 W (230 V AC)
	< 5 W (120 V AC)

General

Net weight	0.244 kg
Efficiency	typ. 91.9 % (120 V AC)
	typ. 92.6 % (230 V AC)
MTBF (IEC 61709, SN 29500)	> 1347000 h (25 °C)
	> 734000 h (40 °C)
	> 295000 h (60 °C)
Insulation voltage input/output	4 kV AC (type test)
	3 kV AC (routine test)
Degree of protection	IP20
Protection class	II
Inflammability class in acc. with UL 94 (housing / terminal blocks)	V0
Assembly instructions	DIN rail mounting

Connection data, input

Connection method	Push-in connection
Conductor cross section solid min.	0.2 mm ²
Conductor cross section solid max.	2.5 mm ²
Conductor cross section flexible min.	0.2 mm ²
Conductor cross section flexible max.	2.5 mm ²
Conductor cross section AWG min.	24
Conductor cross section AWG max.	14
Stripping length	10 mm

Connection data, output

Connection method	Push-in connection
Conductor cross section solid min.	0.2 mm ²
Conductor cross section solid max.	2.5 mm ²
Conductor cross section flexible min.	0.2 mm ²
Conductor cross section flexible max.	2.5 mm ²
Conductor cross section AWG min.	24
Conductor cross section AWG max.	14
Stripping length	10 mm

Connection data for signaling

Connection method	Push-in connection
-------------------	--------------------

Power supply unit - QUINT4-PS/1AC/24DC/2.5/PT - 2909576

Technical data

Connection data for signaling

Conductor cross section solid min.	0.2 mm ²
Conductor cross section solid max.	2.5 mm ²
Conductor cross section flexible min.	0.2 mm ²
Conductor cross section flexible max.	2.5 mm ²
Conductor cross section AWG min.	24
Conductor cross section AWG max.	14
Stripping length	10 mm

Standards

EMC requirements for noise immunity	EN 61000-6-1
	EN 61000-6-2
EMC requirements for noise emission	EN 61000-6-3
	EN 61000-6-4
Standard - Safety of transformers	EN 61558-2-16
Standard - Electrical safety	IEC 61010-2-201 (SELV)
Standard - safety for equipment for measurement, control, and laboratory use	IEC 61010-1
Standard – Safety extra-low voltage	IEC 61010-1 (SELV)
	IEC 61010-2-201 (PELV)
Standard - Safe isolation	IEC 61558-2-16
Standard - power supply devices for low voltage with DC output	EN 61204-3
Standard – Limitation of mains harmonic currents	EN 61000-3-2

Conformance/approvals

UL approvals	UL Listed UL 61010-1
	UL Listed UL 61010-2-201
	UL 1310 Class 2 Power Units
	ANSI/UL 121201 Class I, Division 2, Groups A, B, C, D (Hazardous Location)
SIQ	CB-Scheme (IEC 61010-1, IEC 61010-2-201)

EMC data

Electromagnetic compatibility	Conformance with EMC Directive 2014/30/EU
Conducted noise emission	EN 55016
	EN 61000-6-3 (Class B)
Noise emission	EN 55016
	EN 61000-6-3 (Class B)
Electrostatic discharge	EN 61000-4-2
Contact discharge	8 kV (Test Level 4)
Discharge in air	8 kV (Test Level 3)
Electromagnetic HF field	EN 61000-4-3
Frequency range	80 MHz ... 1 GHz
Test field strength	20 V/m

Power supply unit - QUINT4-PS/1AC/24DC/2.5/PT - 2909576

Technical data

EMC data

Frequency range	1 GHz ... 6 GHz
Test field strength	10 V/m (Test Level 3)
Comments	Criterion A
Fast transients (burst)	EN 61000-4-4
Input	4 kV (Test Level 4 - asymmetrical)
Output	4 kV (Test Level 4 - asymmetrical)
Signal	4 kV (Test Level 4 - asymmetrical)
Comments	Criterion B
Surge voltage load (surge)	EN 61000-4-5
Input	2 kV (Test Level 4 - symmetrical)
	4 kV (Test Level 4 - asymmetrical)
Output	1 kV (Test Level 3 - symmetrical)
	2 kV (Test Level 3 - asymmetrical)
Signal	2 kV (Test Level 4 - symmetrical)
Comments	Criterion A
Conducted interference	EN 61000-4-6
I/O/S	asymmetrical
Frequency range	0.15 MHz ... 80 MHz
Voltage	10 V (Test Level 3)
Comments	Criterion A
Power frequency magnetic field	EN 61000-4-8
Frequency	16.67 Hz
	50 Hz
	60 Hz
Test field strength	100 A/m
Additional text	60 s
Comments	Criterion A
Frequency	50 Hz
	60 Hz
Test field strength	1 kA/m
Additional text	3 s
Frequency	0 Hz
Test field strength	300 A/m
Additional text	DC, 60 s
Voltage dips	EN 61000-4-11
Voltage	100 V AC
Frequency	60 Hz
Voltage dip	70 %
Number of periods	0.5 / 1 / 25 periods
Additional text	Test Level 2

Power supply unit - QUINT4-PS/1AC/24DC/2.5/PT - 2909576

Technical data

EMC data

Comments	Criterion B
Voltage dip	40 %
Number of periods	5 / 10 / 50 periods
Additional text	Test Level 2
Comments	Criterion B
Voltage dip	0 %
Number of periods	0.5 / 1 / 5 / 50 periods
Additional text	Test Level 2
Comments	Criterion B
Pulse-shape magnetic field	EN 61000-4-9
Test field strength	1000 A/m
Comments	Criterion A
Attenuated sinusoidal oscillations (ring wave)	EN 61000-4-12
Input	2 kV (symmetrical)
	4 kV (asymmetrical)
Comments	Criterion B
Asymmetrical conducted disturbance variables	EN 61000-4-16
Test level 1	16.67 Hz 50 Hz 60 Hz (Test Level 3)
Voltage	30 V (Permanent)
Test level 2	16.67 Hz 50 Hz 60 Hz (Test Level 4)
Voltage	300 V (1 s)
Comments	Criterion A
Attenuated oscillating wave	EN 61000-4-18
Comments	Criterion B
Criterion A	Normal operating behavior within the specified limits.
Criterion B	Temporary impairment to operational behavior that is corrected by the device itself.
Criterion C	Temporary adverse effects on the operating behavior, which the device corrects automatically or which can be restored by actuating the operating elements.

Environmental Product Compliance

China RoHS	Environmentally Friendly Use Period = 25;
	For details about hazardous substances go to tab "Downloads", Category "Manufacturer's declaration"

Drawings

Power supply unit - QUINT4-PS/1AC/24DC/2.5/PT - 2909576

Dimensional drawing

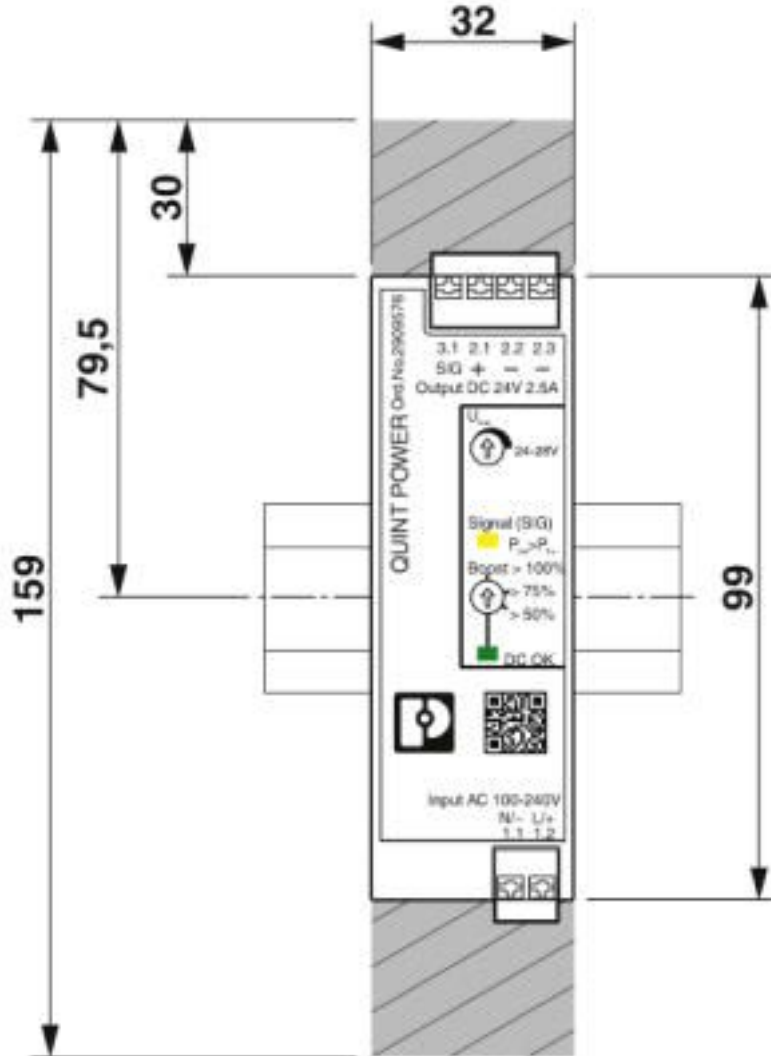

Power supply unit - QUINT4-PS/1AC/24DC/2.5/PT - 2909576

Schematic diagram

Housing

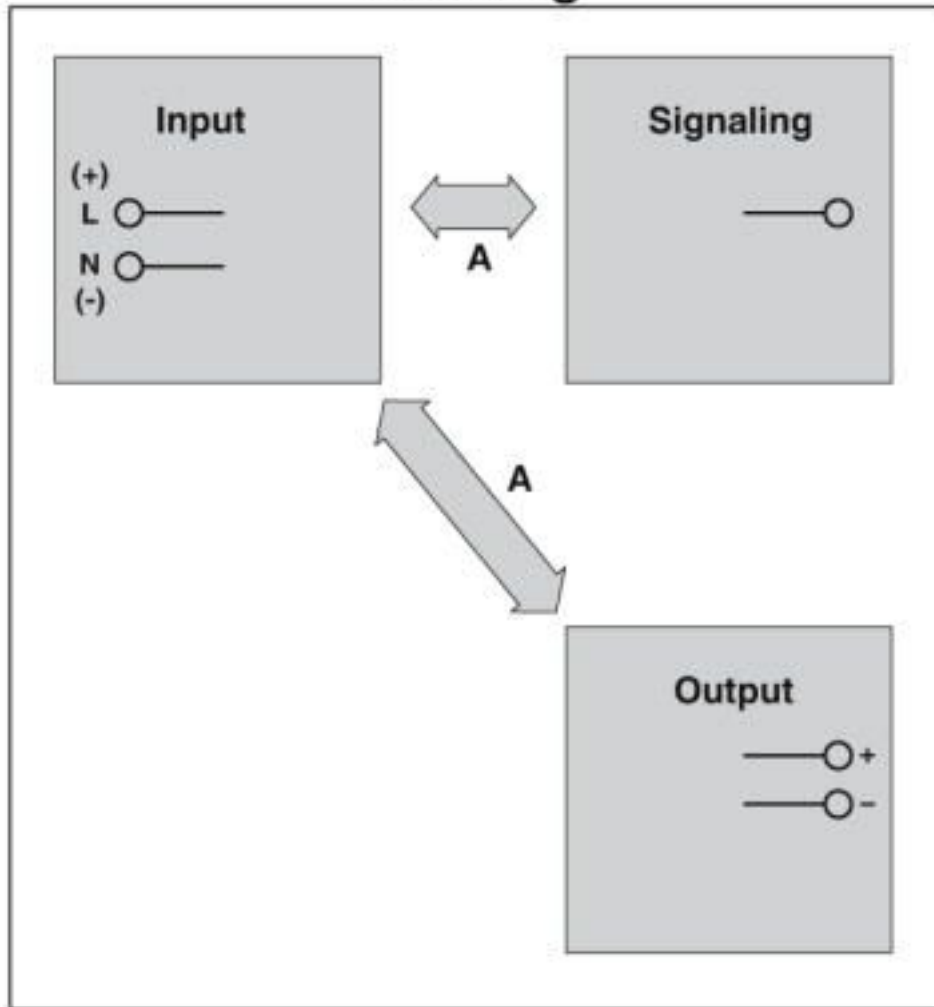

Block diagram

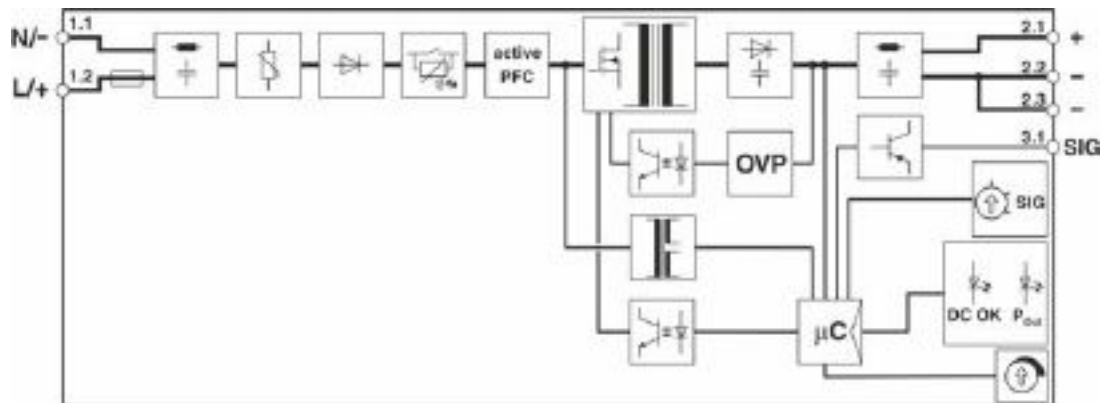

Power supply unit - QUINT4-PS/1AC/24DC/2.5/PT - 2909576

Diagram

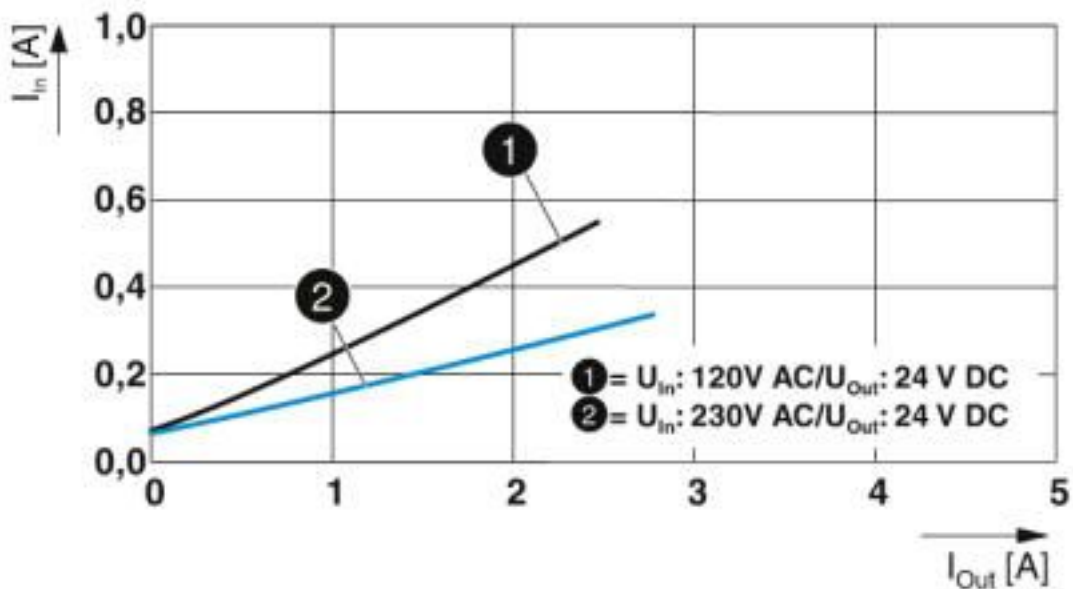

Diagram

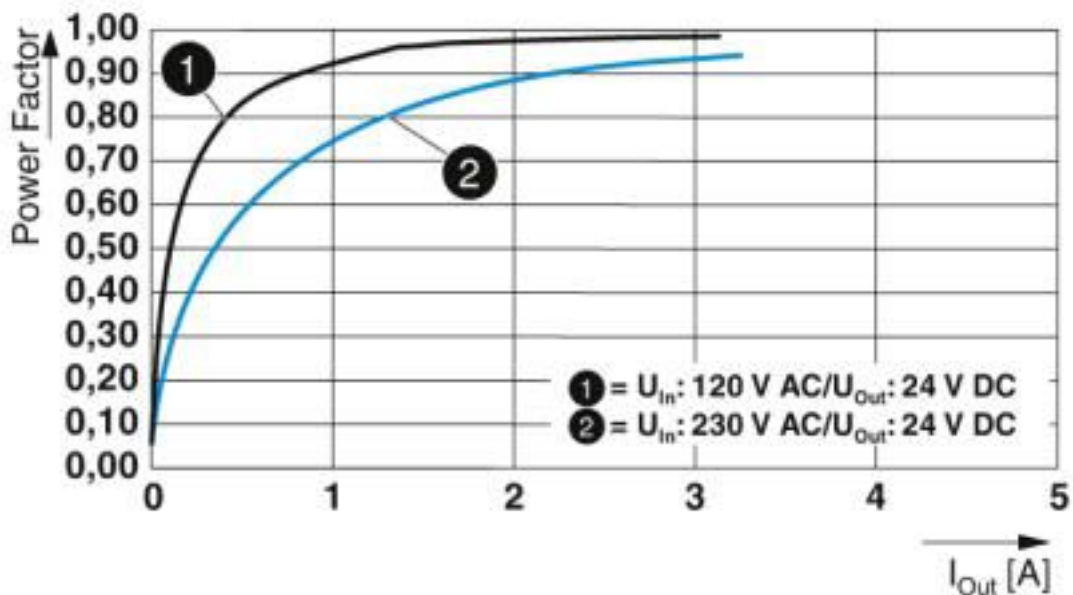

Power supply unit - QUINT4-PS/1AC/24DC/2.5/PT - 2909576

Diagram

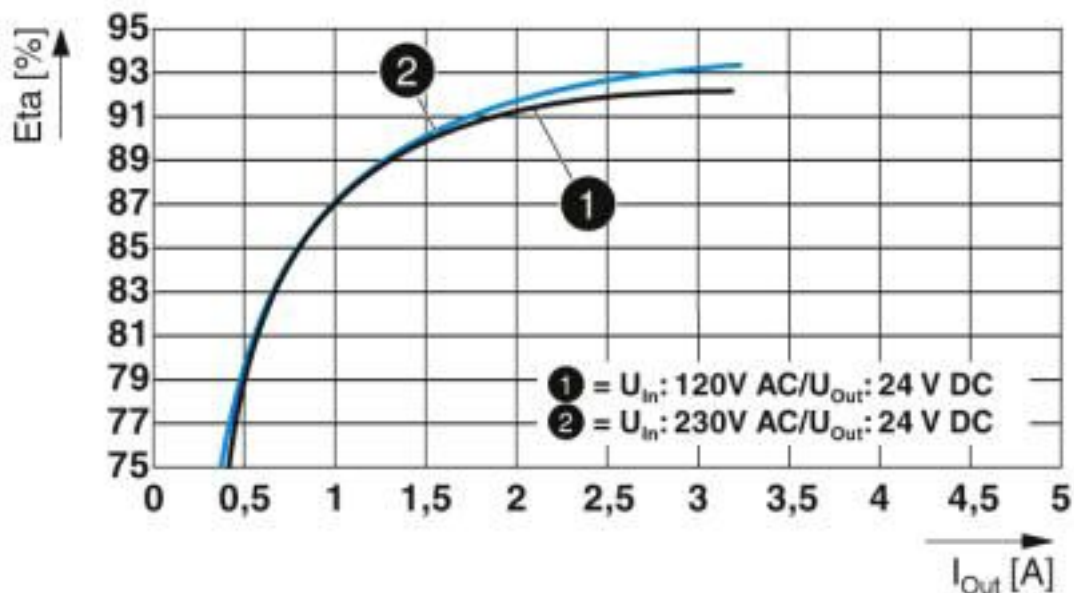

Classifications

eCl@ss

eCl@ss 10.0.1	27040701
eCl@ss 5.1	27242213
eCl@ss 6.0	27049000
eCl@ss 7.0	27049002
eCl@ss 8.0	27049002
eCl@ss 9.0	27040701

ETIM

ETIM 6.0	EC002540
ETIM 7.0	EC002540

UNSPSC

UNSPSC 13.2	39121004
UNSPSC 18.0	39121004
UNSPSC 19.0	39121004
UNSPSC 20.0	39121004
UNSPSC 21.0	39121004

Approvals

Approvals

Power supply unit - QUINT4-PS/1AC/24DC/2.5/PT - 2909576

Approvals

Approvals

UL Listed / IECCE CB Scheme / cUL Listed / EAC / DNV GL / cULus Listed

Ex Approvals

UL Listed / cUL Listed / cULus Listed

Approval details

UL Listed		http://database.ul.com/cgi-bin/XYV/template/LISEXT/1FRAME/index.htm	FILE E 123528
IECEE CB Scheme		http://www.iecee.org/	SI-6218
cUL Listed		http://database.ul.com/cgi-bin/XYV/template/LISEXT/1FRAME/index.htm	FILE E 123528
EAC			RU*DE*08.B.01873/19
DNV GL		https://approvalfinder.dnvgl.com/	TAA00001SN
cULus Listed			

Accessories

Accessories

Device circuit breakers

Power supply unit - QUINT4-PS/1AC/24DC/2.5/PT - 2909576

Accessories

Electronic device circuit breaker - CBMC E4 24DC/1-10A NO - 2906032



Multi-channel electronic device circuit breaker for protecting four loads at 24 V DC in the event of overload and short circuit. With electronic locking of the set nominal currents. For installation on DIN rails.

Electronic device circuit breaker - CBMC E4 24DC/1-4A NO - 2906031



Multi-channel electronic device circuit breaker for protecting four loads at 24 V DC in the event of overload and short circuit. With electronic locking of the set nominal currents. For installation on DIN rails.

Electronic device circuit breaker - CBMC E4 24DC/1-4A NO-C - 2908713



Multi-channel electronic device circuit breaker that can be preconfigured, for protecting four loads at 24 V DC in the event of overload and short circuit. With electronic locking of the set nominal currents. For installation on DIN rails.

Device protection

Type 3 surge protection device - PLT-SEC-T3-230-FM-PT - 2907928



Type 2/3 surge protection, consisting of protective plug and base element with Push-in connection. For single-phase power supply network with integrated status indicator and remote signaling. Nominal voltage 230 V AC/DC.

Type 3 surge protection device - PLT-SEC-T3-24-FM-PT - 2907925



Type 3 surge protection, consisting of protective plug and base element, with integrated status indicator and remote signaling for single-phase power supply networks. Nominal voltage 24 V AC/DC.

Screwdriver tools

Power supply unit - QUINT4-PS/1AC/24DC/2.5/PT - 2909576

Accessories

Screwdriver - SF-SL 0,4X2,0-60 - 1212546



Screwdriver, flat bladed, size: 0.4 x 2.0 x 60 mm, 2-component grip, with non-slip grip

Phoenix Contact 2020 © - all rights reserved
<http://www.phoenixcontact.com>

PHOENIX CONTACT GmbH & Co. KG
Flachsmarktstr. 8
32825 Blomberg
Germany
Tel. +49 5235 300
Fax +49 5235 3 41200
<http://www.phoenixcontact.com>

X-ON Electronics

Largest Supplier of Electrical and Electronic Components

Click to view similar products for [DIN Rail Power Supplies](#) category:

Click to view products by [Phoenix Contact](#) manufacturer:

Other Similar products are found below :

[PS-S6024](#) [DVP01PU-S](#) [DVP06AD-S](#) [DVP06XA-S](#) [DVDPNET-SL](#) [DVPDT01-S](#) [DVPPS01](#) [PS-6012](#) [PS9Z-5R1G](#) [PS-C24024](#)
[DVP08ST11N](#) [DVPACAB530](#) [DVPCOPM-SL](#) [DVPEN01-SL](#) [DVPPF01-S](#) [ADNB008-48-1PM-C](#) [ADNB017-24-1PM-C](#) [ADNB040-24-1PM-C](#) [ADNB034-12-1PM-C](#) [SS14011524](#) [S8TS-06024-E1](#) [PS-UPS40](#) [PSC-6024](#) [PSD-A60W12](#) [96PS-A120WDIN](#) [PSD-A60W48](#) [PSD-A40W12](#) [PSD-A40W24](#) [SMP21-L20-DC24V-5A](#) [PSD-A40W48](#) [S8T-DCBU-02](#) [PS-S4024](#) [NTPS-24-1.3](#) [PST-96024](#) [S82YVSC4P](#) [PS-S4005](#) [PS-10024](#) [PS-S10024](#) [PS-C12024](#) [PSP-480S24](#) [PS-C48024](#) [PSC-2024](#) [PSC-4012](#) [PSC-4048](#) [PSC-9615](#) [PSC-15124](#) [PSC-15148](#)
[PSC-24148](#) [PSC-48148](#) [TRIO-PS-2G/1AC/12DC/5/C2LP](#)