

Electronic device circuit breaker - PTCB E1 24DC/6A NO - 2909908

Please be informed that the data shown in this PDF Document is generated from our Online Catalog. Please find the complete data in the user's documentation. Our General Terms of Use for Downloads are valid (<http://phoenixcontact.com/download>)



Single-channel electronic circuit breaker for protecting 24 V DC loads against overload and short circuit. Simple potential distribution using components from the CLIPLINE complete terminal block system. With fixed nominal current. For installation on DIN rails.

Your advantages

- ✓ Simple application setup due to bridging option to CLIPLINE complete terminal block system
- ✓ More space in the control cabinet: narrowest protection on just 6 mm width
- ✓ Individual setup for suitable protection, exactly according to your requirements

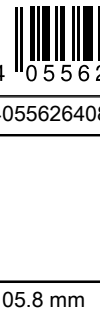

Key Commercial Data

Packing unit	1 pc
GTIN	 4 055626 408750
GTIN	4055626408750

Technical data

Dimensions

Height	105.8 mm
Width	6.2 mm
Depth	55.6 mm (incl. DIN rail 7.5 mm)

Ambient conditions

Ambient temperature (operation)	-30 °C ... 60 °C
Ambient temperature (storage/transport)	-40 °C ... 70 °C
Humidity test	96 h, 95 % RH, 40 °C
Altitude	≤ 3000 m up to 52 °C (amsl (above mean sea level))
	≤ 4000 m up to 46 °C (amsl (above mean sea level))
Shock (operation)	30g (IEC 60068-2-27, Test Ea)
Vibration (operation)	10 Hz ... 59.6 Hz (Amplitude ±0.35 mm; in accordance with IEC 60068-2-6, Test Fc)

Electronic device circuit breaker - PTCB E1 24DC/6A NO - 2909908

Technical data

Ambient conditions

	59.6 Hz ... 150 Hz (Acceleration 5g; in accordance with IEC 60068-2-6, Test Fc)
	5 Hz ... 100 Hz (Resonance search 4g; resonance frequency 4g; 90 min in accordance with DNV GL Class B)
Degree of protection	IP20

General

Flammability rating according to UL 94	V-0
Mounting type	DIN rail: 35 mm
Color	traffic grey A RAL 7042
Number of positions	1
Protection class	III
Degree of pollution	2
Type	DIN rail module, one-piece

Electrical data

Fuse type	electronic
Rated surge voltage	0.5 kV
Operating voltage	18 V DC ... 30 V DC
Rated voltage	24 V DC
Rated current I_N	24 A DC (Total current input)
	6 A DC (Rated current output)
Measuring tolerance I	± 15 %
Feedback resistance	max. 35 V DC
Fail-safe element	15 A DC
Efficiency	> 99 %
Closed circuit current I_0	typ. 12 mA
Power dissipation	typ. 0.3 W (No-load operation)
	< 1.2 W (Nominal operation)
Module initialization time	1 s
Waiting time after switch off of a channel	5 s (at overload / short circuit)
Temperature derating	21 A (Total current at 60°C)
	24 A (Total current at 50°C)
	6 A (Channel current at 60°C)
	6 A (Channel current at 50°C)
Tripping method	E (electronic)
Required backup fuse	Only required if I_{max} of the power supply > the short-circuit switching capacity. Integrated failsafe element.
Short-circuit switching capacity	300 A
Dielectric strength	max. 35 V DC (Load circuit)
Voltage drop	0.1 V (at 6 A)
MTBF (IEC 61709, SN 29500)	25641025 h (at 25°C with 21% load)
	10989010 h (at 40°C with 34.25% load)

Electronic device circuit breaker - PTCB E1 24DC/6A NO - 2909908

Technical data

Electrical data

	1149425 h (at 60°C with 100% load)
Shutdown time load circuit	≤ 10 ms (for short circuit > 2.0 x I _N)
	1 s (1.2 ... 2.0 x I _N)
Undervoltage switch-off load circuit	≤ 17.8 V DC (active)
	≥ 18.8 V DC (inactive)
Overvoltage switch-off shutdown load circuit	≥ 30.5 V DC (active)
	≤ 29.5 V DC (inactive)
Max. capacitive load load circuit	30000 µF (Depending on the available short-circuit current)

Remote indication contact

Connection name	Remote indication circuit
Switching function	N/O contact
Stripping length	10 mm
Conductor cross section solid	0.2 mm ² ... 4 mm ²
Conductor cross section AWG	24 ... 14
Conductor cross section, flexible, with ferrule, with plastic sleeve	0.2 mm ² ... 2.5 mm ²
Conductor cross section flexible, with ferrule without plastic sleeve	0.2 mm ² ... 2.5 mm ²
DC operating voltage	0 V DC ... 30 V DC
DC operating current	100 mA DC

Signaling

Channel LED off	off (Channel switched off)
Channel LED green	lit (Channel switched on)
Channel LED yellow	lit (Channel switched on, channel load > 80%)
	flashing (Programming mode active)
Channel LED red	lit (Channel switched off, over- or undervoltage active)
	ON temporarily (Channel switched off, 5 s cool-down phase, overload or short-circuit release)
	flashing (Channel switched off, ready to be switched back on, overload or short-circuit release)
	flashing quickly (Channel switched off, external voltage at the output, possible installation error)

Connection data

Connection name	Main circuit IN+
Connection method	Push-in connection
Stripping length	10 mm
Conductor cross section solid	0.2 mm ² ... 4 mm ²
Conductor cross section AWG	24 ... 12
Conductor cross section, flexible, with ferrule, with plastic sleeve	0.2 mm ² ... 2.5 mm ²
Conductor cross section flexible, with ferrule without plastic sleeve	0.2 mm ² ... 2.5 mm ²
Connection name	Main circuit IN-
Connection method	Push-in connection

Electronic device circuit breaker - PTCB E1 24DC/6A NO - 2909908

Technical data

Connection data

Stripping length	10 mm
Conductor cross section solid	0.2 mm ² ... 4 mm ²
Conductor cross section AWG	24 ... 12
Conductor cross section, flexible, with ferrule, with plastic sleeve	0.2 mm ² ... 2.5 mm ²
Conductor cross section flexible, with ferrule without plastic sleeve	0.2 mm ² ... 2.5 mm ²
Connection name	Main circuit OUT
Connection method	Push-in connection
Stripping length	10 mm
Conductor cross section solid	0.2 mm ² ... 4 mm ²
Conductor cross section AWG	24 ... 12
Conductor cross section, flexible, with ferrule, with plastic sleeve	0.2 mm ² ... 2.5 mm ²
Conductor cross section flexible, with ferrule without plastic sleeve	0.2 mm ² ... 2.5 mm ²

Standards and Regulations

Standards/specifications	EN 61000-6-2 EMC – Immunity for industrial areas
	EN 61000-6-3 EMC – Emission for residential, business and commercial properties and small operations
	EN 60068-2-78 Environmental influences – Moisture and heat, constant
	EN 50178 Equipping power installations with electronic equipment
	EN 60068-2-6 Environmental influences – Vibrations (sinusoidal)
	EN 60068-2-27 Environmental influences – Shocks
	EN 60068-2-30 Environmental influences – Part 2-30: Tests – Test Db: Damp heat, cyclical

Conformance/approvals

Designation	UL approval
Identification	UL/C-UL Listed UL 508
	UL Recognized UL 2367
Designation	Shipbuilding approval
Identification	DNV GL
Temperature	D
Humidity	B
Vibration	B
EMC	B
Enclosure	A

Environmental Product Compliance

REACH SVHC	Lead 7439-92-1
China RoHS	Environmentally Friendly Use Period = 50 years
	For details about hazardous substances go to tab "Downloads", Category "Manufacturer's declaration"

Drawings

Electronic device circuit breaker - PTCB E1 24DC/6A NO - 2909908

Product drawing



Application drawing

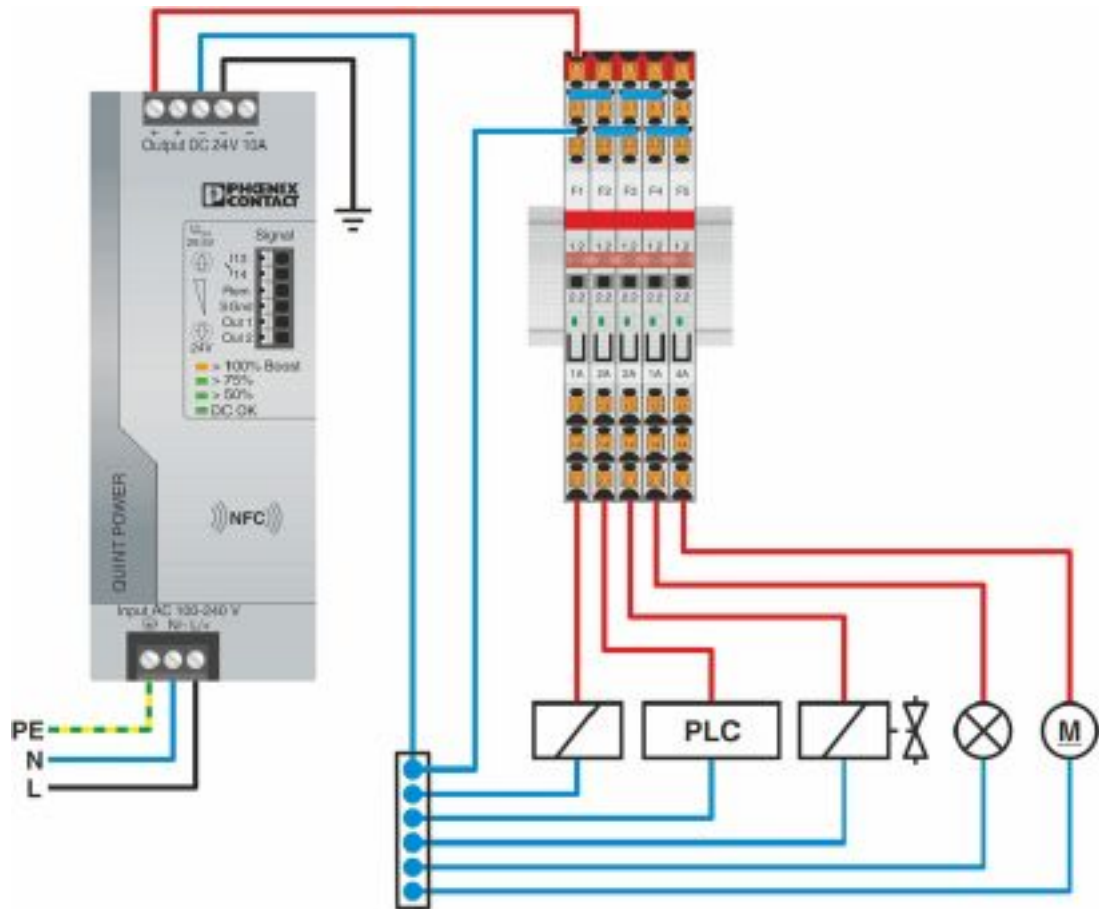

Electronic device circuit breaker - PTCB E1 24DC/6A NO - 2909908

Application drawing

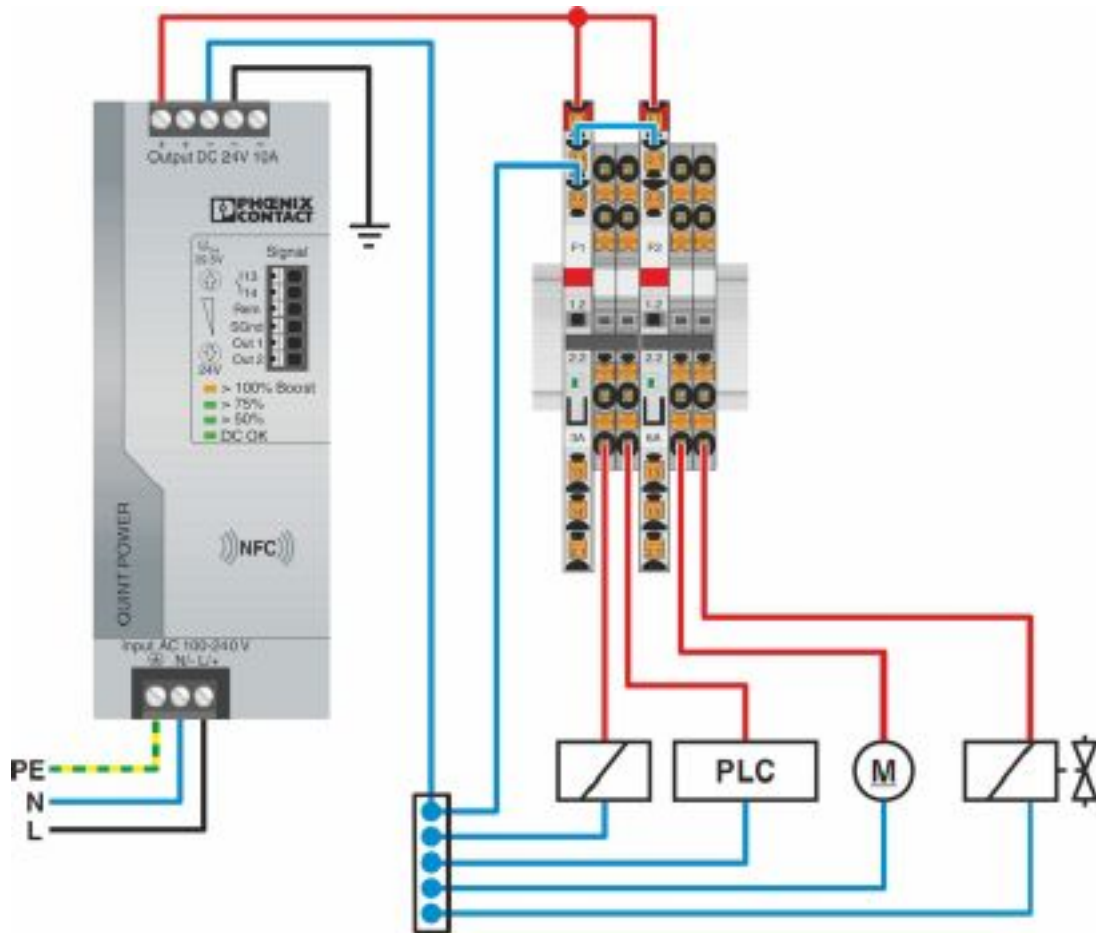

Electronic device circuit breaker - PTCB E1 24DC/6A NO - 2909908

Diagram

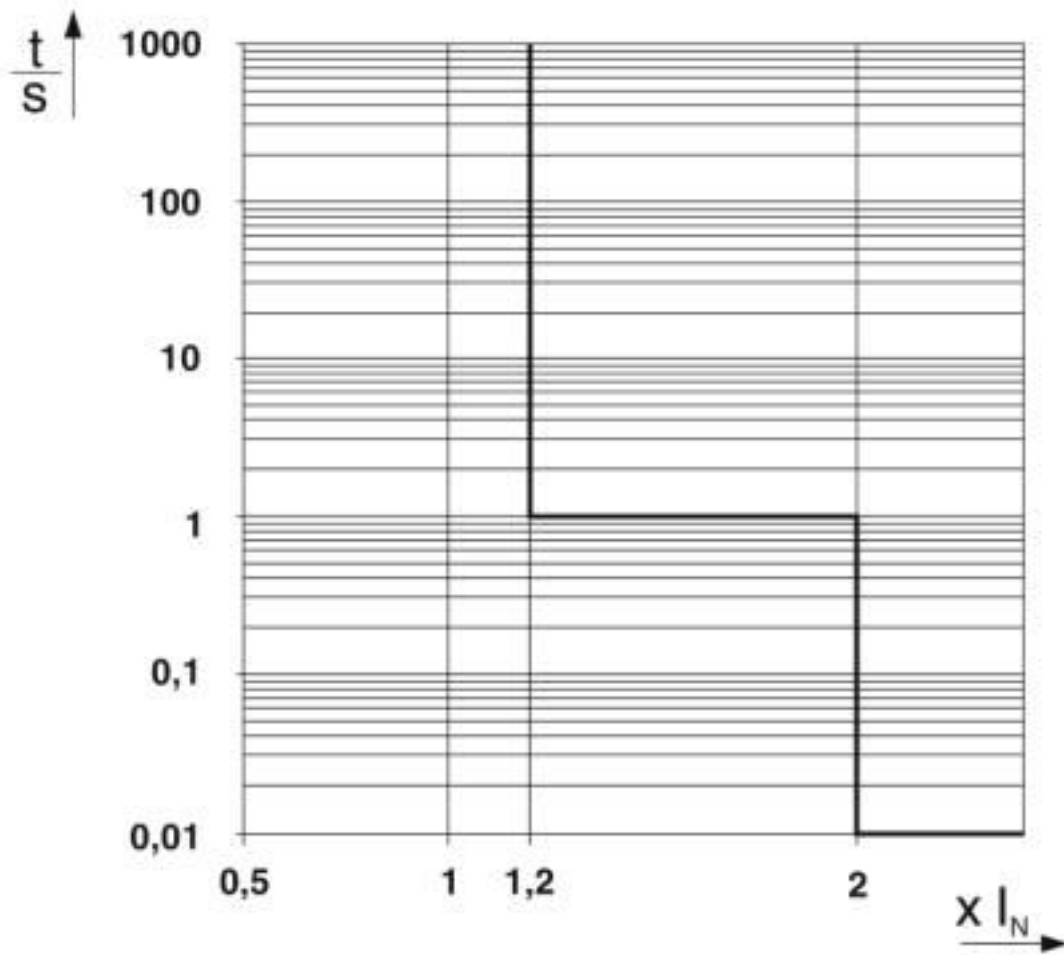

Trigger characteristic in the DC range

Electronic device circuit breaker - PTCB E1 24DC/6A NO - 2909908

Diagram

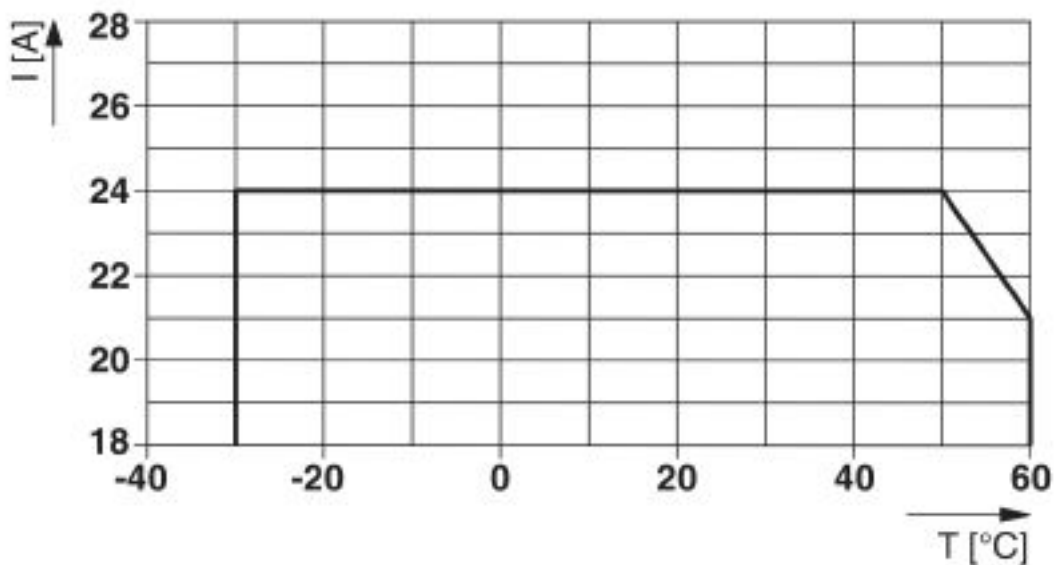

Total current input

Dimensional drawing

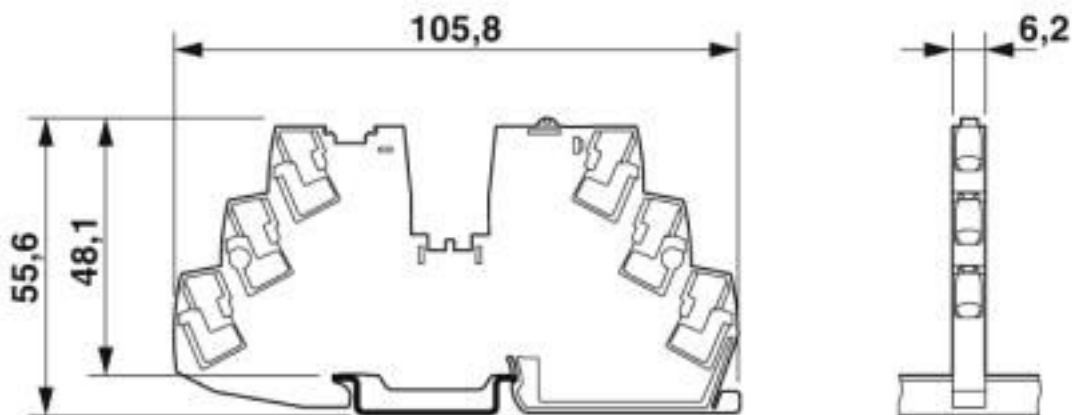

Classifications

eCl@ss

eCl@ss 10.0.1	27140401
eCl@ss 4.0	27141100
eCl@ss 4.1	27141100
eCl@ss 5.0	27141100
eCl@ss 5.1	27141100
eCl@ss 6.0	27141100
eCl@ss 7.0	27141116
eCl@ss 8.0	27141116

Electronic device circuit breaker - PTCB E1 24DC/6A NO - 2909908

Classifications

eCl@ss

eCl@ss 9.0	27141116
------------	----------

ETIM

ETIM 5.0	EC000899
ETIM 6.0	EC000899
ETIM 7.0	EC000899

Approvals

Approvals

Approvals

UL Listed / UL Recognized / cUL Listed / DNV GL / cULus Listed

Ex Approvals

Approval details

UL Listed		http://database.ul.com/cgi-bin/XYV/template/LISEXT/1FRAME/index.htm	FILE E 123528
-----------	--	---	---------------

UL Recognized		http://database.ul.com/cgi-bin/XYV/template/LISEXT/1FRAME/index.htm	FILE E 317172
---------------	--	---	---------------

cUL Listed		http://database.ul.com/cgi-bin/XYV/template/LISEXT/1FRAME/index.htm	FILE E 123528
------------	--	---	---------------

DNV GL		https://approvalfinder.dnvgl.com/	TAE00003UT
--------	--	---	------------

cULus Listed			
--------------	--	--	--

Accessories

Accessories

Electronic device circuit breaker - PTCB E1 24DC/6A NO - 2909908

Accessories

Bridge

Wire bridge - FBSW 2-5/250MM - 3030172



Wire bridge, length: 250 mm, width: 5.1 mm, number of positions: 1, color: red/black

Wire bridge - FBSW 2-5/60MM - 3030170



Wire bridge, length: 60 mm, width: 5.1 mm, number of positions: 1, color: red/black

Wire bridge - FBSW 2-5/110MM - 3030171



Wire bridge, length: 110 mm, width: 5.1 mm, number of positions: 1, color: red/black

Device protection

Type 3 surge protection device - TTC-6P-T3-24DC-PT-I - 1027586



Type 3 surge protection, consisting of protective plug and base element, with integrated status indicator for 24 V DC power supplies.

Feed-through terminal block

Feed-through terminal block - PT 4 - 3211757



Feed-through terminal block, nom. voltage: 800 V, nominal current: 32 A, connection method: Push-in connection, number of connections: 2, cross section: 0.2 mm² - 6 mm², AWG: 24 - 10, width: 6.2 mm, height: 35.3 mm, color: gray, mounting type: NS 35/7,5, NS 35/15

Electronic device circuit breaker - PTCB E1 24DC/6A NO - 2909908

Accessories

Feed-through terminal block - ST 4 - 3031364



Feed-through terminal block, nom. voltage: 800 V, nominal current: 32 A, connection method: Spring-cage connection, number of connections: 2, cross section: 0.08 mm² - 6 mm², AWG: 28 - 10, width: 6.2 mm, color: gray, mounting type: NS 35/7,5, NS 35/15

Feed-through terminal block - QTC 2,5 - 3206416



Feed-through terminal block, nom. voltage: 800 V, nominal current: 24 A, connection method: Quick connection, number of connections: 2, cross section: 0.5 mm² - 2.5 mm², AWG: 20 - 14, width: 6.2 mm, color: gray, mounting type: NS 35/7,5, NS 35/15

Feed-through terminal block - PT 2,5 - 3209510



Feed-through terminal block, nom. voltage: 800 V, nominal current: 24 A, connection method: Push-in connection, number of connections: 2, number of positions: 1, cross section: 0.14 mm² - 4 mm², AWG: 26 - 12, width: 5.2 mm, height: 35.3 mm, color: gray, mounting type: NS 35/7,5, NS 35/15

Feed-through terminal block - ST 2,5 - 3031212



Feed-through terminal block, nom. voltage: 800 V, nominal current: 24 A, connection method: Spring-cage connection, number of connections: 2, cross section: 0.08 mm² - 4 mm², AWG: 28 - 12, width: 5.2 mm, color: gray, mounting type: NS 35/7,5, NS 35/15

Fast connection terminal block - QTC 1,5 - 3205019



Fast connection terminal block, nom. voltage: 800 V, nominal current: 17.5 A, connection method: Quick connection, number of connections: 2, cross section: 0.25 mm² - 1.5 mm², AWG: 24 - 16, width: 5.2 mm, color: gray, mounting type: NS 35/7,5, NS 35/15

Electronic device circuit breaker - PTCB E1 24DC/6A NO - 2909908

Accessories

Feed-through terminal block - PT 10 - 3212120



Feed-through terminal block, nom. voltage: 1000 V, nominal current: 57 A, connection method: Push-in connection, Push-in connection, number of connections: 2, cross section: 0.5 mm² - 16 mm², AWG: 20 - 6, width: 10.2 mm, height: 49.5 mm, color: gray, mounting type: NS 35/7,5, NS 35/15

Feed-through terminal block - ST 10 - 3036110



Feed-through terminal block, nom. voltage: 1000 V, nominal current: 57 A, connection method: Spring-cage connection, number of connections: 2, cross section: 0.2 mm² - 16 mm², AWG: 24 - 6, width: 10.2 mm, color: gray, mounting type: NS 35/7,5, NS 35/15

Jumper

Plug-in bridge - FBS 2-6 - 3030336



Plug-in bridge, pitch: 6.2 mm, width: 10.7 mm, number of positions: 2, color: red

Plug-in bridge - FBS 3-6 - 3030242



Plug-in bridge, pitch: 6.2 mm, width: 16.9 mm, number of positions: 3, color: red

Plug-in bridge - FBS 4-6 - 3030255



Plug-in bridge, pitch: 6.2 mm, width: 23.1 mm, number of positions: 4, color: red

Electronic device circuit breaker - PTCB E1 24DC/6A NO - 2909908

Accessories

Plug-in bridge - FBS 5-6 - 3030349



Plug-in bridge, pitch: 6.2 mm, width: 29.3 mm, number of positions: 5, color: red

Plug-in bridge - FBS 10-6 - 3030271



Plug-in bridge, pitch: 6.2 mm, width: 60.3 mm, number of positions: 10, color: red

Plug-in bridge - FBS 20-6 - 3030365



Plug-in bridge, pitch: 6.2 mm, width: 122.3 mm, number of positions: 20, color: red

Plug-in bridge - FBS 50-6 - 3032224



Plug-in bridge, pitch: 6.2 mm, width: 308.3 mm, number of positions: 50, color: red

Plug-in bridge - FBS 2-6 BU - 3036932



Plug-in bridge, pitch: 6.2 mm, width: 10.7 mm, number of positions: 2, color: blue

Electronic device circuit breaker - PTCB E1 24DC/6A NO - 2909908

Accessories

Plug-in bridge - FBS 3-6 BU - 3036945



Plug-in bridge, pitch: 6.2 mm, width: 16.9 mm, number of positions: 3, color: blue

Plug-in bridge - FBS 4-6 BU - 3036958



Plug-in bridge, pitch: 6.2 mm, width: 23.1 mm, number of positions: 4, color: blue

Plug-in bridge - FBS 5-6 BU - 3036961



Plug-in bridge, pitch: 6.2 mm, width: 29.3 mm, number of positions: 5, color: blue

Plug-in bridge - FBS 10-6 BU - 3032198



Plug-in bridge, pitch: 6.2 mm, width: 60.3 mm, number of positions: 10, color: blue

Plug-in bridge - FBS 20-6 BU - 3032208



Plug-in bridge, pitch: 6.2 mm, width: 122.3 mm, number of positions: 20, color: blue

Electronic device circuit breaker - PTCB E1 24DC/6A NO - 2909908

Accessories

Plug-in bridge - FBS 50-6 BU - 3032211



Plug-in bridge, pitch: 6.2 mm, width: 308.3 mm, number of positions: 50, color: blue

Plug-in bridge - FBS 2-6 GY - 3032237



Plug-in bridge, pitch: 6.2 mm, width: 10.7 mm, number of positions: 2, color: gray

Plug-in bridge - FBS 3-6 GY - 3032240



Plug-in bridge, pitch: 6.2 mm, width: 16.9 mm, number of positions: 3, color: gray

Plug-in bridge - FBS 4-6 GY - 3032279



Plug-in bridge, pitch: 6.2 mm, width: 23.1 mm, number of positions: 4, color: gray

Plug-in bridge - FBS 5-6 GY - 3032266



Plug-in bridge, pitch: 6.2 mm, width: 29.3 mm, number of positions: 5, color: gray

Electronic device circuit breaker - PTCB E1 24DC/6A NO - 2909908

Accessories

Plug-in bridge - FBS 2-5 - 3030161



Plug-in bridge, pitch: 5.2 mm, length: 22.7 mm, width: 9 mm, number of positions: 2, color: red

Plug-in bridge - FBS 3-5 - 3030174



Plug-in bridge, pitch: 5.2 mm, length: 22.7 mm, width: 14.2 mm, number of positions: 3, color: red

Plug-in bridge - FBS 4-5 - 3030187



Plug-in bridge, pitch: 5.2 mm, length: 22.7 mm, width: 19.4 mm, number of positions: 4, color: red

Plug-in bridge - FBS 5-5 - 3030190



Plug-in bridge, pitch: 5.2 mm, length: 23 mm, width: 24.6 mm, number of positions: 5, color: red

Plug-in bridge - FBS 10-5 - 3030213



Plug-in bridge, pitch: 5.2 mm, length: 22.7 mm, width: 50.6 mm, number of positions: 10, color: red

Electronic device circuit breaker - PTCB E1 24DC/6A NO - 2909908

Accessories

Plug-in bridge - FBS 20-5 - 3030226



Plug-in bridge, pitch: 5.2 mm, number of positions: 20, color: red

Plug-in bridge - FBS 50-5 - 3038930



Plug-in bridge, pitch: 5.2 mm, number of positions: 50, color: red

Plug-in bridge - FBS 2-5 BU - 3036877



Plug-in bridge, pitch: 5.2 mm, number of positions: 2, color: blue

Plug-in bridge - FBS 3-5 BU - 3036880



Plug-in bridge, pitch: 5.2 mm, number of positions: 3, color: blue

Plug-in bridge - FBS 4-5 BU - 3036893



Plug-in bridge, pitch: 5.2 mm, number of positions: 4, color: blue

Electronic device circuit breaker - PTCB E1 24DC/6A NO - 2909908

Accessories

Plug-in bridge - FBS 5-5 BU - 3036903



Plug-in bridge, pitch: 5.2 mm, number of positions: 5, color: blue

Plug-in bridge - FBS 10-5 BU - 3036916



Plug-in bridge, pitch: 5.2 mm, number of positions: 10, color: blue

Plug-in bridge - FBS 20-5 BU - 3036929



Plug-in bridge, pitch: 5.2 mm, number of positions: 20, color: blue

Plug-in bridge - FBS 50-5 BU - 3032114



Plug-in bridge, pitch: 5.2 mm, number of positions: 50, color: blue

Plug-in bridge - FBS 2-5 GY - 3038969



Plug-in bridge, pitch: 5.2 mm, number of positions: 2, color: gray

Electronic device circuit breaker - PTCB E1 24DC/6A NO - 2909908

Accessories

Plug-in bridge - FBS 3-5 GY - 3038972



Plug-in bridge, pitch: 5.2 mm, number of positions: 3, color: gray

Plug-in bridge - FBS 4-5 GY - 3038985



Plug-in bridge, pitch: 5.2 mm, number of positions: 4, color: gray

Plug-in bridge - FBS 5-5 GY - 3038998



Plug-in bridge, pitch: 5.2 mm, number of positions: 5, color: gray

Labeled terminal marker

Marker for terminal blocks - UCT-TM 6 CUS - 0829602



Marker for terminal blocks, can be ordered: by sheet, white, labeled according to customer specifications, mounting type: snap into tall marker groove, for terminal block width: 6.2 mm, lettering field size: 5.6 x 10.5 mm, Number of individual labels: 60

Multi-conductor terminal block

Feed-through terminal block - PT 4-TWIN - 3211771



Feed-through terminal block, nom. voltage: 800 V, nominal current: 32 A, connection method: Push-in connection, number of connections: 3, cross section: 0.2 mm² - 6 mm², AWG: 24 - 10, width: 6.2 mm, color: gray, mounting type: NS 35/7,5, NS 35/15

Electronic device circuit breaker - PTCB E1 24DC/6A NO - 2909908

Accessories

Feed-through terminal block - PT 4-QUATTRO - 3211797



Feed-through terminal block, nom. voltage: 800 V, nominal current: 32 A, connection method: Push-in connection, number of connections: 4, cross section: 0.2 mm² - 6 mm², AWG: 24 - 10, width: 6.2 mm, height: 35.3 mm, color: gray, mounting type: NS 35/7,5, NS 35/15

Feed-through terminal block - ST 4-TWIN - 3031393



Feed-through terminal block, nom. voltage: 800 V, nominal current: 32 A, connection method: Spring-cage connection, number of connections: 3, cross section: 0.08 mm² - 6 mm², AWG: 28 - 10, width: 6.2 mm, color: gray, mounting type: NS 35/7,5, NS 35/15

Feed-through terminal block - ST 4-QUATTRO - 3031445



Feed-through terminal block, nom. voltage: 800 V, nominal current: 32 A, connection method: Spring-cage connection, number of connections: 4, cross section: 0.08 mm² - 6 mm², AWG: 28 - 10, width: 6.2 mm, color: gray, mounting type: NS 35/7,5, NS 35/15

Feed-through terminal block - QTC 2,5-TWIN - 3206445



Feed-through terminal block, nom. voltage: 800 V, nominal current: 24 A, connection method: Quick connection, number of connections: 3, cross section: 0.5 mm² - 2.5 mm², AWG: 20 - 14, width: 6.2 mm, height: 37.8 mm, color: gray, mounting type: NS 35/7,5, NS 35/7,5

Feed-through terminal block - QTC 2,5-QUATTRO - 3206446



Feed-through terminal block, nom. voltage: 800 V, nominal current: 24 A, connection method: Quick connection, number of connections: 4, cross section: 0.5 mm² - 2.5 mm², AWG: 20 - 14, width: 6.2 mm, height: 37.8 mm, color: gray, mounting type: NS 35/7,5, NS 35/7,5

Electronic device circuit breaker - PTCB E1 24DC/6A NO - 2909908

Accessories

Feed-through terminal block - PT 2,5-TWIN - 3209549



Feed-through terminal block, nom. voltage: 800 V, nominal current: 24 A, connection method: Push-in connection, number of connections: 3, cross section: 0.14 mm² - 4 mm², AWG: 26 - 12, width: 5.2 mm, height: 35.2 mm, color: gray, mounting type: NS 35/7,5, NS 35/15

Feed-through terminal block - PT 2,5-QUATTRO - 3209578



Feed-through terminal block, nom. voltage: 800 V, nominal current: 24 A, connection method: Push-in connection, number of connections: 4, cross section: 0.14 mm² - 4 mm², AWG: 26 - 12, width: 5.2 mm, height: 35.3 mm, color: gray, mounting type: NS 35/7,5, NS 35/15

Feed-through terminal block - ST 2,5-TWIN - 3031241



Feed-through terminal block, nom. voltage: 800 V, nominal current: 24 A, connection method: Spring-cage connection, number of connections: 3, cross section: 0.08 mm² - 4 mm², AWG: 28 - 12, width: 5.2 mm, color: gray, mounting type: NS 35/7,5, NS 35/15

Feed-through terminal block - ST 2,5-QUATTRO - 3031306



Feed-through terminal block, nom. voltage: 800 V, nominal current: 24 A, connection method: Spring-cage connection, number of connections: 4, cross section: 0.08 mm² - 4 mm², AWG: 28 - 12, width: 5.2 mm, color: gray, mounting type: NS 35/7,5, NS 35/15

Feed-through terminal block - QTC 1,5-TWIN - 3205048



Feed-through terminal block, nom. voltage: 800 V, nominal current: 17.5 A, connection method: Quick connection, number of connections: 3, cross section: 0.25 mm² - 1.5 mm², AWG: 24 - 16, width: 5.2 mm, color: gray, mounting type: NS 35/7,5, NS 35/7,5

Electronic device circuit breaker - PTCB E1 24DC/6A NO - 2909908

Accessories

Feed-through terminal block - QTC 1,5-QUATTRO - 3205077



Feed-through terminal block, nom. voltage: 800 V, nominal current: 17.5 A, connection method: Quick connection, number of connections: 4, cross section: 0.25 mm² - 1.5 mm², AWG: 24 - 16, width: 5.2 mm, color: gray, mounting type: NS 35/7,5, NS 35/7,5

Reducing bridge

Reducing bridge - RB ST 10-(2,5/4) - 3030873



Reducing bridge, pitch: 10 mm, length: 36.3 mm, width: 15 mm, number of positions: 2, color: red

Terminal marking

Zack marker strip - ZB 6:UNBEDRUCKT - 1051003



Zack marker strip, Strip, white, unlabeled, can be labeled with: PLOTMARK, CMS-P1-PLOTTER, mounting type: snap into tall marker groove, for terminal block width: 6.2 mm, lettering field size: 6.15 x 10.5 mm, Number of individual labels: 10

Zack Marker strip, flat - ZBF 6:UNBEDRUCKT - 0808710



Zack Marker strip, flat, Strip, white, unlabeled, can be labeled with: PLOTMARK, CMS-P1-PLOTTER, mounting type: snap into flat marker groove, for terminal block width: 6.2 mm, lettering field size: 5.15 x 6.15 mm, Number of individual labels: 10

Marker for terminal blocks - UCT-TM 6 - 0828736



Marker for terminal blocks, Sheet, white, unlabeled, can be labeled with: TOPMARK NEO, TOPMARK LASER, BLUEMARK ID COLOR, BLUEMARK ID, BLUEMARK CLED, THERMOMARK PRIME, THERMOMARK CARD 2.0, THERMOMARK CARD, mounting type: snap into tall marker groove, for terminal block width: 6.2 mm, lettering field size: 5.6 x 10.5 mm, Number of individual labels: 60

Electronic device circuit breaker - PTCB E1 24DC/6A NO - 2909908

Accessories

Marker for terminal blocks - US-TML (104X3,8) - 0830768

Marker for terminal blocks, Card, white, unlabeled, can be labeled with: BLUEMARK ID COLOR, BLUEMARK ID, THERMOMARK PRIME, THERMOMARK CARD 2.0, THERMOMARK CARD, mounting type: adhesive, lettering field size: 104 x 3.8 mm, Number of individual labels: 22



Phoenix Contact 2020 © - all rights reserved
<http://www.phoenixcontact.com>

PHOENIX CONTACT GmbH & Co. KG
Flachsmarktstr. 8
32825 Blomberg
Germany
Tel. +49 5235 300
Fax +49 5235 3 41200
<http://www.phoenixcontact.com>

X-ON Electronics

Largest Supplier of Electrical and Electronic Components

Click to view similar products for [Circuit Breaker Accessories](#) category:

Click to view products by [Phoenix Contact](#) manufacturer:

Other Similar products are found below :

[CSC-403PS](#) [8T1-D-11A](#) [8T1-E-125](#) [B151-7184-L](#) [NEB10](#) [8C1-C-721](#) [8T1-E-115](#) [8T1-E-275](#) [8T1-E-278](#) [506-11315-001](#) [3803221](#)
[X10506BF](#) [NES](#) [9-1393249-0](#) [802-ESB50UL489](#) [XFPB-4](#) [30.329](#) [X22261102](#) [CX2.5/4/O](#) [Y30019003](#) [PS-1006](#) [618.6335.069](#) [BAC03](#)
[JX2.5/4](#) [JX2.5/6](#) [JX2.5/5](#) [HSP6/10U](#) [DMRBU](#) [BLACK BOX](#) [DB16/BU](#) [CM2.5S2](#) [932146100](#) [930120000](#) [601.1231.909](#) [3PRG1](#)
[3PLBR4LU](#) [351.5900.149](#) [311.2850.340](#) [2624.0](#) [17BSSV](#) [1-1423696-8](#) [LS3-WH](#) [BAC12](#) [30.617](#) [8T1-E-114](#) [SF06-5,08](#) [2LP199](#) [ZG20-2](#)
[3PSML401](#) [3PSML402](#) [2LP219](#)