

# Relay Module - PLC-RSC- 24DC/21-21/MS - 2910502

Please be informed that the data shown in this PDF Document is generated from our Online Catalog. Please find the complete data in the user's documentation. Our General Terms of Use for Downloads are valid (<http://phoenixcontact.com/download>)



PLC-INTERFACE, consisting of a relay base and pluggable power contact relay with manual operation, integrated status LED and freewheeling diode, Screw connection, 2 PDT, Input voltage: 24 V DC



## Key Commercial Data

Packing unit	10 pc
GTIN	
GTIN	4055626486079

## Technical data

### Note

Utilization restriction	EMC: class A product, see manufacturer's declaration in the download area
-------------------------	---

### Dimensions

Width	14 mm
Height	80 mm
Depth	104 mm

### Ambient conditions

Ambient temperature (operation)	-20 °C ... 60 °C
Ambient temperature (storage/transport)	-20 °C ... 85 °C
Maximum altitude	≤ 2000 m
Degree of protection	RT II (Relay)
	IP20 (Relay base)
	≥ IP54 (Installation location)

### Coil side

Nominal input voltage $U_N$	24 V DC
Typical input current at $U_N$	18 mA

# Relay Module - PLC-RSC- 24DC/21-21/MS - 2910502

## Technical data

### Coil side

Typical response time	10 ms
Typical release time	10 ms
Coil voltage	24 V DC
Protective circuit	Free-wheeling diode Damping diode
Operating voltage display	Yellow LED

### Contact side

Contact type	2 PDT
Type of switch contact	Single contact
Contact material	AgNi
Maximum switching voltage	250 V AC/DC (The separating plate PLC-ATP should be installed for voltages larger than 250 V (L1, L2, L3) between identical terminal blocks in adjacent modules. Potential bridging is then carried out with FBST 8-PLC... or ...FBST 500...)
Minimum switching voltage	12 V (10 mA)
Min. switching current	10 mA (12 V)
Maximum inrush current	12 A (20 ms)
Limiting continuous current	6 A
Interrupting rating (ohmic load) max.	192 W (24 V DC)
	62 W (48 V DC)
	42 W (60 V DC)
	55 W (110 V DC)
	66 W (220 V DC)
	2000 VA (250 V AC)
Switching capacity	1 A (24 V, DC13)
	1.5 A (230 V, AC15)

### General

Test voltage relay winding/relay contact	4 kV AC (50 Hz, 1 min.)
Test voltage PDT/PDT	2.5 kV AC (50 Hz, 1 min.)
Operating mode	100% operating factor
Flammability rating according to UL 94	V0 (Housing)
Mechanical service life	5x 10 <sup>6</sup> cycles
Mounting position	any
Assembly instructions	In rows with zero spacing

### Connection data

Connection name	Coil side
Connection method	Screw connection
Stripping length	8 mm
Screw thread	M3
Conductor cross section solid	0.14 mm <sup>2</sup> ... 2.5 mm <sup>2</sup>
Conductor cross section flexible	0.14 mm <sup>2</sup> ... 2.5 mm <sup>2</sup>

# Relay Module - PLC-RSC- 24DC/21-21/MS - 2910502

## Technical data

### Connection data

	0.2 mm <sup>2</sup> ... 2.5 mm <sup>2</sup> (Single ferrule)
	2x 0.5 mm <sup>2</sup> ... 1.5 mm <sup>2</sup> (TWIN ferrule)
Conductor cross section AWG	26 ... 14

### Connection data 2

Connection name	Contact side
Connection method	Screw connection
Stripping length	8 mm
Screw thread	M3
Conductor cross section solid	0.14 mm <sup>2</sup> ... 2.5 mm <sup>2</sup>
Conductor cross section flexible	0.14 mm <sup>2</sup> ... 2.5 mm <sup>2</sup>
	0.2 mm <sup>2</sup> ... 2.5 mm <sup>2</sup> (Single ferrule)
	2x 0.5 mm <sup>2</sup> ... 1.5 mm <sup>2</sup> (TWIN ferrule)
Conductor cross section AWG	26 ... 14

### Standards and Regulations

Designation	Standards/regulations
Standards/regulations	EN 50178
Rated surge voltage	6 kV
Insulation	Safe isolation: Control side / contact side
Pollution degree	2
Overvoltage category	III
UL, USA	UL 508
	UL 508 Recognized
UL, USA/Canada	cUL 508
	cUL 508 Recognized

### Conformance/approvals

Designation	UL, USA
Identification	UL 508
	UL 508 Recognized
Designation	UL, USA/Canada
Identification	UL 508
	UL 508 Recognized

### Environmental Product Compliance

REACH SVHC	Lead 7439-92-1
China RoHS	Environmentally Friendly Use Period = 50 years
	For details about hazardous substances go to tab "Downloads", Category "Manufacturer's declaration"

## Drawings

## Relay Module - PLC-RSC- 24DC/21-21/MS - 2910502

Diagram

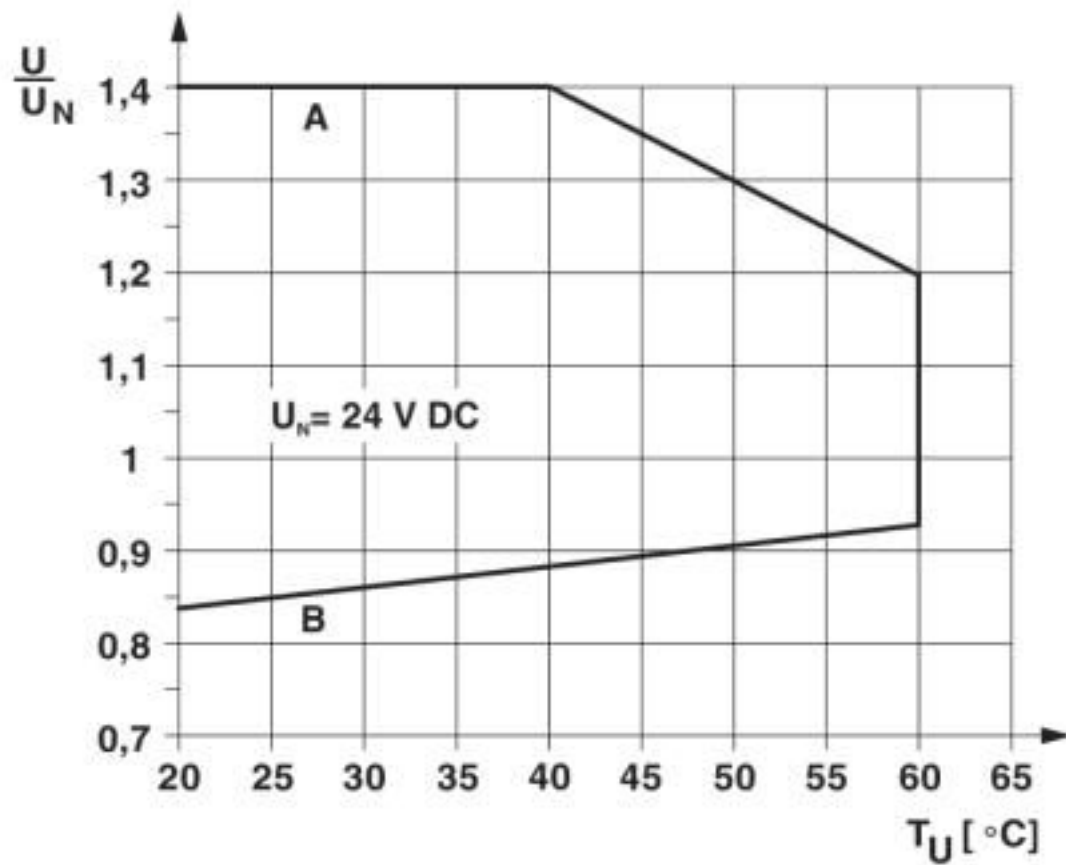

Curve A

Maximum permissible continuous voltage  $U_{\max}$  with limiting continuous current on the contact side (see relevant technical data)

Curve B

Minimum permissible operate voltage  $U_{\text{op}}$  after pre-excitation (see relevant technical data)

# Relay Module - PLC-RSC- 24DC/21-21/MS - 2910502

Diagram

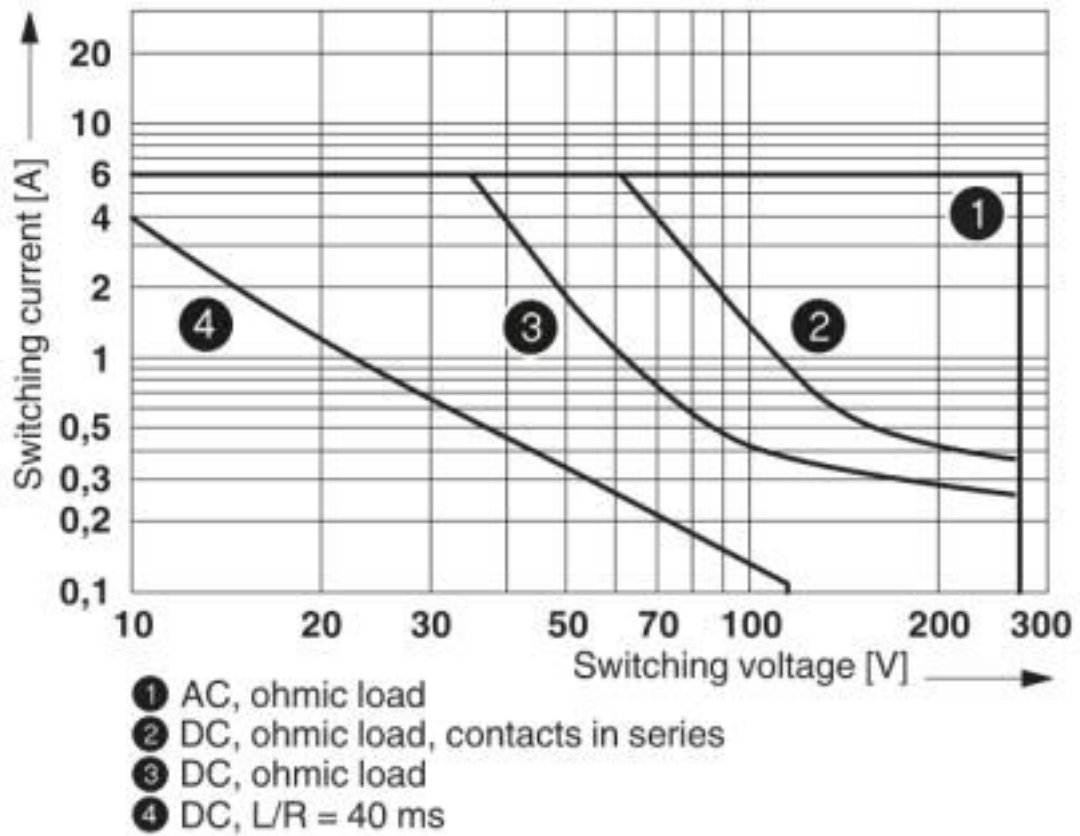

Interrupting rating

# Relay Module - PLC-RSC- 24DC/21-21/MS - 2910502

Diagram

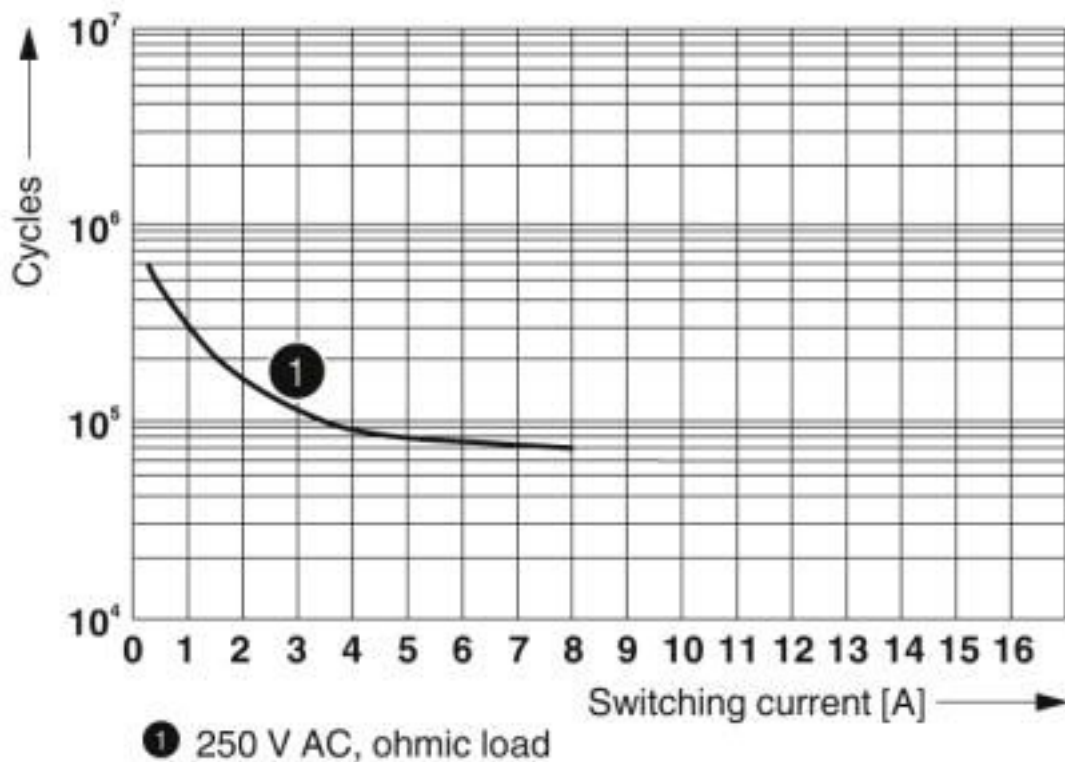

Electrical service life

Diagram

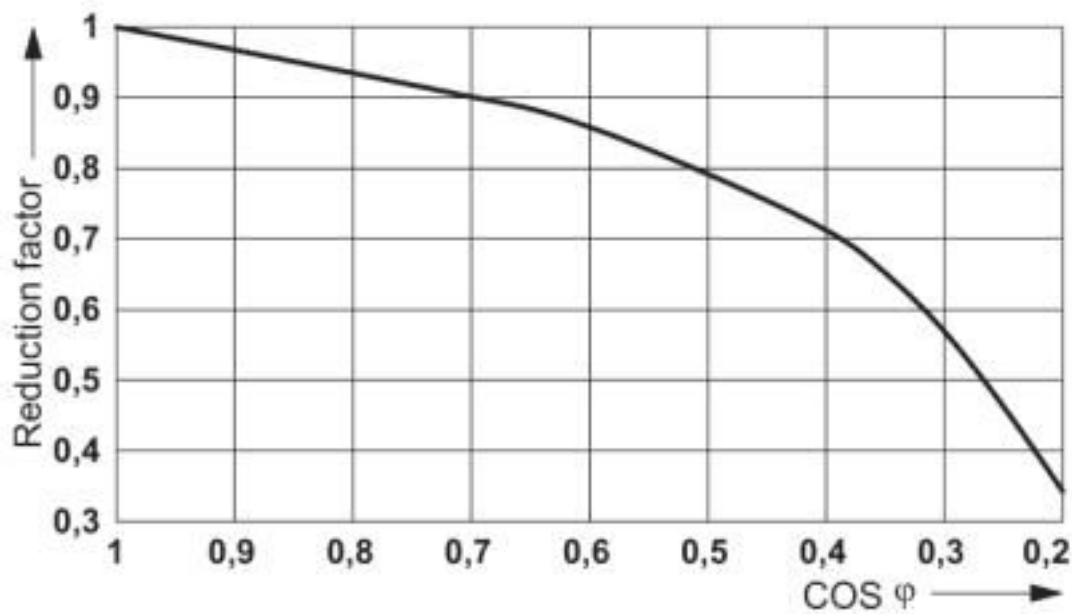

Service life reduction factor

## Relay Module - PLC-RSC- 24DC/21-21/MS - 2910502

Circuit diagram

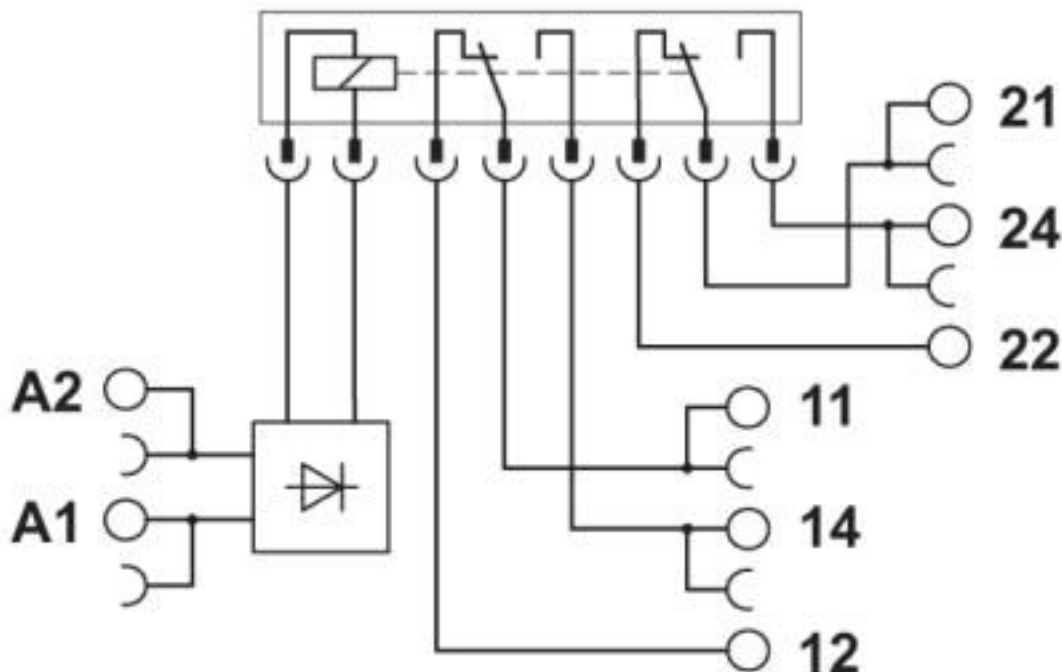

### Articles in set

Relay base - PLC-BSC- 24DC/21-21/H - 1011983



14 mm PLC basic terminal block without relay, for mounting on DIN rail NS 35/7,5, Screw connection, 2 PDT, Input voltage 24 V DC

Single relay - REL-MR- 24DC/21-21/MS - 2987943



Plug-in miniature relay, with power contact, 2 PDTs, test button, mechanical switch position indicator, status LED, freewheeling diode, polarity A1+, A2, input voltage 24 V DC

### Classifications

eCl@ss

eCl@ss 10.0.1	27371601
eCl@ss 5.0	27371600
eCl@ss 5.1	27371600
eCl@ss 6.0	27371600

# Relay Module - PLC-RSC- 24DC/21-21/MS - 2910502

## Classifications

### eCl@ss

eCl@ss 7.0	27371601
eCl@ss 8.0	27371601
eCl@ss 9.0	27371601

### ETIM

ETIM 2.0	EC001437
ETIM 3.0	EC001437
ETIM 4.0	EC001437
ETIM 5.0	EC001437
ETIM 6.0	EC001437
ETIM 7.0	EC001437

### UNSPSC

UNSPSC 6.01	30211916
UNSPSC 7.0901	39121515
UNSPSC 11	39121515
UNSPSC 12.01	39121515
UNSPSC 13.2	39122334
UNSPSC 18.0	39122334
UNSPSC 19.0	39122334
UNSPSC 20.0	39122334
UNSPSC 21.0	39122334

## Approvals

### Approvals

---

#### Approvals

UL Listed / UL Recognized / cUL Recognized / cUL Listed / DNV GL / EAC / EAC / cULus Recognized / cULus Listed

---

#### Ex Approvals

---

### Approval details

UL Listed		<a href="http://database.ul.com/cgi-bin/XYV/template/LISEXT/1FRAME/index.htm">http://database.ul.com/cgi-bin/XYV/template/LISEXT/1FRAME/index.htm</a>	FILE E 172140
-----------	---	---	---------------



# Relay Module - PLC-RSC- 24DC/21-21/MS - 2910502

## Approvals

UL Recognized		<a href="http://database.ul.com/cgi-bin/XYV/template/LISEXT/1FRAME/index.htm">http://database.ul.com/cgi-bin/XYV/template/LISEXT/1FRAME/index.htm</a>	FILE E 238705
---------------	--	---	---------------

cUL Recognized		<a href="http://database.ul.com/cgi-bin/XYV/template/LISEXT/1FRAME/index.htm">http://database.ul.com/cgi-bin/XYV/template/LISEXT/1FRAME/index.htm</a>	FILE E 238705
----------------	--	---	---------------

cUL Listed		<a href="http://database.ul.com/cgi-bin/XYV/template/LISEXT/1FRAME/index.htm">http://database.ul.com/cgi-bin/XYV/template/LISEXT/1FRAME/index.htm</a>	FILE E 172140
------------	--	---	---------------

DNV GL		<a href="https://approvalfinder.dnvgl.com/">https://approvalfinder.dnvgl.com/</a>	TAE0000196-03
--------	--	---	---------------

EAC			TR_TS_D_00573_c
-----	--	--	-----------------

EAC			RU*C- DE.*08.B.00010
-----	--	--	-------------------------

cULus Recognized			
------------------	--	--	--

cULus Listed			
--------------	--	--	--

## Accessories

### Accessories

#### Bridge

Continuous plug-in bridge - FBST 500-PLC RD - 2966786



Continuous plug-in bridge, length: 500 mm, color: red

## Relay Module - PLC-RSC- 24DC/21-21/MS - 2910502

### Accessories

---

Continuous plug-in bridge - FBST 500-PLC BU - 2966692



Continuous plug-in bridge, length: 500 mm, color: blue

---

Continuous plug-in bridge - FBST 500-PLC GY - 2966838



Continuous plug-in bridge, length: 500 mm, color: gray

---

Single plug-in bridge - FBST 6-PLC RD - 2966236



Single plug-in bridge, length: 6 mm, number of positions: 2, color: red

---

Single plug-in bridge - FBST 6-PLC BU - 2966812



Single plug-in bridge, length: 6 mm, number of positions: 2, color: blue

---

Single plug-in bridge - FBST 6-PLC GY - 2966825



Single plug-in bridge, length: 6 mm, number of positions: 2, color: gray

---

## Relay Module - PLC-RSC- 24DC/21-21/MS - 2910502

### Accessories

Single plug-in bridge - FBST 6-PLC RD - 2966236



Single plug-in bridge, length: 6 mm, number of positions: 2, color: red

---

Single plug-in bridge - FBST 6-PLC RD - 2966236



Single plug-in bridge, length: 6 mm, number of positions: 2, color: red

---

### Controller board

System connection - PLC-V8L/FLK14/OUT - 2299660



V8 adapter for 8 x PLC-INTERFACE (14 mm), controller: PLC system cabling of output cards, connection 1: Screw connection 1x, connection 2: IDC/FLK pin strip 1x 14-position, connection 3: Plug connection (Can be snapped onto 8x PLC-INTERFACE terminals), number of channels: 8, control logic: positive switching

---

System connection - PLC-V8L/FLK14/OUT/M - 2304306



V8 adapter for 8 x PLC-INTERFACE (14 mm), controller: PLC system cabling of output cards, connection 1: Screw connection 1x, connection 2: IDC/FLK pin strip 1x 14-position, connection 3: Plug connection (Can be snapped onto 8x PLC-INTERFACE terminals), number of channels: 8, control logic: negative switching

---

### DIN rail

DIN rail perforated - NS 35/ 7,5 PERF 2000MM - 0801733



DIN rail perforated, Standard profile, width: 35 mm, height: 7.5 mm, acc. to EN 60715, material: Steel, galvanized, passivated with a thick layer, length: 2000 mm, color: silver

---

## Relay Module - PLC-RSC- 24DC/21-21/MS - 2910502

### Accessories

DIN rail, unperforated - NS 35/ 7,5 UNPERF 2000MM - 0801681



DIN rail, unperforated, Standard profile, width: 35 mm, height: 7.5 mm, acc. to EN 60715, material: Steel, galvanized, passivated with a thick layer, length: 2000 mm, color: silver

---

DIN rail perforated - NS 35/ 7,5 WH PERF 2000MM - 1204119



DIN rail perforated, Standard profile, width: 35 mm, height: 7.5 mm, acc. to EN 60715, material: Steel, Galvanized, white passivated, length: 2000 mm, color: silver

---

DIN rail, unperforated - NS 35/ 7,5 WH UNPERF 2000MM - 1204122



DIN rail, unperforated, Standard profile, width: 35 mm, height: 7.5 mm, acc. to EN 60715, material: Steel, Galvanized, white passivated, length: 2000 mm, color: silver

---

DIN rail, unperforated - NS 35/ 7,5 AL UNPERF 2000MM - 0801704



DIN rail, unperforated, Standard profile, width: 35 mm, height: 7.5 mm, acc. to EN 60715, material: Aluminum, uncoated, length: 2000 mm, color: silver

---

DIN rail perforated - NS 35/ 7,5 ZN PERF 2000MM - 1206421



DIN rail perforated, Standard profile, width: 35 mm, height: 7.5 mm, acc. to EN 60715, material: Steel, galvanized, length: 2000 mm, color: silver

---

## Relay Module - PLC-RSC- 24DC/21-21/MS - 2910502

### Accessories

DIN rail, unperforated - NS 35/ 7,5 ZN UNPERF 2000MM - 1206434



DIN rail, unperforated, Standard profile, width: 35 mm, height: 7.5 mm, acc. to EN 60715, material: Steel, galvanized, length: 2000 mm, color: silver

---

DIN rail, unperforated - NS 35/ 7,5 CU UNPERF 2000MM - 0801762



DIN rail, unperforated, Standard profile, width: 35 mm, height: 7.5 mm, acc. to EN 60715, material: Copper, uncoated, length: 2000 mm, color: copper-colored

---

End cap - NS 35/ 7,5 CAP - 1206560



DIN rail end piece, for DIN rail NS 35/7.5

---

DIN rail perforated - NS 35/15 PERF 2000MM - 1201730



DIN rail perforated, Standard profile, width: 35 mm, height: 15 mm, similar to EN 60715, material: Steel, galvanized, passivated with a thick layer, length: 2000 mm, color: silver

---

DIN rail, unperforated - NS 35/15 UNPERF 2000MM - 1201714

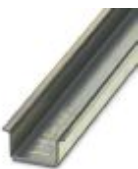

DIN rail, unperforated, Standard profile, width: 35 mm, height: 15 mm, similar to EN 60715, material: Steel, galvanized, passivated with a thick layer, length: 2000 mm, color: silver

---

## Relay Module - PLC-RSC- 24DC/21-21/MS - 2910502

### Accessories

DIN rail perforated - NS 35/15 WH PERF 2000MM - 0806602



DIN rail perforated, Standard profile, width: 35 mm, height: 15 mm, similar to EN 60715, material: Steel, Galvanized, white passivated, length: 2000 mm, color: silver

---

DIN rail, unperforated - NS 35/15 WH UNPERF 2000MM - 1204135



DIN rail, unperforated, Standard profile, width: 35 mm, height: 15 mm, similar to EN 60715, material: Steel, Galvanized, white passivated, length: 2000 mm, color: silver

---

DIN rail, unperforated - NS 35/15 AL UNPERF 2000MM - 1201756



DIN rail, unperforated, Standard profile, width: 35 mm, height: 15 mm, similar to EN 60715, material: Aluminum, uncoated, length: 2000 mm, color: silver

---

DIN rail perforated - NS 35/15 ZN PERF 2000MM - 1206599



DIN rail perforated, Standard profile, width: 35 mm, height: 15 mm, similar to EN 60715, material: Steel, galvanized, length: 2000 mm, color: silver

---

DIN rail, unperforated - NS 35/15 ZN UNPERF 2000MM - 1206586



DIN rail, unperforated, Standard profile, width: 35 mm, height: 15 mm, similar to EN 60715, material: Steel, galvanized, length: 2000 mm, color: silver

---

## Relay Module - PLC-RSC- 24DC/21-21/MS - 2910502

### Accessories

DIN rail, unperforated - NS 35/15 CU UNPERF 2000MM - 1201895



DIN rail, unperforated, Standard profile, width: 35 mm, height: 15 mm, similar to EN 60715, material: Copper, uncoated, length: 2000 mm, color: copper-colored

---

End cap - NS 35/15 CAP - 1206573



DIN rail end piece, for DIN rail NS 35/15

---

DIN rail, unperforated - NS 35/15-2,3 UNPERF 2000MM - 1201798



DIN rail, unperforated, Standard profile 2.3 mm, width: 35 mm, height: 15 mm, acc. to EN 60715, material: Steel, galvanized, passivated with a thick layer, length: 2000 mm, color: silver

---

### Labeled terminal marker

Zack marker strip - ZB 10 CUS - 0824941



Zack marker strip, can be ordered: Strip, white, labeled according to customer specifications, mounting type: snap into tall marker groove, for terminal block width: 10.2 mm, lettering field size: 10.15 x 10.5 mm, Number of individual labels: 10

---

Zack marker strip - ZB10,LGS:FORTL.ZAHLEN - 1053014



Zack marker strip, Strip, white, labeled, can be labeled with: CMS-P1-PLOTTER, printed horizontally: consecutive numbers 1 ... 10, 11 ... 20, etc. up to 91 ... 100, mounting type: snap into tall marker groove, for terminal block width: 10.2 mm, lettering field size: 10.15 x 10.5 mm, Number of individual labels: 10

---

## Relay Module - PLC-RSC- 24DC/21-21/MS - 2910502

### Accessories

#### Zack marker strip - ZB10,QR:FORTL.ZAHLEN - 1053027



Zack marker strip, Strip, white, labeled, can be labeled with: CMS-P1-PLOTTER, Printed vertically: consecutive numbers 1 ... 10, 11 ... 20, etc. up to 91 ... 100, mounting type: snap into tall marker groove, for terminal block width: 10.2 mm, lettering field size: 10.15 x 10.5 mm, Number of individual labels: 10

---

#### Marker for terminal blocks - ZB10,LGS:L1-N,PE - 1053412



Marker for terminal blocks, Strip, white, labeled, can be labeled with: CMS-P1-PLOTTER, horizontal: L1, L2, L3, N, PE, L1, L2, L3, N, PE, mounting type: snap into tall marker groove, for terminal block width: 10.2 mm, lettering field size: 10.15 x 10.5 mm, Number of individual labels: 10

---

#### Marker for terminal blocks - ZB10,LGS:U-N - 1053438



Marker for terminal blocks, Strip, white, labeled, can be labeled with: CMS-P1-PLOTTER, horizontal: U, V, W, N, GND, U, V, W, N, GND, mounting type: snap into tall marker groove, for terminal block width: 10.2 mm, lettering field size: 10.15 x 10.5 mm, Number of individual labels: 10

---

#### Marker for terminal blocks - UC-TM 10 CUS - 0824605



Marker for terminal blocks, can be ordered: by sheet, white, labeled according to customer specifications, mounting type: snap into tall marker groove, for terminal block width: 10.2 mm, lettering field size: 9.6 x 10.5 mm, Number of individual labels: 48

---

#### Marker for terminal blocks - UCT-TM 10 CUS - 0829623



Marker for terminal blocks, can be ordered: by sheet, white, labeled according to customer specifications, mounting type: snap into tall marker groove, for terminal block width: 10.2 mm, lettering field size: 8.9 x 9.6 mm, Number of individual labels: 36



## Relay Module - PLC-RSC- 24DC/21-21/MS - 2910502

### Accessories

#### Zack marker strip - ZB 12 CUS - 0824942



Zack marker strip, can be ordered: Strip, white, labeled according to customer specifications, mounting type: snap into tall marker groove, for terminal block width: 12.2 mm, lettering field size: 10.5 x 12.15 mm, Number of individual labels: 5

#### Zack marker strip - ZB 12,LGS:L1-N,PE - 0812146



Zack marker strip, Strip, white, labeled, printed horizontally: L1, L2, L3, N, PE, mounting type: snap into tall marker groove, for terminal block width: 12.2 mm, lettering field size: 10.5 x 12.15 mm, Number of individual labels: 5

#### Marker for terminal blocks - UC-TM 12 CUS - 0824613



Marker for terminal blocks, can be ordered: by sheet, white, labeled according to customer specifications, mounting type: snap into tall marker groove, for terminal block width: 12 mm, lettering field size: 11.45 x 10.5 mm, Number of individual labels: 40

#### Marker for terminal blocks - UCT-TM 12 CUS - 0829630



Marker for terminal blocks, can be ordered: by sheet, white, labeled according to customer specifications, mounting type: snap into tall marker groove, for terminal block width: 12 mm, lettering field size: 10.8 x 9.6 mm, Number of individual labels: 30

### Partition plate

#### Separating plate - PLC-ATP BK - 2966841



Separating plate, 2 mm thick, required at the start and end of a PLC terminal strip. Furthermore, it is used for: visual separation of groups, safe isolation of different voltages of neighboring PLC relays in acc. with DIN VDE 0106-101, isolation

### Power module

## Relay Module - PLC-RSC- 24DC/21-21/MS - 2910502

### Accessories

Power terminal block - PLC-ESK GY - 2966508



Power terminal block, for the input of up to four potentials, for mounting on NS 35/7.5

---

### Screwdriver tools

Screwdriver - SZF 1-0,6X3,5 - 1204517



Actuation tool, for ST terminal blocks, also suitable for use as a bladed screwdriver, size: 0.6 x 3.5 x 100 mm, 2-component grip, with non-slip grip

---

### Terminal marking

Zack marker strip - ZB 10:UNBEDRUCKT - 1053001



Zack marker strip, Strip, white, unlabeled, can be labeled with: PLOTMARK, CMS-P1-PLOTTER, mounting type: snap into tall marker groove, for terminal block width: 10.2 mm, lettering field size: 10.5 x 10.15 mm, Number of individual labels: 10

---

Marker for terminal blocks - UC-TM 10 - 0818069



Marker for terminal blocks, Sheet, white, unlabeled, can be labeled with: BLUEMARK ID COLOR, BLUEMARK ID, BLUEMARK CLED, PLOTMARK, CMS-P1-PLOTTER, mounting type: snap into tall marker groove, for terminal block width: 10.2 mm, lettering field size: 9.6 x 10.5 mm, Number of individual labels: 48

---

Marker for terminal blocks - UCT-TM 10 - 0829142



Marker for terminal blocks, Sheet, white, unlabeled, can be labeled with: TOPMARK NEO, TOPMARK LASER, BLUEMARK ID COLOR, BLUEMARK ID, BLUEMARK CLED, THERMOMARK PRIME, THERMOMARK CARD 2.0, THERMOMARK CARD, mounting type: snap into tall marker groove, for terminal block width: 10.2 mm, lettering field size: 8.9 x 9.6 mm, Number of individual labels: 36

## Relay Module - PLC-RSC- 24DC/21-21/MS - 2910502

### Accessories

#### Zack marker strip - ZB 12:UNPRINTED - 0812120



Zack marker strip, Strip, white, unlabeled, can be labeled with: PLOTMARK, CMS-P1-PLOTTER, mounting type: snap into tall marker groove, for terminal block width: 12.2 mm, lettering field size: 12 x 10.5 mm, Number of individual labels: 5

---

#### Marker for terminal blocks - UC-TM 12 - 0819194



Marker for terminal blocks, Sheet, white, unlabeled, can be labeled with: BLUEMARK ID COLOR, BLUEMARK ID, BLUEMARK CLED, PLOTMARK, CMS-P1-PLOTTER, mounting type: snap into tall marker groove, for terminal block width: 12 mm, lettering field size: 11.45 x 10.5 mm, Number of individual labels: 40

---

#### Marker for terminal blocks - UCT-TM 12 - 0829144



Marker for terminal blocks, Sheet, white, unlabeled, can be labeled with: TOPMARK NEO, TOPMARK LASER, BLUEMARK ID COLOR, BLUEMARK ID, BLUEMARK CLED, THERMOMARK PRIME, THERMOMARK CARD 2.0, THERMOMARK CARD, mounting type: snap into tall marker groove, for terminal block width: 12 mm, lettering field size: 10.8 x 9.6 mm, Number of individual labels: 30

---

### Spare parts

#### Relay base - PLC-BSC- 24DC/21-21/H - 1011983



14 mm PLC basic terminal block without relay, for mounting on DIN rail NS 35/7,5, Screw connection, 2 PDT, Input voltage 24 V DC

---

#### Single relay - REL-MR- 24DC/21-21/MS - 2987943



Plug-in miniature relay, with power contact, 2 PDTs, test button, mechanical switch position indicator, status LED, freewheeling diode, polarity A1+, A2, input voltage 24 V DC

Phoenix Contact 2020 © - all rights reserved  
<http://www.phoenixcontact.com>

PHOENIX CONTACT GmbH & Co. KG  
Flachsmarktstr. 8  
32825 Blomberg  
Germany  
Tel. +49 5235 300  
Fax +49 5235 3 41200  
<http://www.phoenixcontact.com>

## X-ON Electronics

Largest Supplier of Electrical and Electronic Components

*Click to view similar products for [Industrial Relays](#) category:*

*Click to view products by [Phoenix Contact](#) manufacturer:*

Other Similar products are found below :

[6-1617801-8](#) [6-1618107-9](#) [7-1618273-3](#) [EV250-4A-02](#) [EV250-6A-01](#) [FCA-125-CX8](#) [FCA-325-159](#) [FCA-410-138](#) [8000-S3121](#) [8-1618273-6](#)  
[8-1618393-1](#) [GCA63A220VAC60HZ](#) [GCA63A277VAC60HZ](#) [GCA63A600VAC60HZ](#) [1-1672275-3](#) [1-1833005-4](#) [H-16/S1](#) [A711Z](#) [H-8C](#)  
[H-8/S11](#) [H-8/S68](#) [ACC530U20](#) [ACC730U30](#) [RF303ZM4-12](#) [DH18DA](#) [1423675-8](#) [AR4-15F13-C01](#) [AR7-41F11](#) [AVR907](#) [15732A200](#)  
[B07B032AC1-0329](#) [B329](#) [B490A](#) [1618279-1](#) [BHR124Y](#) [1810DDB-SX](#) [N417](#) [P30C42A12D1-120](#) [2-1617748-6](#) [2-1618375-1](#) [2-1618396-6](#)  
[2-1618398-1](#) [JMAPD-5XL](#) [JMGACD-5M](#) [JMGSC-5LW](#) [JMGSCD-5L](#) [PBO-18A1218](#) [PBO-40A3040](#) [K8DSPH1200480VAC](#) [KA-3C-12A](#)