

Feed-through header - MSTBO 2,5/ 3 G1R THRR44 BK - 2915229

Please be informed that the data shown in this PDF Document is generated from our Online Catalog. Please find the complete data in the user's documentation. Our General Terms of Use for Downloads are valid (<http://phoenixcontact.com/download>)



PCB headers, number of positions: 3, pitch: 5 mm, color: black, contact surface: Tin, pin layout: Linear pinning, solder pin [P]: 3.5 mm

Your advantages

- ✔ For ME/ME MAX electronics housing
- ✔ 5 mm pitch
- ✔ Plug-in direction orthogonal to the PCB
- ✔ Orthogonal headers for through hole reflow process
- ✔ 2, 3, and 4-pos.
- ✔ Made from high-temperature-resistant polyamide for use in lead-free soldering processes.
- ✔ Supplied taped as standard, in bulk as an option
- ✔ Integrated suction surface



Key Commercial Data

Packing unit	170 pc
Minimum order quantity	170 pc
GTIN	
GTIN	4046356157995

Technical data

Dimensions

Pitch	5 mm
Dimension a	10 mm
Length of the solder pin	3.5 mm
Pin spacing	5.00 mm

General

Range of articles	MSTBO 2,5/..-G1R-THR
Insulating material group	I

Feed-through header - MSTBO 2,5/ 3 G1R THRR44 BK - 2915229

Technical data

General

Rated surge voltage (III/3)	4 kV
Rated surge voltage (III/2)	4 kV
Rated surge voltage (II/2)	4 kV
Rated voltage (III/3)	250 V
Rated voltage (III/2)	320 V
Rated voltage (II/2)	400 V
Connection in acc. with standard	EN-VDE
Nominal current I_N	16 A
Maximum load current	16 A
Insulating material	PA
Flammability rating according to UL 94	V0
Color	black
Number of positions	3

Standards and Regulations

Connection in acc. with standard	EN-VDE
	CUL
Flammability rating according to UL 94	V0

Environmental Product Compliance

China RoHS	Environmentally friendly use period: unlimited = EFUP-e
	No hazardous substances above threshold values

Drawings

Feed-through header - MSTBO 2,5/ 3 G1R THRR44 BK - 2915229

Drilling diagram

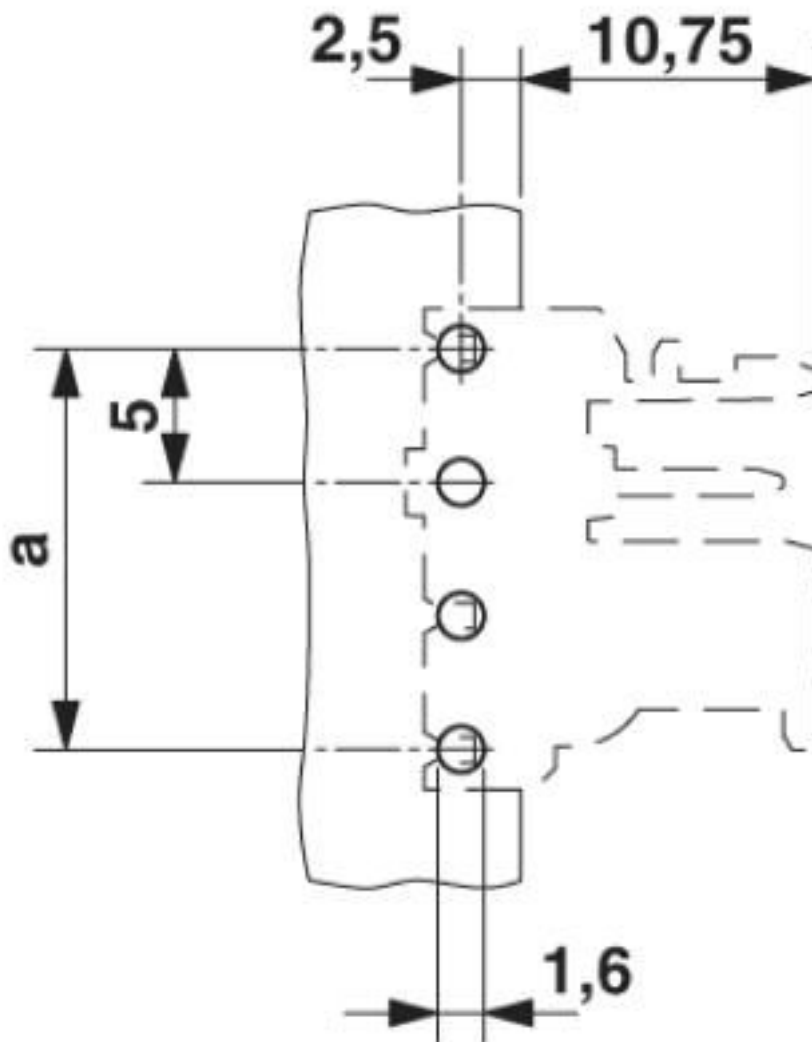

Feed-through header - MSTBO 2,5/ 3 G1R THRR44 BK - 2915229

Dimensional drawing

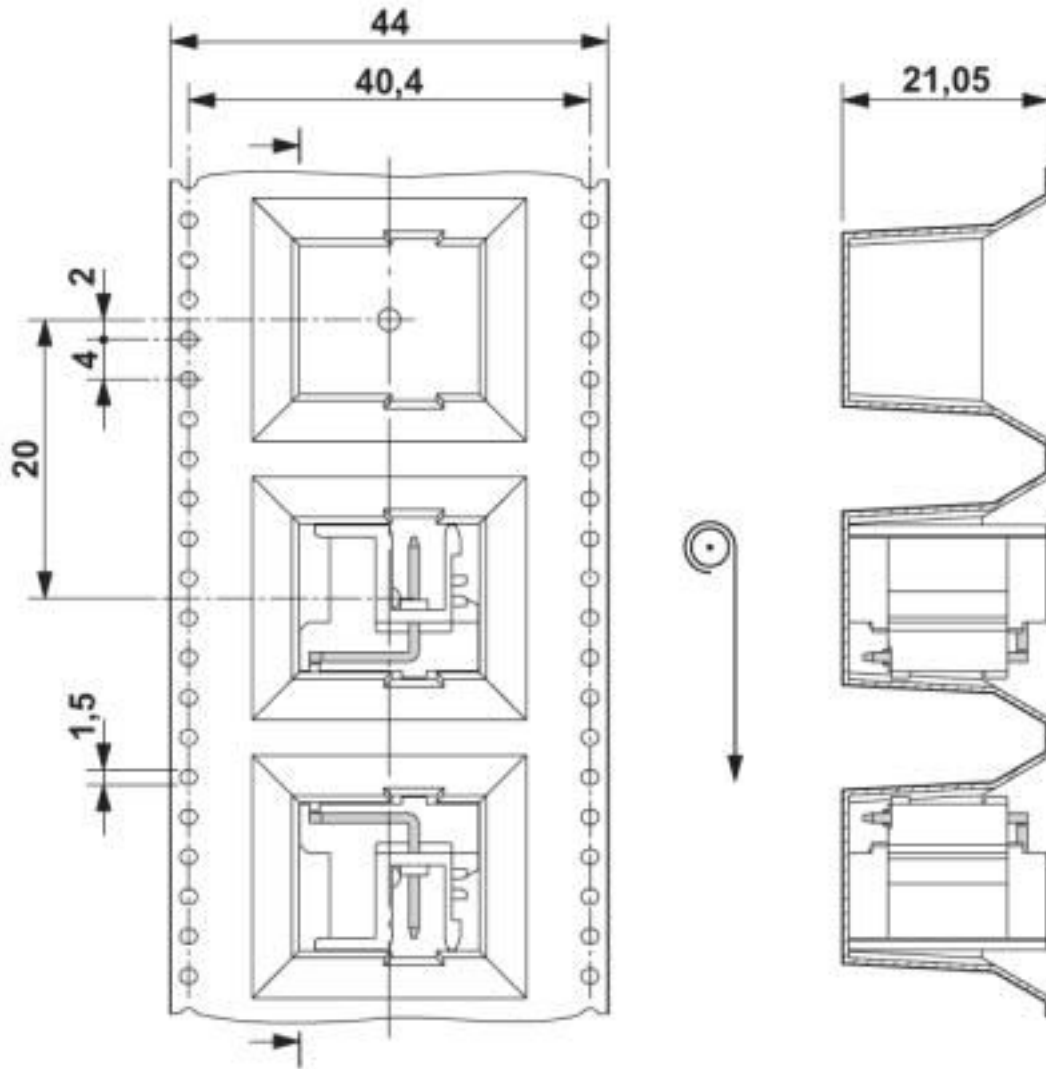

Feed-through header - MSTBO 2,5/ 3 G1R THRR44 BK - 2915229

Diagram

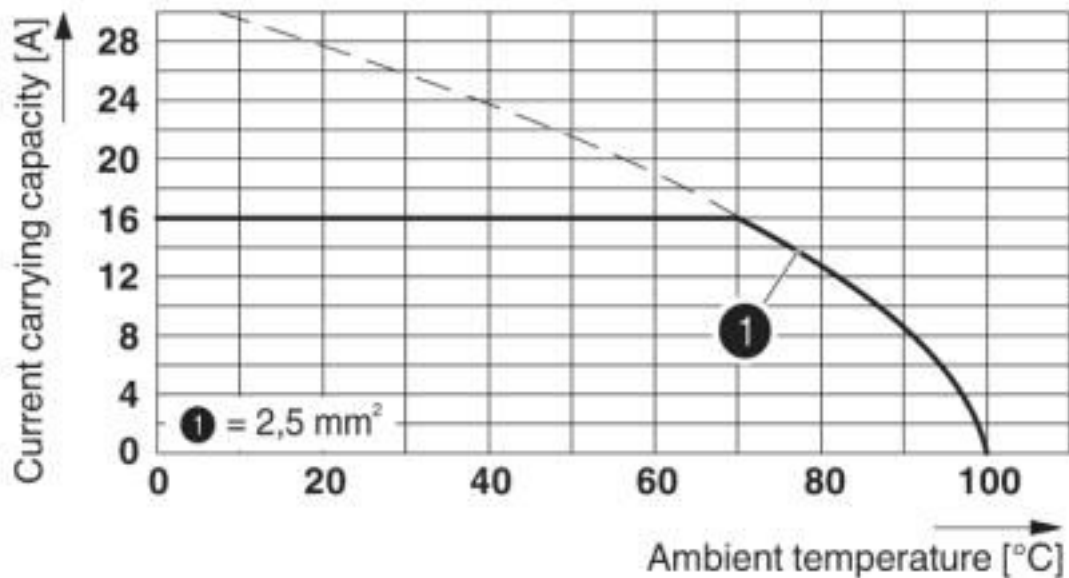

Dimensional drawing

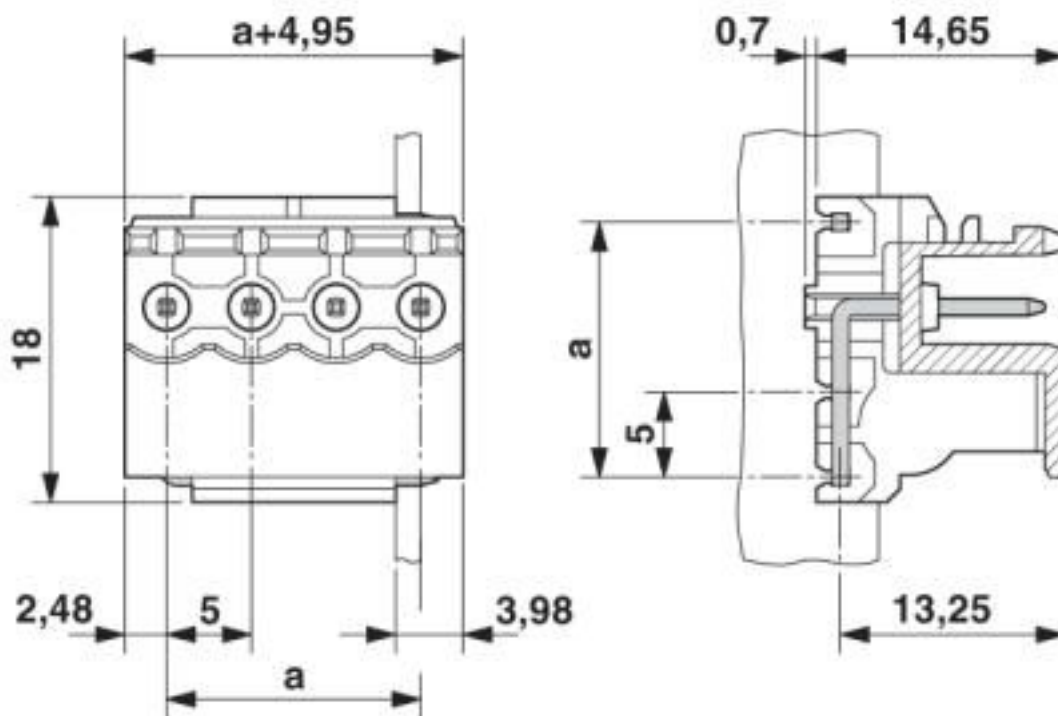

Feed-through header - MSTBO 2,5/ 3 G1R THRR44 BK - 2915229

Dimensional drawing

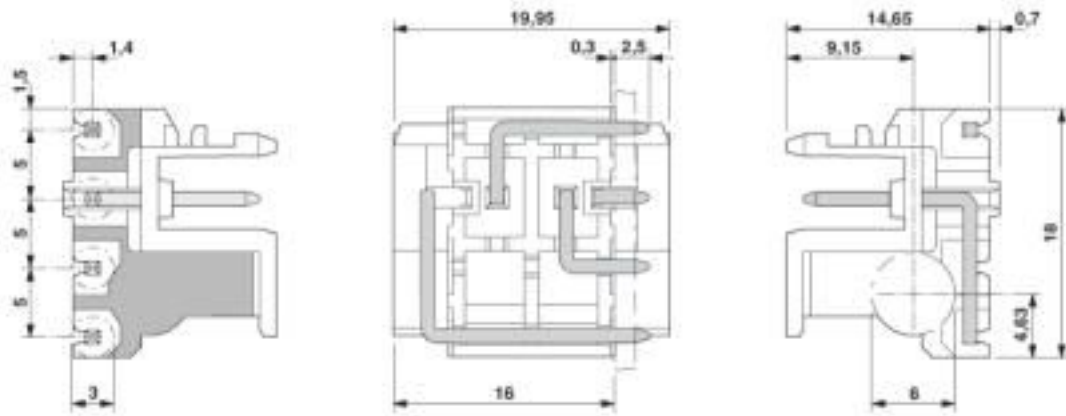

Schematic diagram

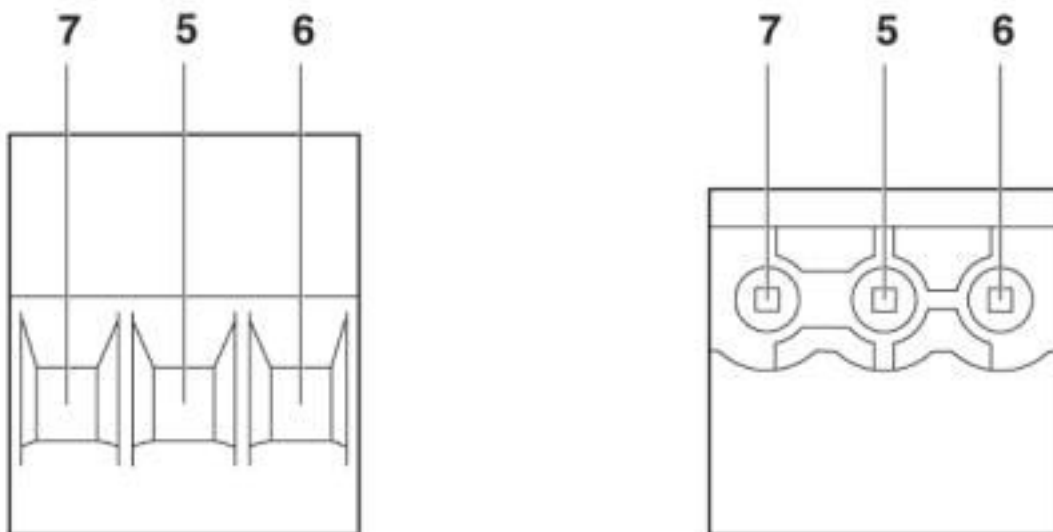

Pin assignment right

Classifications

eCl@ss

eCl@ss 10.0.1	27440402
eCl@ss 4.0	27260700
eCl@ss 4.1	27260700
eCl@ss 5.0	27260700
eCl@ss 5.1	27260700
eCl@ss 6.0	27260700
eCl@ss 7.0	27440402
eCl@ss 8.0	27440402
eCl@ss 9.0	27440402

Feed-through header - MSTBO 2,5/ 3 G1R THRR44 BK - 2915229

Classifications

ETIM

ETIM 3.0	EC001121
ETIM 4.0	EC002637
ETIM 5.0	EC002637
ETIM 6.0	EC002637
ETIM 7.0	EC002637

UNSPSC

UNSPSC 6.01	30211801
UNSPSC 7.0901	39121432
UNSPSC 11	34131203
UNSPSC 12.01	39121432
UNSPSC 13.2	39121409
UNSPSC 18.0	39121409
UNSPSC 19.0	39121409
UNSPSC 20.0	39121409
UNSPSC 21.0	39121409

Approvals

Approvals

Approvals

cULus Recognized / EAC

Ex Approvals

Approval details

cULus Recognized		http://database.ul.com/cgi-bin/XYV/template/LISEXT/1FRAME/index.htm	E60425-20050718
	B	D	
Nominal voltage UN	300 V	300 V	
Nominal current IN	16 A	10 A	

EAC		B.01687
-----	-------------------------------------------------------------------------------------	---------

Feed-through header - MSTBO 2,5/ 3 G1R THRR44 BK - 2915229

Accessories

Accessories

Coding element

Coding section - CR MSTBO-G1 - 2199618



Coding section, inserted into the recess in the header or the inverted plug, red insulating material

Necessary add-on products

Printed-circuit board connector - MSTBT 2,5/ 3-ST KMGY - 1971947



PCB connector, nominal current: 12 A, rated voltage (III/2): 320 V, nominal cross section: 2.5 mm², number of positions: 3, pitch: 5 mm, connection method: Screw connection with tension sleeve, color: light gray, contact surface: Tin, pin layout: Linear pinning

Printed-circuit board connector - FKCT 2,5/ 3-ST KMGY - 1998263



PCB connector, nominal current: 12 A, rated voltage (III/2): 320 V, nominal cross section: 2.5 mm², number of positions: 3, pitch: 5 mm, connection method: Push-in spring connection, color: light gray, contact surface: Tin

Printed-circuit board connector - MSTBT 2,5/ 3-ST - 1779848



PCB connector, nominal current: 12 A, rated voltage (III/2): 320 V, nominal cross section: 2.5 mm², number of positions: 3, pitch: 5 mm, connection method: Screw connection with tension sleeve, color: green, contact surface: Tin

Printed-circuit board connector - MSTBT 2,5 HC/ 3-ST - 1926248



PCB connector, nominal current: 16 A, rated voltage (III/2): 320 V, nominal cross section: 2.5 mm², number of positions: 3, pitch: 5 mm, connection method: Screw connection with tension sleeve, color: green, contact surface: Tin, The T-shape of the MSTBT plug distributes the height uniformly over the upper and lower sides of the printed circuit board

Feed-through header - MSTBO 2,5/ 3 G1R THRR44 BK - 2915229

Accessories

Printed-circuit board connector - FKCT 2,5/ 3-ST - 1909223



PCB connector, nominal current: 12 A, rated voltage (III/2): 320 V, nominal cross section: 2.5 mm², number of positions: 3, pitch: 5 mm, connection method: Push-in spring connection, color: green, contact surface: Tin

Additional products

Printed-circuit board connector - TVFKC 1,5/ 3-ST - 1713842

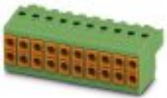

PCB connector, nominal current: 10 A, rated voltage (III/2): 320 V, nominal cross section: 1.5 mm², number of positions: 3, pitch: 5 mm, connection method: Push-in spring connection, color: green, contact surface: Tin

Printed-circuit board connector - TVFKCL 1,5/ 3-ST - 1715934

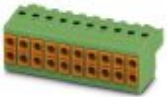

PCB connector, nominal current: 10 A, rated voltage (III/2): 320 V, nominal cross section: 1.5 mm², number of positions: 3, pitch: 5 mm, connection method: Push-in spring connection, color: green, contact surface: Tin

Plug - QC 1,5/ 3-ST - 1717974



PCB connector, nominal current: 12 A, rated voltage (III/2): 630 V, nominal cross section: 1.5 mm², number of positions: 3, pitch: 5 mm, connection method: Displacement connection, color: green, contact surface: Tin

Printed-circuit board connector - FKCN 2,5/ 3-ST - 1732755



PCB connector, nominal current: 12 A, rated voltage (III/2): 320 V, nominal cross section: 2.5 mm², number of positions: 3, pitch: 5 mm, connection method: Push-in spring connection, color: green, contact surface: Tin

Feed-through header - MSTBO 2,5/ 3 G1R THRR44 BK - 2915229

Accessories

Printed-circuit board connector - MSTB 2,5/ 3-ST - 1754465

PCB connector, nominal current: 12 A, rated voltage (III/2): 320 V, nominal cross section: 2.5 mm², number of positions: 3, pitch: 5 mm, connection method: Screw connection with tension sleeve, color: green, contact surface: Tin



Printed-circuit board connector - MSTBP 2,5/ 3-ST - 1765784

PCB connector, nominal current: 12 A, rated voltage (III/2): 320 V, nominal cross section: 2.5 mm², number of positions: 3, pitch: 5 mm, connection method: Screw connection with tension sleeve, color: green, contact surface: Tin



Printed-circuit board connector - SMSTB 2,5/ 3-ST - 1768778

PCB connector, nominal current: 12 A, rated voltage (III/2): 320 V, nominal cross section: 2.5 mm², number of positions: 3, pitch: 5 mm, connection method: Screw connection with tension sleeve, color: green, contact surface: Tin



Printed-circuit board connector - FRONT-MSTB 2,5/ 3-ST - 1779424

PCB connector, nominal current: 12 A, rated voltage (III/2): 320 V, nominal cross section: 2.5 mm², number of positions: 3, pitch: 5 mm, connection method: Front screw connection, color: green, contact surface: Tin



Printed-circuit board connector - MSTBT 2,5/ 3-ST - 1779848

PCB connector, nominal current: 12 A, rated voltage (III/2): 320 V, nominal cross section: 2.5 mm², number of positions: 3, pitch: 5 mm, connection method: Screw connection with tension sleeve, color: green, contact surface: Tin



Feed-through header - MSTBO 2,5/ 3 G1R THRR44 BK - 2915229

Accessories

Printed-circuit board connector - MVSTBR 2,5/ 3-ST - 1792029



PCB connector, nominal current: 12 A, rated voltage (III/2): 320 V, nominal cross section: 2.5 mm², number of positions: 3, pitch: 5 mm, connection method: Screw connection with tension sleeve, color: green, contact surface: Tin

Printed-circuit board connector - MVSTBW 2,5/ 3-ST - 1792537



PCB connector, nominal current: 12 A, rated voltage (III/2): 320 V, nominal cross section: 2.5 mm², number of positions: 3, pitch: 5 mm, connection method: Screw connection with tension sleeve, color: green, contact surface: Tin

Printed-circuit board connector - FKCT 2,5/ 3-ST - 1909223



PCB connector, nominal current: 12 A, rated voltage (III/2): 320 V, nominal cross section: 2.5 mm², number of positions: 3, pitch: 5 mm, connection method: Push-in spring connection, color: green, contact surface: Tin

Printed-circuit board connector - FKCVR 2,5/ 3-ST - 1909728



PCB connector, nominal current: 12 A, rated voltage (III/2): 320 V, nominal cross section: 2.5 mm², number of positions: 3, pitch: 5 mm, connection method: Push-in spring connection, color: green, contact surface: Tin

Printed-circuit board connector - FKCVW 2,5/ 3-ST - 1910047



PCB connector, nominal current: 12 A, rated voltage (III/2): 320 V, nominal cross section: 2.5 mm², number of positions: 3, pitch: 5 mm, connection method: Push-in spring connection, color: green, contact surface: Tin

Feed-through header - MSTBO 2,5/ 3 G1R THRR44 BK - 2915229

Accessories

Printed-circuit board connector - FKC 2,5/ 3-ST - 1910364

PCB connector, nominal current: 12 A, rated voltage (III/2): 320 V, nominal cross section: 2.5 mm², number of positions: 3, pitch: 5 mm, connection method: Push-in spring connection, color: green, contact surface: Tin



Printed-circuit board connector - QC 1/ 3-ST-BUS - 1921683

PCB connector, nominal current: 10 A, rated voltage (III/2): 630 V, nominal cross section: 1 mm², number of positions: 3, pitch: 5 mm, connection method: Displacement connection, color: green, contact surface: Tin, The plug allows conductors to be looped through from module to module, without interruption



Printed-circuit board connector - FKCS 2,5/ 3-ST - 1974740

PCB connector, nominal current: 12 A, rated voltage (III/2): 320 V, nominal cross section: 2.5 mm², number of positions: 3, pitch: 5 mm, connection method: Push-in spring connection, color: green, contact surface: Tin



Phoenix Contact 2020 © - all rights reserved
<http://www.phoenixcontact.com>

PHOENIX CONTACT GmbH & Co. KG
Flachsmarktstr. 8
32825 Blomberg
Germany
Tel. +49 5235 300
Fax +49 5235 3 41200
<http://www.phoenixcontact.com>

X-ON Electronics

Largest Supplier of Electrical and Electronic Components

Click to view similar products for [Pluggable Terminal Blocks](#) category:

Click to view products by [Phoenix Contact](#) manufacturer:

Other Similar products are found below :

[57.510.0053](#) [MC 1.5/ 6-ST-3.5 GY AU](#) [734-104](#) [734-302](#) [8-141-P](#) [8426620000](#) [860505](#) [860810](#) [GBPACX-12](#) [93.731.4953.0](#) [PV05-5,08-K](#)
[PVP02-5,00](#) [PVP03-3,50](#) [PVP04-3,50](#) [PVS02-5,00](#) [1-1986160-3](#) [1377680000](#) [1531000000](#) [1546228-5](#) [ELFH16150](#) [ELFP03110](#)
[ELFP10210](#) [ELFT06250](#) [ELVP03100](#) [1700101](#) [1700410](#) [1700425](#) [1702246](#) [1705229](#) [1710175](#) [1714537](#) [1717806](#) [1719600](#) [1728941](#)
[1734692](#) [1734795](#) [1736036](#) [1740194](#) [1740291](#) [1740628](#) [1740990](#) [1746952](#) [1750207](#) [1752441](#) [1752865](#) [1754115](#) [1754144](#) [1756913](#)
[1760051](#) [1760336](#)