

Single relay - REL-MR- 24DC/21AU - 2961121

Please be informed that the data shown in this PDF Document is generated from our Online Catalog. Please find the complete data in the user's documentation. Our General Terms of Use for Downloads are valid (<http://phoenixcontact.com/download>)

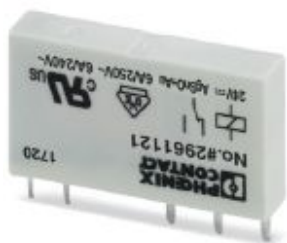

Plug-in miniature power relay, with multi-layer gold contact, 1 PDT, input voltage 24 V DC

Your advantages

- Safe isolation according to DIN EN 50178 between coil and contact
- High degree of protection up to RT III depending on type (wash-proof)
- Power contacts up to 6 A



Key Commercial Data

Packing unit	10 pc
Minimum order quantity	10 pc
GTIN	 4 017918 130879
GTIN	4017918130879
Sales Key	08

Technical data

Dimensions

Width	5 mm
Height	28 mm
Depth	15 mm

Ambient conditions

Ambient temperature (operation)	-40 °C ... 85 °C
Ambient temperature (storage/transport)	-40 °C ... 85 °C
Degree of protection	RT III

Coil side

Nominal input voltage U_N	24 V DC
Input voltage range in reference to U_N	see diagram

Single relay - REL-MR- 24DC/21AU - 2961121

Technical data

Coil side

Typical input current at U_N	7 mA
Typical response time	5 ms
Typical release time	2.5 ms
Coil resistance	3390 Ω \pm 10 % (at 20 °C)
Power dissipation for nominal condition	0.17 W

Contact side

Contact type	1 PDT
Type of switch contact	Single contact
Contact material	AgSnO, hard gold-plated
Maximum switching voltage	30 V AC 36 V DC
Minimum switching voltage	100 mV (at 10 mA)
Min. switching current	1 mA (at 24 V)
Maximum inrush current	50 mA
Limiting continuous current	50 mA
Interrupting rating (ohmic load) max.	1.2 W (at 24 V DC)

Contact side (with destroyed gold layer)

Contact material	AgSnO
Note	the following values are applicable if a gold layer is destroyed
Maximum switching voltage	250 V AC
Minimum switching voltage	5 V (at 100 mA)
Limiting continuous current	6 A
Min. switching current	10 mA (at 12 V)
Interrupting rating (ohmic load) max.	140 W (at 24 V DC) 20 W (at 48 V DC) 18 W (at 60 V DC) 23 W (at 110 V DC) 40 W (at 220 V DC)
Switching capacity	1500 VA (for 250 V AC) 2 A (at 24 V, DC13) 0.2 A (at 110 V, DC13) 0.1 A (at 220 V, DC13) 3 A (at 24 V, AC15) 3 A (at 120 V, AC15) 3 A (at 230 V, AC15)

General

Test voltage relay winding/relay contact	4 kV AC (50 Hz, 1 min.)
Operating mode	100% operating factor
Mechanical service life	2x 10 ⁷ cycles

Single relay - REL-MR- 24DC/21AU - 2961121

Technical data

General

Mounting position	any
Assembly instructions	In rows with zero spacing

Connection data

Connection method	Solder connection
-------------------	-------------------

Standards and Regulations

Connection in acc. with standard	CUL
Standards/regulations	IEC 60664
	EN 50178
	EN 61810-1
Pollution degree	3
Overvoltage category	III

Environmental Product Compliance

China RoHS	Environmentally friendly use period: unlimited = EFUP-e
	No hazardous substances above threshold values

Drawings

Drilling diagram

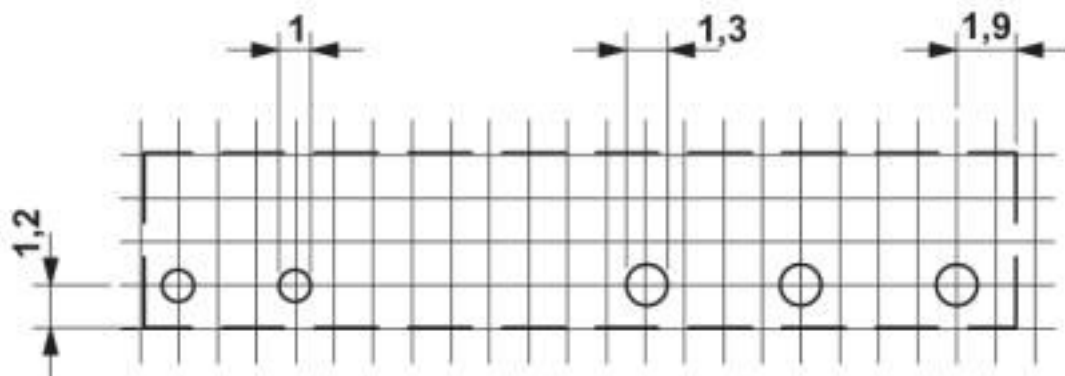

a = pitch division 1.25 mm and 1.27 mm

Single relay - REL-MR- 24DC/21AU - 2961121

Diagram

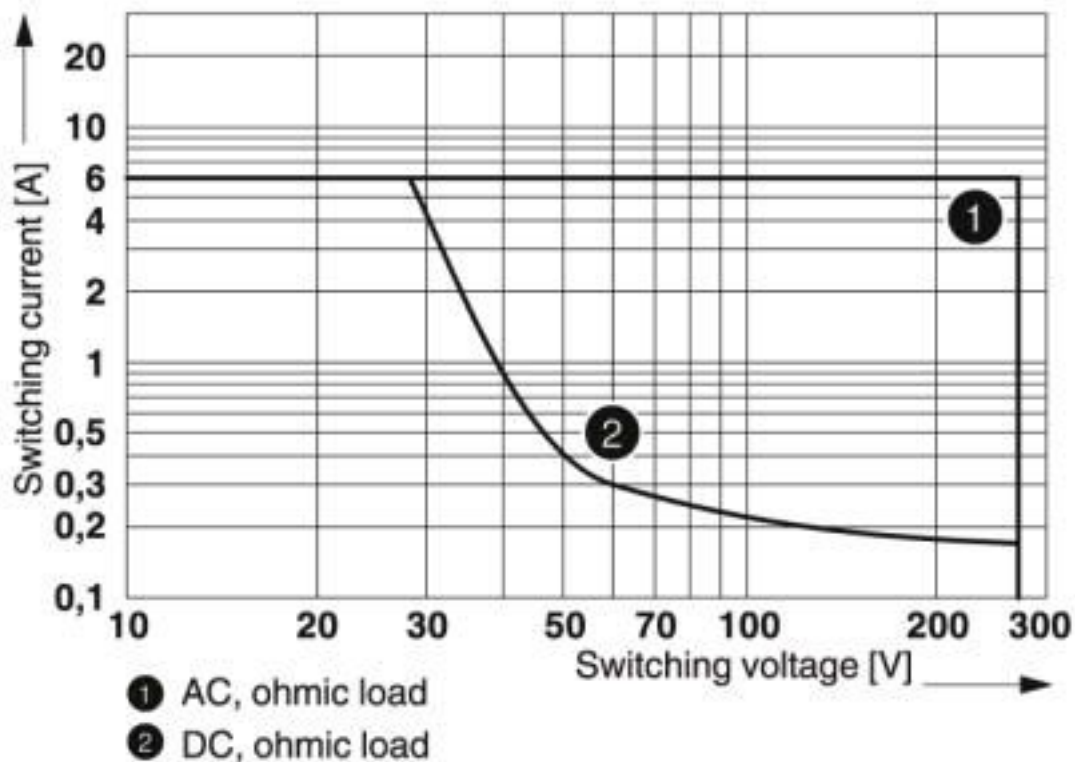

Interrupting rating

Dimensional drawing

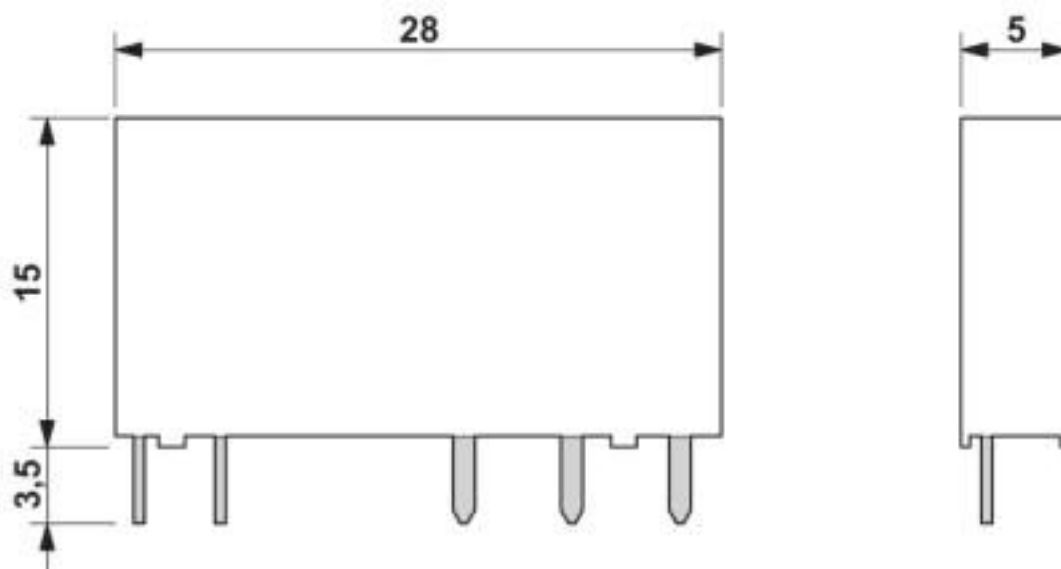

Single relay - REL-MR- 24DC/21AU - 2961121

Circuit diagram

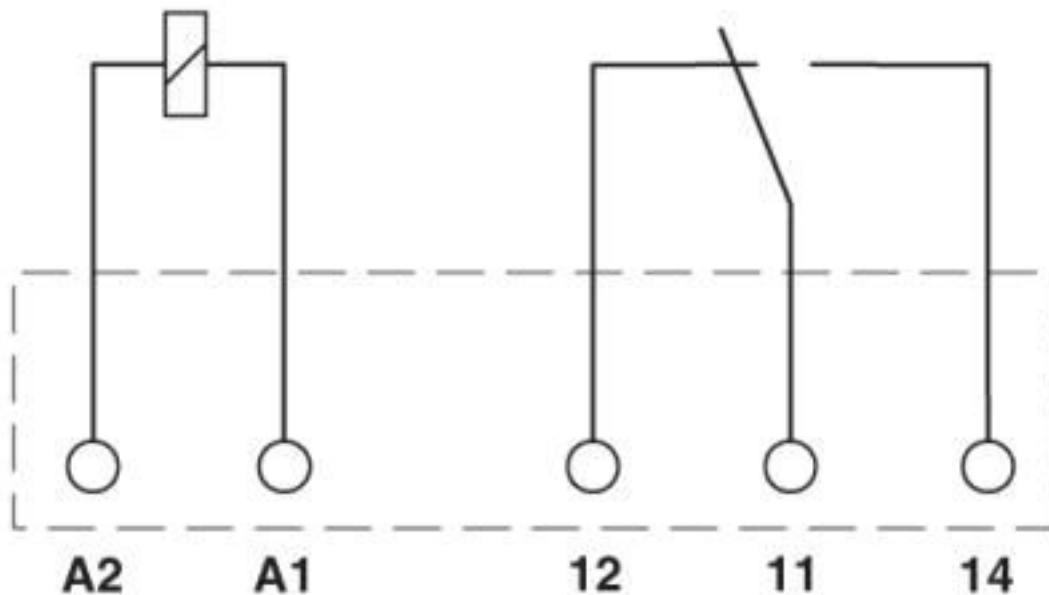

Classifications

eCl@ss

eCl@ss 10.0.1	27371601
eCl@ss 4.0	27371100
eCl@ss 4.1	27371100
eCl@ss 5.0	27371600
eCl@ss 5.1	27371600
eCl@ss 6.0	27371600
eCl@ss 7.0	27371601
eCl@ss 8.0	27371601
eCl@ss 9.0	27371601

ETIM

ETIM 2.0	EC001437
ETIM 3.0	EC001437
ETIM 4.0	EC001437
ETIM 5.0	EC001437
ETIM 6.0	EC001437
ETIM 7.0	EC001437

UNSPSC

UNSPSC 6.01	30211916
UNSPSC 7.0901	39121515
UNSPSC 11	39121515
UNSPSC 12.01	39121515

Single relay - REL-MR- 24DC/21AU - 2961121

Classifications

UNSPSC

UNSPSC 13.2	39122334
UNSPSC 18.0	39122334
UNSPSC 19.0	39122334
UNSPSC 20.0	39122334
UNSPSC 21.0	39122334

Approvals

Approvals

Approvals

PRS / EAC / EAC / UL Recognized / UL Recognized / cUL Recognized / cUL Recognized / VDE Zeichengenehmigung / VDE Zeichengenehmigung

Ex Approvals

Approval details

PRS		http://www.prs.pl/	TE/2109/880590/16
-----	---	---	-------------------

EAC			TR_TS_D_00573_c
-----	---	--	-----------------

EAC			RU*C- DE.*08.B.00010
-----	---	--	-------------------------

UL Recognized		http://database.ul.com/cgi-bin/XYV/template/LISEXT/1FRAME/index.htm	FILE E 172140
---------------	---	---	---------------

UL Recognized		http://database.ul.com/cgi-bin/XYV/template/LISEXT/1FRAME/index.htm	FILE E 172140
---------------	---	---	---------------

cUL Recognized		http://database.ul.com/cgi-bin/XYV/template/LISEXT/1FRAME/index.htm	FILE E 172140
----------------	---	---	---------------

Single relay - REL-MR- 24DC/21AU - 2961121

Approvals

cUL Recognized		http://database.ul.com/cgi-bin/XYV/template/LISEXT/1FRAME/index.htm	FILE E 172140
----------------	--	---	---------------

VDE Zeichengenehmigung		http://www2.vde.com/de/Institut/Online-Service/VDE-gepruefteProdukte/Seiten/Online-Suche.aspx	40010212
------------------------	--	---	----------

VDE Zeichengenehmigung		http://www2.vde.com/de/Institut/Online-Service/VDE-gepruefteProdukte/Seiten/Online-Suche.aspx	40032864
------------------------	--	---	----------

Accessories

Additional products

Relay base - PLC-BPT- 24DC/21 - 2900445



6.2 mm PLC basic terminal block with push-in connection, without relay or solid-state relay, for mounting on DIN rail NS 35/7,5, 1 PDT, input voltage 24 V DC

Relay base - PLC-BSP- 24DC/21 - 2967219



6.2 mm PLC basic terminal block with spring-cage connection, without relay or solid-state relay, for mounting on DIN rail NS 35/7,5, 1 PDT, input voltage 24 V DC

Relay base - PLC-BSC- 24DC/21 - 2966016



6.2 mm PLC basic terminal block with screw connection, without relays or solid-state relay, for mounting on DIN rail NS 35/7,5, 1 PDT, input voltage 24 V DC

Single relay - REL-MR- 24DC/21AU - 2961121

Accessories

Relay base - PLC-BPT- 24UC/21 - 2900446



6.2 mm PLC basic terminal block with push-in connection, without relay or solid-state relay, for mounting on DIN rail NS 35/7,5, 1 PDT, input voltage 24 V AC/DC

Relay base - PLC-BSP- 24UC/21 - 2967222



6.2 mm PLC basic terminal block with spring-cage connection, without relay or solid-state relay, for mounting on DIN rail NS 35/7,5, 1 PDT, input voltage 24 V AC/DC

Relay base - PLC-BSC- 24UC/21 - 2966029



6.2 mm PLC basic terminal block with screw connection, without relay or solid-state relay, for mounting on DIN rail NS 35/7,5, 1 PDT, input voltage 24 V AC/DC

Basic terminal block - PLC-BSC- 36DC/21 - 2966964

Basic terminal block

Relay base - PLC-BPT- 48DC/21 - 2900447



6.2 mm PLC basic terminal block with push-in connection, without relay or solid-state relay, for mounting on DIN rail NS 35/7,5, 1 PDT, input voltage 48 V DC

Relay base - PLC-BSP- 48DC/21 - 2967329



6.2 mm PLC basic terminal block with spring-cage connection, without relay or solid-state relay, for mounting on DIN rail NS 35/7,5, 1 PDT, input voltage 48 V DC

Single relay - REL-MR- 24DC/21AU - 2961121

Accessories

Relay base - PLC-BSC- 48DC/21 - 2966090



6.2 mm PLC basic terminal block with screw connection, without relay or solid-state relay, for mounting on DIN rail NS 35/7,5, 1 PDT, input voltage 48 V DC

Relay base - PLC-BPT- 24DC/ 1/SEN - 2900262



6.2 mm PLC basic terminal block for input functions with push-in connection, without relay or solid-state relay, for mounting on DIN rail NS 35/7,5, with sensor supply voltage distribution (BB), 1 N/O contact, input voltage 24 V DC

Relay base - PLC-BSP- 24DC/ 1/SEN - 2967206



6.2 mm PLC basic terminal block for input functions with spring-cage connection, without relay or solid-state relay, for mounting on DIN rail NS 35/7,5, with sensor supply voltage distribution (BB), 1 N/O contact, input voltage 24 V DC

Relay base - PLC-BSC- 24DC/ 1/SEN - 2966061



6.2 mm PLC basic terminal block for input functions with screw connection, without relay or solid-state relay, for mounting on DIN rail NS 35/7,5, with sensor supply voltage distribution (BB), 1 N/O contact, input voltage 24 V DC

Relay base - PLC-BPT- 24DC/ 1/ACT - 2900449



6.2 mm PLC basic terminal block for output functions with push-in connection, without relay or solid-state relay, for mounting on DIN rail NS 35/7,5, with load return line connection (BB), 1 N/O contact, input voltage 24 V DC

Single relay - REL-MR- 24DC/21AU - 2961121

Accessories

Relay base - PLC-BSP- 24DC/ 1/ACT - 2967196



6.2 mm PLC basic terminal block for output functions with spring-cage connection, without relay or solid-state relay, for mounting on DIN rail NS 35/7,5, with load return line connection (BB), 1 N/O contact, input voltage 24 V DC

Relay base - PLC-BSC- 24DC/ 1/ACT - 2966058



6.2 mm PLC basic terminal block for output functions with screw connection, without relay or solid-state relay, for mounting on DIN rail NS 35/7,5, with load return line connection (BB), 1 N/O contact, input voltage 24 V DC

Relay base - PLC-BPT- 24UC/ 1/ACT - 2900450



6.2 mm PLC basic terminal block for output functions with push-in connection, without relay or solid-state relay, for mounting on DIN rail NS 35/7,5, with load return line connection (BB), 1 N/O contact, input voltage 24 V AC/DC

Relay base - PLC-BSP- 24UC/ 1/ACT - 2982809



6.2 mm PLC basic terminal block for output functions with spring-cage connection, without relay or solid-state relay, for mounting on DIN rail NS 35/7,5, with load return line connection (BB), 1 N/O contact, input voltage 24 V AC/DC

Relay base - PLC-BSC- 24UC/ 1/ACT - 2982799



6.2 mm PLC basic terminal block for output functions with screw connection, without relay or solid-state relay, for mounting on DIN rail NS 35/7,5, with load return line connection (BB), 1 N/O contact, input voltage 24 V AC/DC

Single relay - REL-MR- 24DC/21AU - 2961121

Accessories

Relay base - PLC-BSC- 24DC/21/SO46 - 2980458



6.2 mm PLC basic terminal block with protection against interference currents and interference voltages on the control side, with screw connection, without relay or solid-state relay, for mounting on NS 35/7,5 DIN rail, with increased input current consumption, 1 PDT, 24 V DC input voltage

Relay base - RIF-0-BPT/21 - 2900958



RIF-0... relay base, for miniature power relay with 1 PDT or solid-state relays of the same design, push-in connection, for mounting on NS 35/7,5

Relay base - RIF-0-BSC/21 - 2900957



RIF-0... relay base, for miniature power relay with 1 changeover contact or identical solid-state relays, screw connection, for mounting on NS 35/7,5

Phoenix Contact 2020 © - all rights reserved
<http://www.phoenixcontact.com>

PHOENIX CONTACT GmbH & Co. KG
Flachsmarktstr. 8
32825 Blomberg
Germany
Tel. +49 5235 300
Fax +49 5235 3 41200
<http://www.phoenixcontact.com>

X-ON Electronics

Largest Supplier of Electrical and Electronic Components

Click to view similar products for [General Purpose Relays](#) category:

Click to view products by [Phoenix Contact](#) manufacturer:

Other Similar products are found below :

[PCN-105D3MH,000](#) [59641F200](#) [LY1SAC110120](#) [5X827E](#) [5X837F](#) [5X840F](#) [5X842F](#) [5X848E](#) [LY2N-AC120](#) [LY2S-AC220/240](#) [LY2-US-AC120](#) [LY3-US-AC120](#) [LY4F-UA-DC12](#) [LY4F-UA-DC24](#) [LY4F-US-AC120](#) [LY4F-US-AC240](#) [LY4F-US-DC24](#) [LY4F-VD-AC110](#) [LYQ20DC12](#) [M115C60](#) [M115N010](#) [M115N0150](#) [6031007G](#) [603-12D](#) [61211T0B4](#) [61212T400](#) [61222Q400](#) [61243B600](#) [61243C500](#) [61243Q400](#) [61311BOA2](#) [61311BOA6](#) [61311BOA8](#) [61311C0A2](#) [61311COA1](#) [61311COA6](#) [61311F0A2](#) [61311QOA1](#) [61311QOA4](#) [61311T0D6](#) [61311TOA6](#) [61311TOA7](#) [61311TOB3](#) [61311TOB4](#) [61311U0A6](#) [61312Q600](#) [61312T400](#) [61312T600](#) [61313U200](#) [61313U400](#)