

Safety relays - PSR-SCP- 24UC/THC4/2X1/1X2 - 2963721

Please be informed that the data shown in this PDF Document is generated from our Online Catalog. Please find the complete data in the user's documentation. Our General Terms of Use for Downloads are valid (<http://phoenixcontact.com/download>)



Safety relay for two-hand control devices in accordance with ISO 13851 type IIIC to SIL 3 or Cat. 4, PL e in accordance with EN ISO 13849, synchronous activation monitoring < 0.5 s, 2 N/O contacts, 1 N/C contact, safe isolation, width: 22.5 mm, pluggable screw terminal block

Your advantages

- For two-hand control devices according to EN 574 Type IIIC
- Up to Cat. 4/PL e according to ISO 13849-1, SILCL 3 according to IEC 62061, SIL 3 according to IEC 61508
- Two-channel control
- Synchronous activation monitoring < 0.5 s
- Automatic activation
- Two enabling and one signaling current path



Key Commercial Data

Packing unit	1 pc
GTIN	 4 017918 818692
GTIN	4017918818692

Technical data

Note

Utilization restriction	EMC: class A product, see manufacturer's declaration in the download area
-------------------------	---

Dimensions

Width	22.5 mm
Height	99 mm
Depth	114.5 mm

Ambient conditions

Ambient temperature (operation)	-20 °C ... 55 °C
Ambient temperature (storage/transport)	-40 °C ... 70 °C
Max. permissible relative humidity (operation)	75 % (on average, 85% infrequently, non-condensing)

Safety relays - PSR-SCP- 24UC/THC4/2X1/1X2 - 2963721

Technical data

Ambient conditions

Max. permissible humidity (storage/transport)	75 % (on average, 85% infrequently, non-condensing)
Maximum altitude	max. 2000 m (Above sea level)

Input data

Nominal input voltage U_N	24 V AC/DC
Input voltage range	20.4 V AC/DC ... 26.4 V AC/DC
Input voltage range in reference to U_N	0.85 ... 1.1
Typical input current at U_N	125 mA AC
	60 mA DC
Voltage at input/start and feedback circuit	approx. 24 V DC
Typical response time	50 ms
Typical release time	20 ms
Concurrence input 1/2	< 0.5 s
Recovery time	1 s
Operating voltage display	Green LED
Status display	Green LED
Protective circuit	Fuse PTC resistor
	Surge protection Suppressor diode

Output data

Contact type	2 enabling current paths
	1 signaling current path
Contact material	AgSnO ₂ , + 0.2 μm Au
Maximum switching voltage	250 V AC/DC
Minimum switching voltage	15 V AC/DC
Limiting continuous current	6 A (N/O contact)
	5 A (N/C contact)
Maximum inrush current	6 A
Inrush current, minimum	25 mA
Interrupting rating (ohmic load) max.	144 W (24 V DC, τ = 0 ms)
	288 W (48 V DC, τ = 0 ms)
	110 W (110 V DC, τ = 0 ms)
	88 W (220 V DC, τ = 0 ms)
	1500 VA (250 V AC, τ = 0 ms)
Maximum interrupting rating (inductive load)	42 W (24 V DC, τ = 40 ms)
	42 W (48 V DC, τ = 40 ms)
	42 W (110 V DC, τ = 40 ms)
	42 W (220 V DC, τ = 40 ms)
Switching capacity min.	0.4 W
Mechanical service life	approx. 10 ⁷ cycles
Switching capacity (360/h cycles)	4 A (24 V DC)

Safety relays - PSR-SCP- 24UC/THC4/2X1/1X2 - 2963721

Technical data

Output data

	4 A (230 V AC)
Output fuse	10 A gL/gG NEOZED (N/O contact)
	6 A gL/gG NEOZED (N/C contact)

General

Relay type	Electromechanical relay with force-guided contacts in accordance with IEC/EN 61810-3
Nominal operating mode	100% operating factor
Net weight	193.3 g
Mounting position	any
Mounting type	DIN rail mounting
Degree of protection	IP20
Min. degree of protection of inst. location	IP54
Housing color	yellow

Connection data

Connection method	Screw connection
pluggable	Yes
Conductor cross section solid	0.2 mm ² ... 2.5 mm ²
Conductor cross section flexible	0.2 mm ² ... 2.5 mm ²
Conductor cross-section AWG	24 ... 12
Stripping length	7 mm
Screw thread	M3

Safety-related characteristic data

Stop category	0
Type class	IIIC
Designation	IEC 61508 - High demand
Safety Integrity Level (SIL)	3
Designation	IEC 61508 - Low demand
Safety Integrity Level (SIL)	3
Designation	EN ISO 13849
Performance level (PL)	e
Category	4
Designation	EN 62061
Safety Integrity Level Claim Limit (SIL CL)	3

Standards and Regulations

Designation	Air clearances and creepage distances between the power circuits
Standards/regulations	DIN EN 50178/VDE 0160
Rated insulation voltage	250 V
Rated surge voltage/insulation	6 kV / Safe isolation, increased insulation
Degree of pollution	2

Safety relays - PSR-SCP- 24UC/THC4/2X1/1X2 - 2963721

Technical data

Standards and Regulations

Overvoltage category	III
Shock	15g
Vibration (operation)	10 Hz ... 150 Hz, 2g

Environmental Product Compliance

REACH SVHC	Lead 7439-92-1
China RoHS	Environmentally Friendly Use Period = 50 years
	For details about hazardous substances go to tab "Downloads", Category "Manufacturer's declaration"

Drawings

Circuit diagram

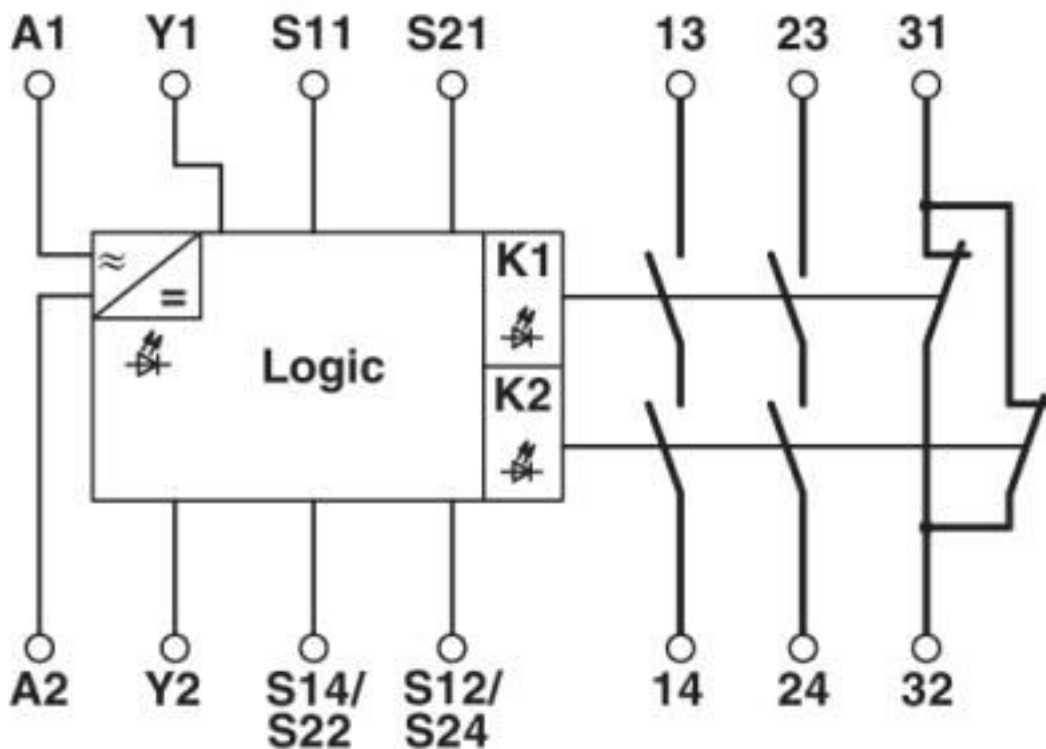

Safety relays - PSR-SCP- 24UC/THC4/2X1/1X2 - 2963721

Circuit diagram

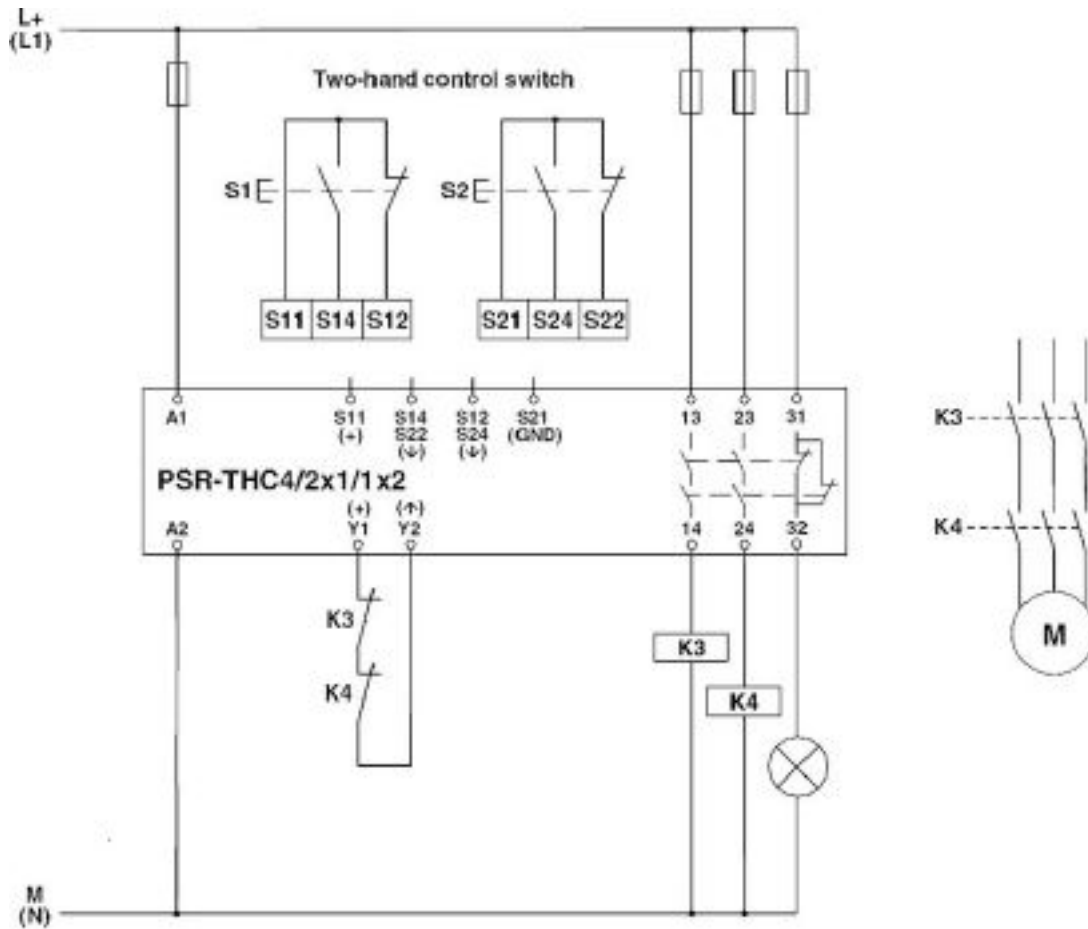

Two-hand control device

Classifications

eCl@ss

eCl@ss 10.0.1	27371821
eCl@ss 4.0	40020600
eCl@ss 4.1	40020600
eCl@ss 5.0	27371900
eCl@ss 5.1	27371900
eCl@ss 6.0	27371800
eCl@ss 7.0	27371821
eCl@ss 8.0	27371821
eCl@ss 9.0	27371821

ETIM

ETIM 2.0	EC000196
ETIM 3.0	EC001449

Safety relays - PSR-SCP- 24UC/THC4/2X1/1X2 - 2963721

Classifications

ETIM

ETIM 4.0	EC001449
ETIM 5.0	EC001452
ETIM 6.0	EC001452
ETIM 7.0	EC001452

UNSPSC

UNSPSC 6.01	30211901
UNSPSC 7.0901	39121501
UNSPSC 11	39121501
UNSPSC 12.01	39121501
UNSPSC 13.2	39121105
UNSPSC 18.0	39121105
UNSPSC 19.0	39121105
UNSPSC 20.0	39121105
UNSPSC 21.0	39121105

Approvals

Approvals

Approvals

Functional Safety / UL Listed / cUL Listed / Functional Safety / EAC / EAC / cULus Listed

Ex Approvals

Approval details





Functional Safety		968/EZ 346.02/20
-------------------	--	------------------

UL Listed		http://database.ul.com/cgi-bin/XYV/template/LISEXT/1FRAME/index.htm	FILE E 140324
-----------	--	---	---------------

cUL Listed		http://database.ul.com/cgi-bin/XYV/template/LISEXT/1FRAME/index.htm	FILE E 140324
------------	--	---	---------------

Safety relays - PSR-SCP- 24UC/THC4/2X1/1X2 - 2963721

Approvals

Functional Safety		01/205/0542.02/20
EAC		EAC-Zulassung
EAC		RU C- DE.A*30.B.01082
cULus Listed		

Phoenix Contact 2020 © - all rights reserved
<http://www.phoenixcontact.com>

PHOENIX CONTACT GmbH & Co. KG
Flachmarktstr. 8
32825 Blomberg
Germany
Tel. +49 5235 300
Fax +49 5235 3 41200
<http://www.phoenixcontact.com>

X-ON Electronics

Largest Supplier of Electrical and Electronic Components

Click to view similar products for [Safety Relays](#) category:

Click to view products by [Phoenix Contact](#) manufacturer:

Other Similar products are found below :

[7-1618103-5](#) [1351-1X](#) [1618082-4](#) [1618111-1](#) [C200HDA003](#) [C200HMR432](#) [C200HMR832](#) [C200HMR833](#) [C28PEDRA](#) [20-050-36X](#)
[C500ETL01](#) [C500OD415CN](#) [2-1618068-0](#) [9-1618103-2](#) [SP10-ETL01](#) [C200HNC112](#) [C200HOD214](#) [C500CN812N](#) [4NK0AQY](#) [1100-42X](#)
[V23050A1012A551](#) [6-1618082-4](#) [7-1618103-6](#) [WTD-101X](#) [SP16DRD](#) [SP16DRA](#) [C500-CE243](#) [C500-IDS02-V1](#) [607.5111.020](#) [DOLD](#)
[48173](#) [CS AR-02V024](#) [CS AR-20V024](#) [CS AR-22V024](#) [CS AR-22V230](#) [750136](#) [777512](#) [PSR-MS21-1NO-1DO-24DC-SC](#) [600PSR-](#)
[165/300-CU](#) [SR6V6K18](#) [SR4M4005](#) [BPS 36-1](#) [BP34 - 101057553](#) [2TLA010033R3000](#) [2TLA010033R0000](#) [2TLA010028R1000](#)
[2TLA010017R0100](#) [2TLA010026R0400](#) [2TLA020007R6900](#) [SCR 2-W22-2.5](#) [7S.34.9.110.4220](#)