

Plug - SPDB 2,5/ 1-L BU - 3043200

Please be informed that the data shown in this PDF Document is generated from our Online Catalog. Please find the complete data in the user's documentation. Our General Terms of Use for Downloads are valid (<http://phoenixcontact.com/download>)



Plug, number of positions: 1, connection method: Spring-cage connection, cross section: 0.08 mm²- 4 mm², AWG: 28 - 12, nominal current: 24 A, nom. voltage: 500 V, width: 5.2 mm, color: blue

Product Description

Connector element left, left housing without engagement pin, right opened without cover

Your advantages

- Plug with bridging option, for use with basic terminal blocks
- The plug with spring-cage connection is assembled directly on site by snapping together single-position plug elements
- The ST-COMBI plugs for self-assembly provide solutions that users can implement themselves
- Tested for railway applications



COMPLETE RoHS

Key Commercial Data

Packing unit	50 pc
Minimum order quantity	50 pc
GTIN	 4 017918 895068
GTIN	4017918895068

Technical data

General

Number of positions	1
Nominal cross section	2.5 mm ²
Color	blue
Insulating material	PA
Flammability rating according to UL 94	V0
Rated surge voltage	6 kV
Degree of pollution	3
Overvoltage category	III
Insulating material group	I

Plug - SPDB 2,5/ 1-L BU - 3043200

Technical data

General

Maximum power dissipation for nominal condition	0.77 W
Maximum load current	24 A (with 4 mm ² conductor cross section)
Nominal current I _N	24 A
Nominal voltage U _N	500 V
Relative insulation material temperature index (Elec., UL 746 B)	130 °C
Temperature index of insulation material (DIN EN 60216-1 (VDE 0304-21))	130 °C
Static insulating material application in cold	-60 °C
Surface flammability NFPA 130 (ASTM E 162)	passed
Specific optical density of smoke NFPA 130 (ASTM E 662)	passed
Calorimetric heat release NFPA 130 (ASTM E 1354)	28 MJ/kg
Smoke gas toxicity NFPA 130 (SMP 800C)	passed
Fire protection for rail vehicles (DIN EN 45545-2) R22	HL 1 - HL 3
Fire protection for rail vehicles (DIN EN 45545-2) R23	HL 1 - HL 3
Fire protection for rail vehicles (DIN EN 45545-2) R24	HL 1 - HL 3
Fire protection for rail vehicles (DIN EN 45545-2) R26	HL 1 - HL 3

Dimensions

Width	5.2 mm
Length	32.7 mm
Height	39 mm
	24 mm
Pitch	5.2 mm

Connection data

Connection method	Spring-cage connection
Stripping length	8 mm ... 10 mm
Connection in acc. with standard	IEC 61984
Conductor cross section solid min.	0.08 mm ²
Conductor cross section solid max.	4 mm ²
Conductor cross section AWG min.	28
Conductor cross section AWG max.	12
Conductor cross section flexible min.	0.08 mm ²
Conductor cross section flexible max.	2.5 mm ²
Min. AWG conductor cross section, flexible	28
Max. AWG conductor cross section, flexible	14
Conductor cross section flexible, with ferrule without plastic sleeve min.	0.14 mm ²
Conductor cross section flexible, with ferrule without plastic sleeve max.	2.5 mm ²
Conductor cross section flexible, with ferrule with plastic sleeve min.	0.14 mm ²
Conductor cross section flexible, with ferrule with plastic sleeve max.	2.5 mm ²
Two conductors with the same cross section, flexible, with TWIN ferrules, with plastic sleeve, maximum	0.5 mm ²

Plug - SPDB 2,5/ 1-L BU - 3043200

Technical data

Connection data

Internal cylindrical gage	A3
---------------------------	----

Standards and Regulations

Connection in acc. with standard	CSA
	IEC 61984
Flammability rating according to UL 94	V0

Environmental Product Compliance

China RoHS	Environmentally friendly use period: unlimited = EFUP-e
	No hazardous substances above threshold values

Drawings

Schematic diagram

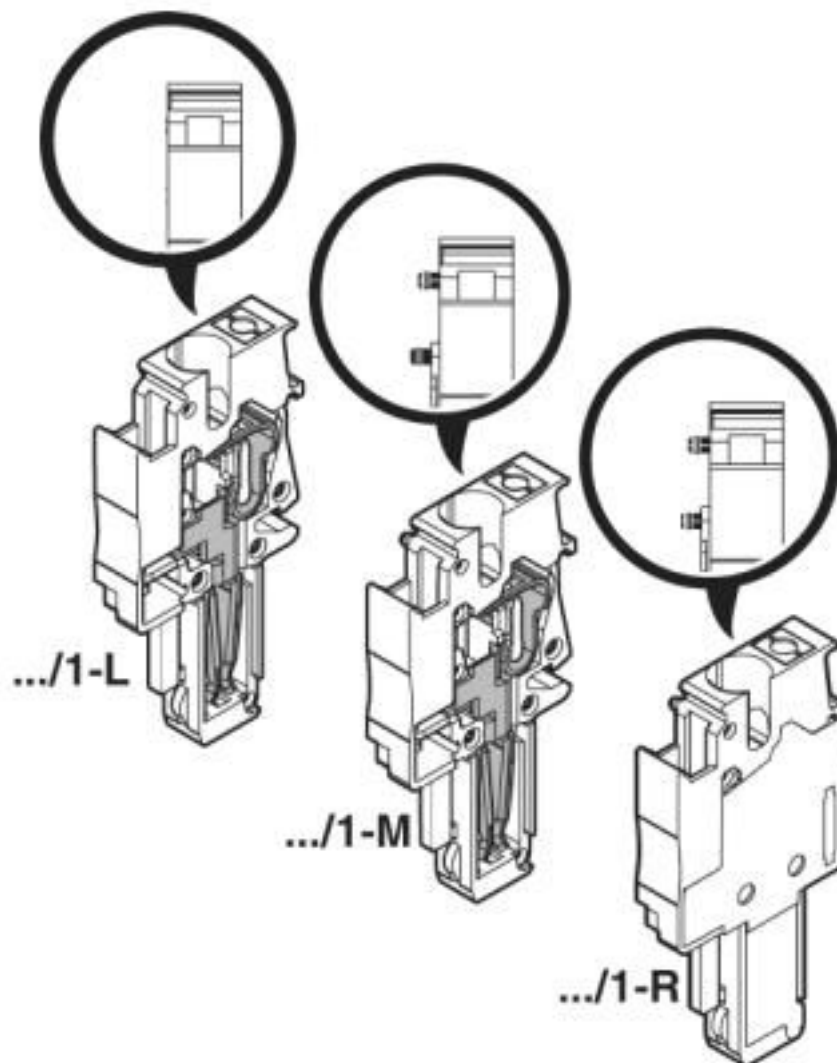

Plug - SPDB 2,5/ 1-L BU - 3043200

Diagram

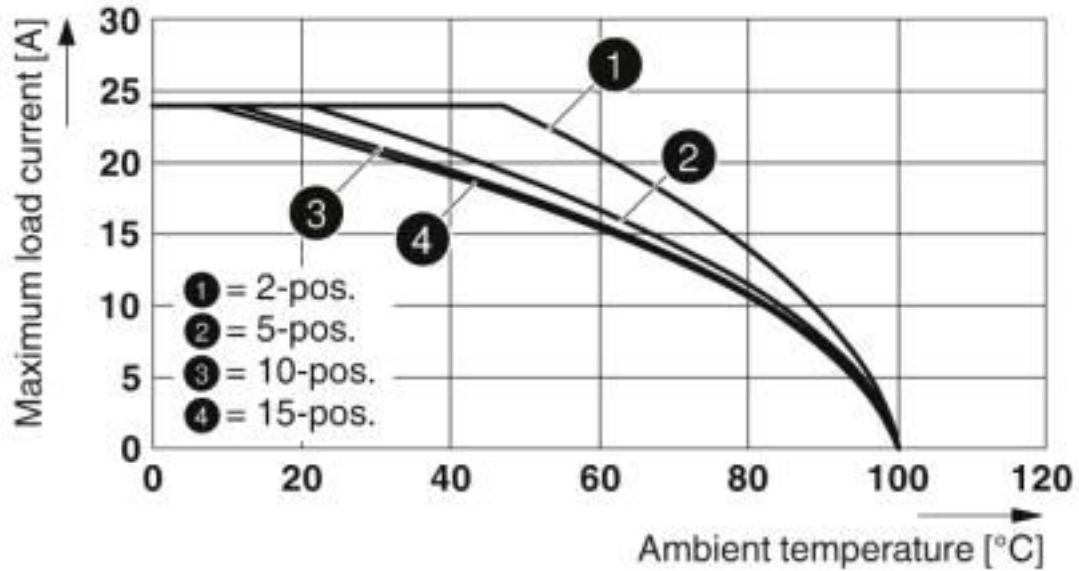

Derating curve for ST 2,5/ 1P, ST 2,5/ 2P, ST 2,5-TWIN/ 1P and for all plug versions SP...

Diagram

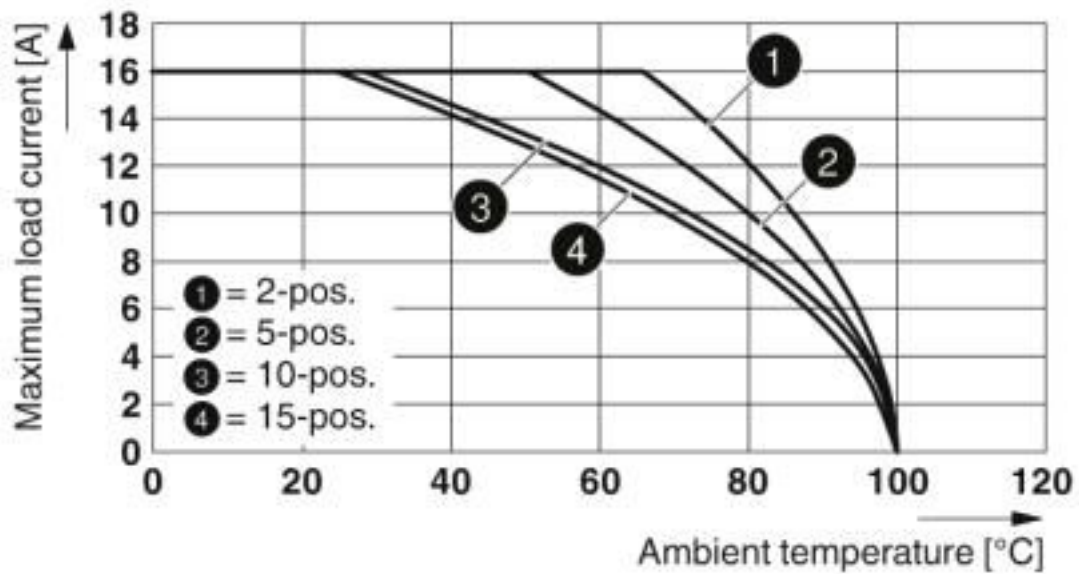

Derating curve for ST 2,5-TWIN-MT/1P, ST 2,5-TWIN-TG/1P and for all plug versions SP...

Plug - SPDB 2,5/ 1-L BU - 3043200

Diagram

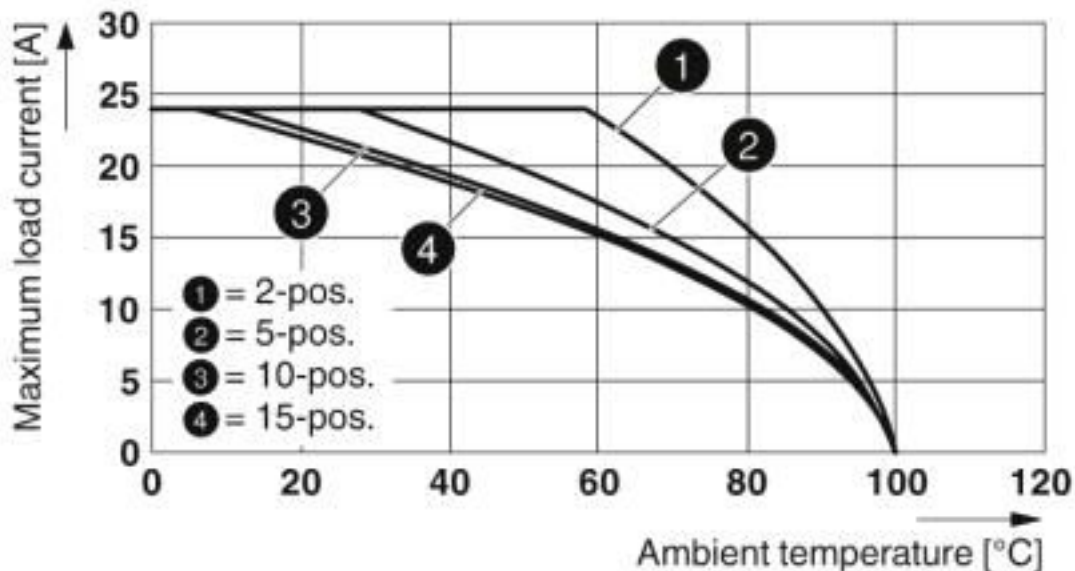

Derating curve for ST 2,5-QUATTRO/2P, ST 2,5-QUATTRO/4P and for all plug versions SP...

Diagram

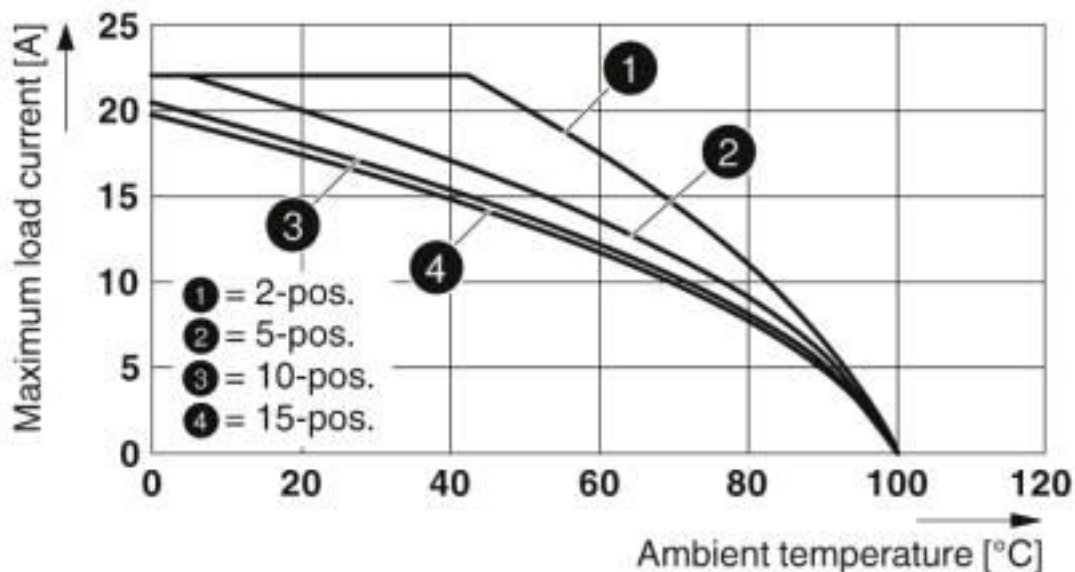

Derating curve for STTB 2,5/ 2P, STTB 2,5/ 2P-PV and for all plug versions SP...

Plug - SPDB 2,5/ 1-L BU - 3043200

Diagram

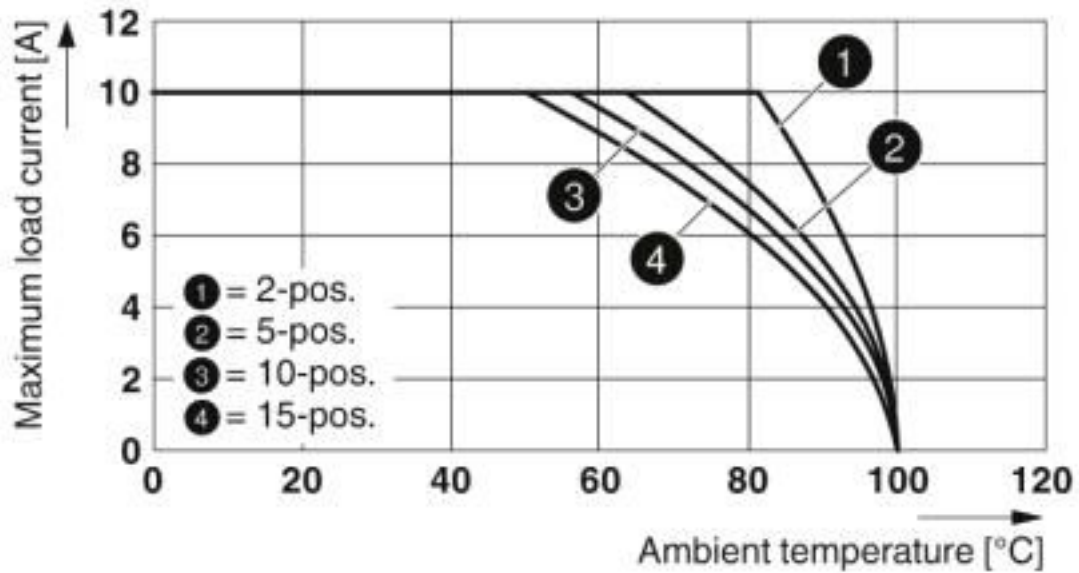

Derating curve for ST 2,5-4L/1P, ST 2,5-4L/2P and for all plug versions SP...

Circuit diagram



Classifications

eCl@ss

eCl@ss 10.0.1	27141151
eCl@ss 4.0	27260700
eCl@ss 4.1	27260700
eCl@ss 5.0	27260700
eCl@ss 5.1	27260700
eCl@ss 6.0	27141100
eCl@ss 7.0	27141151
eCl@ss 8.0	27141151
eCl@ss 9.0	27141151

ETIM

ETIM 2.0	EC000897
ETIM 3.0	EC000897
ETIM 4.0	EC002021
ETIM 5.0	EC002021
ETIM 6.0	EC002021

Plug - SPDB 2,5/ 1-L BU - 3043200

Classifications

ETIM

ETIM 7.0	EC002021
----------	----------

UNSPSC

UNSPSC 6.01	30211802
UNSPSC 7.0901	39121402
UNSPSC 11	39121402
UNSPSC 12.01	39121402
UNSPSC 13.2	39121402
UNSPSC 18.0	39121402
UNSPSC 19.0	39121402
UNSPSC 20.0	39121402
UNSPSC 21.0	39121402

Approvals

Approvals

Approvals

DNV GL / CSA / BV / LR / UL Recognized / cUL Recognized / IECCEB Scheme / EAC / EAC / VDE Zeichengenehmigung / RS / cULus Recognized

Ex Approvals

Approval details

DNV GL		https://approvalfinder.dnvgl.com/	TAE00001CS
--------	--	---	------------

CSA		http://www.csagroup.org/services-industries/product-listing/	13631
	B	C	D
Nominal voltage UN	300 V	300 V	600 V
Nominal current IN	20 A	20 A	5 A
mm ² /AWG/kcmil	24-12	24-12	24-12

BV		http://www.veristar.com/portal/veristarinfo/generalinfo/approved/approvedProducts/equipmentAndMaterials	27721/B0 BV
----	--	---	-------------

Plug - SPDB 2,5/ 1-L BU - 3043200

Approvals

LR		http://www.lr.org/en	05/20042
----	--	---	----------

UL Recognized		http://database.ul.com/cgi-bin/XYV/template/LISEXT/1FRAME/index.htm	FILE E 60425
	B	C	D
Nominal voltage UN	300 V	300 V	600 V
Nominal current IN	20 A	20 A	5 A
mm ² /AWG/kcmil	26-12	26-12	26-12

cUL Recognized		http://database.ul.com/cgi-bin/XYV/template/LISEXT/1FRAME/index.htm	FILE E 60425
	B	C	D
Nominal voltage UN	300 V	300 V	600 V
Nominal current IN	20 A	20 A	5 A
mm ² /AWG/kcmil	26-12	26-12	26-12

IECEE CB Scheme		http://www.iecee.org/	DE1-62736/B1/B2
-----------------	--	---	-----------------

EAC			RU C- DE.A*30.B.01742
-----	--	--	--------------------------

EAC			RU C- DE.BL08.B.00511
-----	--	--	--------------------------

VDE Zeichengenehmigung		http://www2.vde.com/de/Institut/Online-Service/VDE-gepruefteProdukte/Seiten/Online-Suche.aspx	40019518
Nominal voltage UN		500 V	
mm ² /AWG/kcmil		0.2-4	

RS		http://www.rs-head.spb.ru/en/index.php	17.00013.272
----	--	---	--------------

Plug - SPDB 2,5/ 1-L BU - 3043200

Approvals

cULus Recognized



Accessories

Accessories

Bridge

Wire bridge - FBSW 2-5/250MM - 3030172



Wire bridge, length: 250 mm, width: 5.1 mm, number of positions: 1, color: red/black

Wire bridge - FBSW 2-5/60MM - 3030170



Wire bridge, length: 60 mm, width: 5.1 mm, number of positions: 1, color: red/black

Wire bridge - FBSW 2-5/110MM - 3030171



Wire bridge, length: 110 mm, width: 5.1 mm, number of positions: 1, color: red/black

Flange

Flange cover - DFS-SPDB 2,5 - 3061457



Flange cover, length: 35.8 mm, width: 4.5 mm, height: 24.7 mm, color: gray

Insulating sleeve

Plug - SPDB 2,5/ 1-L BU - 3043200

Accessories

Insulating sleeve - ISH 2,5/0,2 - 3002843



Insulating sleeve, color: white

Insulating sleeve - ISH 2,5/0,5 - 3002856



Insulating sleeve, color: gray

Insulating sleeve - ISH 2,5/1,0 - 3002869



Insulating sleeve, color: black

Jumper

Plug-in bridge - FBS 2-5 - 3030161



Plug-in bridge, pitch: 5.2 mm, length: 22.7 mm, width: 9 mm, number of positions: 2, color: red

Plug-in bridge - FBS 3-5 - 3030174



Plug-in bridge, pitch: 5.2 mm, length: 22.7 mm, width: 14.2 mm, number of positions: 3, color: red

Plug - SPDB 2,5/ 1-L BU - 3043200

Accessories

Plug-in bridge - FBS 4-5 - 3030187



Plug-in bridge, pitch: 5.2 mm, length: 22.7 mm, width: 19.4 mm, number of positions: 4, color: red

Plug-in bridge - FBS 5-5 - 3030190



Plug-in bridge, pitch: 5.2 mm, length: 23 mm, width: 24.6 mm, number of positions: 5, color: red

Plug-in bridge - FBS 10-5 - 3030213



Plug-in bridge, pitch: 5.2 mm, length: 22.7 mm, width: 50.6 mm, number of positions: 10, color: red

Plug-in bridge - FBS 20-5 - 3030226



Plug-in bridge, pitch: 5.2 mm, number of positions: 20, color: red

Plug-in bridge - FBS 50-5 - 3038930



Plug-in bridge, pitch: 5.2 mm, number of positions: 50, color: red

Plug - SPDB 2,5/ 1-L BU - 3043200

Accessories

Plug-in bridge - FBS 2-5 BU - 3036877



Plug-in bridge, pitch: 5.2 mm, number of positions: 2, color: blue

Plug-in bridge - FBS 3-5 BU - 3036880



Plug-in bridge, pitch: 5.2 mm, number of positions: 3, color: blue

Plug-in bridge - FBS 4-5 BU - 3036893



Plug-in bridge, pitch: 5.2 mm, number of positions: 4, color: blue

Plug-in bridge - FBS 5-5 BU - 3036903



Plug-in bridge, pitch: 5.2 mm, number of positions: 5, color: blue

Plug-in bridge - FBS 10-5 BU - 3036916



Plug-in bridge, pitch: 5.2 mm, number of positions: 10, color: blue

Plug - SPDB 2,5/ 1-L BU - 3043200

Accessories

Plug-in bridge - FBS 20-5 BU - 3036929



Plug-in bridge, pitch: 5.2 mm, number of positions: 20, color: blue

Plug-in bridge - FBS 50-5 BU - 3032114



Plug-in bridge, pitch: 5.2 mm, number of positions: 50, color: blue

Plug-in bridge - FBS 2-5 GY - 3038969



Plug-in bridge, pitch: 5.2 mm, number of positions: 2, color: gray

Plug-in bridge - FBS 3-5 GY - 3038972



Plug-in bridge, pitch: 5.2 mm, number of positions: 3, color: gray

Plug-in bridge - FBS 4-5 GY - 3038985



Plug-in bridge, pitch: 5.2 mm, number of positions: 4, color: gray

Plug - SPDB 2,5/ 1-L BU - 3043200

Accessories

Plug-in bridge - FBS 5-5 GY - 3038998



Plug-in bridge, pitch: 5.2 mm, number of positions: 5, color: gray

Plug-in bridge - FBS 10-5 GY - 3039007



Plug-in bridge, pitch: 5.2 mm, number of positions: 10, color: gray

Plug-in bridge - FBS 20-5 GY - 3038671



Plug-in bridge, pitch: 5.2 mm, number of positions: 20, color: gray

Plug-in bridge - FBS 50-5 GY - 3032127



Plug-in bridge, pitch: 5.2 mm, number of positions: 50, color: gray

Plug-in bridge - FBSR 2-5 - 3033702



Plug-in bridge, pitch: 5.2 mm, number of positions: 2, color: red

Plug - SPDB 2,5/ 1-L BU - 3043200

Accessories

Plug-in bridge - FBSR 3-5 - 3001591



Plug-in bridge, pitch: 5.2 mm, number of positions: 3, color: red

Plug-in bridge - FBSR 4-5 - 3001592



Plug-in bridge, pitch: 5.2 mm, number of positions: 4, color: red

Plug-in bridge - FBSR 5-5 - 3001593



Plug-in bridge, pitch: 5.2 mm, number of positions: 5, color: red

Plug-in bridge - FBSR 10-5 - 3033710



Plug-in bridge, pitch: 5.2 mm, number of positions: 10, color: red

Labeled terminal marker

Zack Marker strip, flat - ZBF 5 CUS - 0825025



Zack Marker strip, flat, can be ordered: Strip, white, labeled according to customer specifications, mounting type: snap into flat marker groove, for terminal block width: 5 mm, lettering field size: 5.15 x 5.15 mm, Number of individual labels: 10

Plug - SPDB 2,5/ 1-L BU - 3043200

Accessories

Zack Marker strip, flat - ZBF 5,LGS:FORTL.ZAHLEN - 0808671



Zack Marker strip, flat, Strip, white, labeled, printed horizontally: consecutive numbers 1 ... 10, 11 ... 20, etc. up to 491 ... 500, mounting type: snap into flat marker groove, for terminal block width: 5 mm, lettering field size: 5.15 x 5.15 mm, Number of individual labels: 10

Zack Marker strip, flat - ZBF 5,QR:FORTL.ZAHLEN - 0808697



Zack Marker strip, flat, Strip, white, labeled, Printed vertically: consecutive numbers 1 ... 10, 11 ... 20, etc. up to 91 ... 100, mounting type: snap into flat marker groove, for terminal block width: 5 mm, lettering field size: 5.15 x 5.15 mm, Number of individual labels: 10

Zack Marker strip, flat - ZBF 5,LGS:GERADE ZAHLEN - 0810821



Zack Marker strip, flat, Strip, white, labeled, printed horizontally: consecutive numbers 2 ... 20, 22 ... 40, etc. up to 82 ... 100, mounting type: snap into flat marker groove, for terminal block width: 5 mm, lettering field size: 5.15 x 5.15 mm, Number of individual labels: 10

Zack Marker strip, flat - ZBF 5,LGS:UNGERADE ZAHLEN - 0810863



Zack Marker strip, flat, Strip, white, labeled, printed horizontally: Odd numbers 1 - 19, 21 - 39, etc. up to 81 - 99, mounting type: snap into flat marker groove, for terminal block width: 5 mm, lettering field size: 5.15 x 5.15 mm, Number of individual labels: 10

Marker for terminal blocks - UC-TMF 5 CUS - 0824638



Marker for terminal blocks, can be ordered: by sheet, white, labeled according to customer specifications, mounting type: snap into flat marker groove, for terminal block width: 5.2 mm, lettering field size: 4.6 x 5.1 mm, Number of individual labels: 96

Plug - SPDB 2,5/ 1-L BU - 3043200

Accessories

Marker for terminal blocks - UCT-TMF 5 CUS - 0829658



Marker for terminal blocks, can be ordered: by sheet, white, labeled according to customer specifications, mounting type: snap into flat marker groove, for terminal block width: 5.2 mm, lettering field size: 4.4 x 4.7 mm, Number of individual labels: 72

Marker pen

Marker pen - B-STIFT - 1051993



Marker pen, for manual labeling of unprinted Zack strips, smear-proof and waterproof, line thickness 0.5 mm

Marker pen - X-PEN 0,35 - 0811228



Marker pen without ink cartridge, for manual labeling of markers, labeling extremely wipe-proof, line thickness 0.35 mm

Mounting material

Strain relief - PDZ/2 - 3040562



Strain relief, length: 28.9 mm, width: 9.6 mm, number of positions: 2, color: black

Strain relief - PDZ/4 - 3040575



Strain relief, length: 28.9 mm, width: 19.8 mm, number of positions: 4, color: black

Plug - SPDB 2,5/ 1-L BU - 3043200

Accessories

Latching - PR - 3040559



Latching, length: 29.8 mm, width: 4.4 mm, number of positions: 1, color: orange

Latching - PR/2 - 3040630



Latching, length: 29.8 mm, width: 10 mm, number of positions: 2, color: orange

Latching - PRT/2 - 3040631



Latching, can only be released using a screwdriver, length: 23.2 mm, width: 9 mm, number of positions: 2, color: orange

Latching - PRZ - 3040614



Latching, length: 63.6 mm, width: 9.7 mm, number of positions: 2, color: orange

Screwdriver tools

Actuation tool - ST-BW - 1207608



Actuation tool, for all 2.5 mm² - 4.0 mm² spring-cages

Shield connection

Plug - SPDB 2,5/ 1-L BU - 3043200

Accessories

Shield connection clamp - PSH 3- 6 - 3040591



Shield connection clamp, color: black

Shield connection clamp - PSH 5-10 - 3040601



Shield connection clamp, color: black

Terminal marking

Zack Marker strip, flat - ZBF 5:UNBEDRUCKT - 0808642



Zack Marker strip, flat, Strip, white, unlabeled, can be labeled with: PLOTMARK, CMS-P1-PLOTTER, mounting type: snap into flat marker groove, for terminal block width: 5 mm, lettering field size: 5.1 x 5.2 mm, Number of individual labels: 10

Marker for terminal blocks - UC-TMF 5 - 0818153



Marker for terminal blocks, Sheet, white, unlabeled, can be labeled with: BLUEMARK ID COLOR, BLUEMARK ID, BLUEMARK CLED, PLOTMARK, CMS-P1-PLOTTER, mounting type: snap into flat marker groove, for terminal block width: 5.2 mm, lettering field size: 4.6 x 5.1 mm, Number of individual labels: 96

Marker for terminal blocks - UCT-TMF 5 - 0828744



Marker for terminal blocks, Sheet, white, unlabeled, can be labeled with: TOPMARK NEO, TOPMARK LASER, BLUEMARK ID COLOR, BLUEMARK ID, BLUEMARK CLED, THERMOMARK PRIME, THERMOMARK CARD 2.0, THERMOMARK CARD, mounting type: snap into flat marker groove, for terminal block width: 5.2 mm, lettering field size: 4.4 x 4.7 mm, Number of individual labels: 72

Phoenix Contact 2020 © - all rights reserved
<http://www.phoenixcontact.com>

PHOENIX CONTACT GmbH & Co. KG
Flachsmarktstr. 8
32825 Blomberg
Germany
Tel. +49 5235 300
Fax +49 5235 3 41200
<http://www.phoenixcontact.com>

X-ON Electronics

Largest Supplier of Electrical and Electronic Components

Click to view similar products for [DIN Rail Terminal Blocks](#) category:

Click to view products by [Phoenix Contact](#) manufacturer:

Other Similar products are found below :

[00110420202](#) [8WA1011-1BH23](#) [8WA1011-1EF20](#) [91.010](#) [9102100000](#) [91.040](#) [9123140000](#) [9123140001](#) [RBO 5-T-B-HEX](#) [1333564](#) [DP25-GY-ND](#) [1431306](#) [1433306](#) [90.070](#) [91.020](#) [912314](#) [260-301_NR](#) [2757571](#) [280-331](#) [280-560](#) [280-564](#) [281-611/281-542](#) [281-673/281-411](#) [281-994](#) [283-317](#) [283-607](#) [2909798](#) [264-724](#) [264-726](#) [280-530](#) [280-555](#) [280-619](#) [281-610](#) [281-622/281-417](#) [284-317](#) [284-601](#) [2907033](#) [3048496](#) [5542152](#) [35956](#) [USK 10](#) [102510](#) [1025100000](#) [5520682](#) [5607102](#) [EMH 25-ZE30](#) [591620-2](#) [UM 45-SEFE M.NUT BK](#) [1-591651-1](#) [8671050000](#)