

Panel feed-through terminal block - PT 4-WE/18 - 3044923

Please be informed that the data shown in this PDF Document is generated from our Online Catalog. Please find the complete data in the user's documentation. Our General Terms of Use for Downloads are valid (<http://phoenixcontact.com/download>)



Panel feed-through terminal block, Minimum distance to other conductive surfaces: min 5 mm, nom. voltage: 500 V, nominal current: 24 A, connection method: Push-in connection, number of connections: 36, number of positions: 18, cross section: 0.14 mm² - 4 mm², AWG: 26 - 12, width: 97.7 mm, height: 26.6 mm, color: gray, mounting type: Wall mounting

The figure shows a version of the article

Your advantages

- Easy grouping with engagement pin versions
- CLIPLINE complete accessories for easy bridging, testing, and marking
- Easy connection of the conductors, thanks to fast Push-in spring connection
- Highly flexible, thanks to alignable single terminal blocks
- Automatic compensation of the panel thickness via the snap principle integrated in the insulation housing



Key Commercial Data

Packing unit	5 pc
GTIN	
GTIN	4055626245836

Technical data

Item properties

Number of positions	18
Number of connections	36

Dimensions for the product

Length [l]	51.3 mm
Width [w]	97.7 mm
Height [h]	26.6 mm
Pitch	5.2 mm

Dimensions for mounting cutout

Plate thickness	1 mm ... 2.5 mm
-----------------	-----------------

Panel feed-through terminal block - PT 4-WE/18 - 3044923

Technical data

Packaging information

Pieces per package	5
Denomination packing units	Pcs.

General product information

Type of note	Assembly instruction:
Note	Minimum distance to other conductive surfaces: min 5 mm

Standards and Regulations

Connection in acc. with standard	IEC 60947-7-1
Flammability rating according to UL 94	V0

Environmental Product Compliance

China RoHS	Environmentally friendly use period: unlimited = EFUP-e
	No hazardous substances above threshold values

Drawings

Dimensional drawing

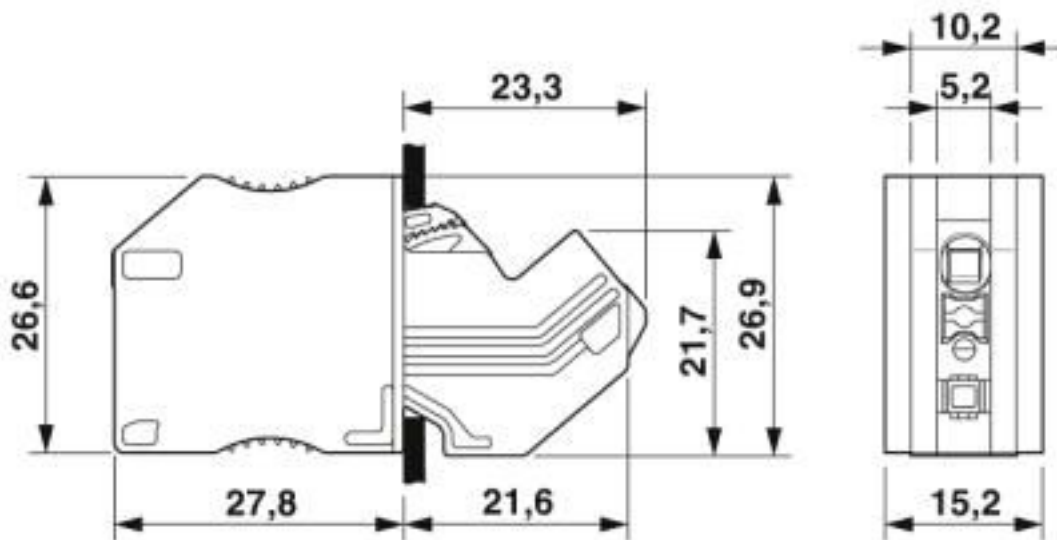

Panel feed-through terminal block - PT 4-WE/18 - 3044923

Dimensional drawing

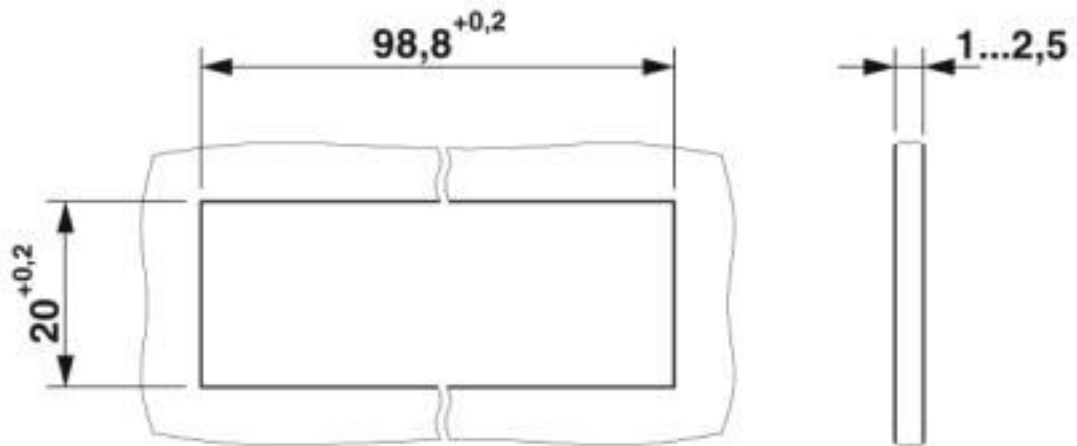

Circuit diagram



Schematic diagram

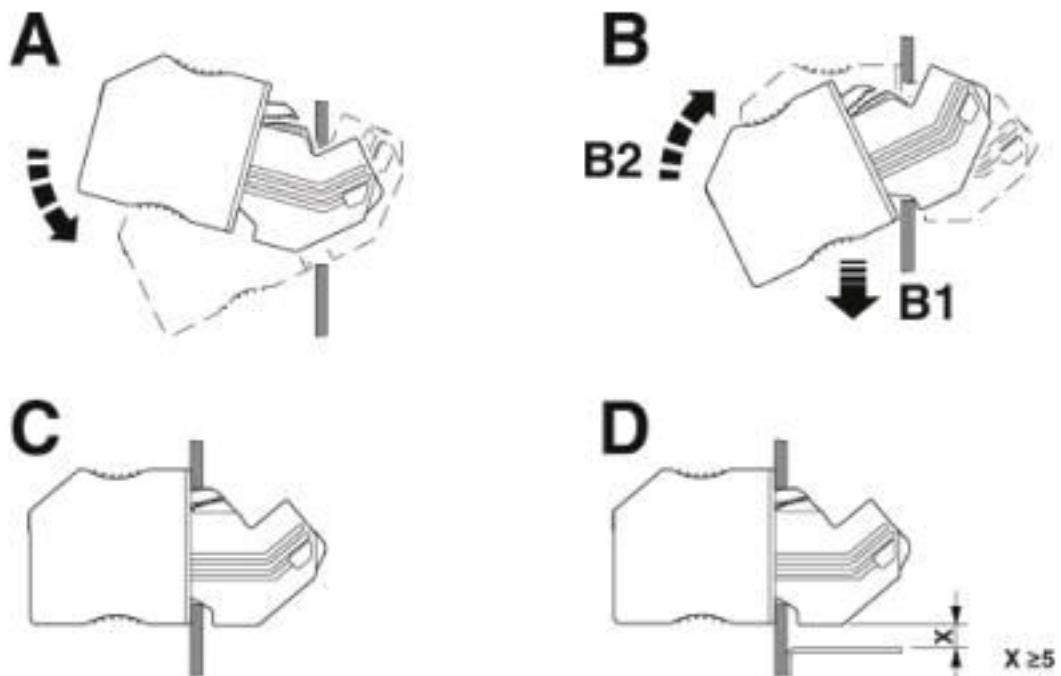

Assembly drawing

Panel feed-through terminal block - PT 4-WE/18 - 3044923

Classifications

eCl@ss

eCl@ss 10.0.1	27141120
eCl@ss 4.0	27141111
eCl@ss 4.1	27141111
eCl@ss 5.0	27141100
eCl@ss 5.1	27141100
eCl@ss 6.0	27141100
eCl@ss 7.0	27141134
eCl@ss 8.0	27141120
eCl@ss 9.0	27141120

ETIM

ETIM 3.0	EC001283
ETIM 4.0	EC001283
ETIM 5.0	EC000897
ETIM 6.0	EC000897
ETIM 7.0	EC000897

UNSPSC

UNSPSC 6.01	30211811
UNSPSC 7.0901	39121410
UNSPSC 11	39121410
UNSPSC 12.01	39121410
UNSPSC 13.2	39121410
UNSPSC 18.0	39121410
UNSPSC 19.0	39121410
UNSPSC 20.0	39121410
UNSPSC 21.0	39121410

Approvals

Approvals

Approvals

UL Recognized / cUL Recognized / EAC / EAC / EAC / EAC / cULus Recognized

Ex Approvals

Approval details

Panel feed-through terminal block - PT 4-WE/18 - 3044923

Approvals

UL Recognized		http://database.ul.com/cgi-bin/XYV/template/LISEXT/1FRAME/index.htm	FILE E 60425
---------------	-----------------------------------------------------------------------------------	-------------------------------------------------------------------------------------------------------------------------------------------------------	--------------

	B	C	D
Nominal voltage UN	300 V	150 V	300 V
Nominal current IN	25 A	25 A	10 A
mm ² /AWG/kcmil	24-10	24-10	24-10

cUL Recognized		http://database.ul.com/cgi-bin/XYV/template/LISEXT/1FRAME/index.htm	FILE E 60425
----------------	-----------------------------------------------------------------------------------	-------------------------------------------------------------------------------------------------------------------------------------------------------	--------------

	B	C	D
Nominal voltage UN	300 V	150 V	300 V
Nominal current IN	25 A	25 A	10 A
mm ² /AWG/kcmil	24-10	24-10	24-10

EAC		EAC-Zulassung
-----	-------------------------------------------------------------------------------------	---------------

EAC		RU C- DE.A*30.B.01742
-----	-------------------------------------------------------------------------------------	--------------------------

EAC		RU C- DE.AI30.B.01102
-----	-------------------------------------------------------------------------------------	--------------------------

EAC		RU C- DE.BL08.B.00682
-----	-------------------------------------------------------------------------------------	--------------------------

cULus Recognized		
------------------	-------------------------------------------------------------------------------------	--

Accessories

Accessories

End cover

Panel feed-through terminal block - PT 4-WE/18 - 3044923

Accessories

End cover - D-PT 4-WE - 3044902



End cover, Right / left, length: 49.4 mm, width: 5 mm, height: 26.9 mm, color: gray

Jumper

Plug-in bridge - FBS 2-5 - 3030161



Plug-in bridge, pitch: 5.2 mm, length: 22.7 mm, width: 9 mm, number of positions: 2, color: red

Plug-in bridge - FBS 3-5 - 3030174



Plug-in bridge, pitch: 5.2 mm, length: 22.7 mm, width: 14.2 mm, number of positions: 3, color: red

Plug-in bridge - FBS 4-5 - 3030187



Plug-in bridge, pitch: 5.2 mm, length: 22.7 mm, width: 19.4 mm, number of positions: 4, color: red

Plug-in bridge - FBS 5-5 - 3030190



Plug-in bridge, pitch: 5.2 mm, length: 23 mm, width: 24.6 mm, number of positions: 5, color: red

Panel feed-through terminal block - PT 4-WE/18 - 3044923

Accessories

Plug-in bridge - FBS 10-5 - 3030213



Plug-in bridge, pitch: 5.2 mm, length: 22.7 mm, width: 50.6 mm, number of positions: 10, color: red

Plug-in bridge - FBS 20-5 - 3030226



Plug-in bridge, pitch: 5.2 mm, number of positions: 20, color: red

Plug-in bridge - FBS 50-5 - 3038930



Plug-in bridge, pitch: 5.2 mm, number of positions: 50, color: red

Plug-in bridge - FBSR 2-5 - 3033702



Plug-in bridge, pitch: 5.2 mm, number of positions: 2, color: red

Plug-in bridge - FBSR 3-5 - 3001591



Plug-in bridge, pitch: 5.2 mm, number of positions: 3, color: red

Panel feed-through terminal block - PT 4-WE/18 - 3044923

Accessories

Plug-in bridge - FBSR 4-5 - 3001592



Plug-in bridge, pitch: 5.2 mm, number of positions: 4, color: red

Plug-in bridge - FBSR 5-5 - 3001593



Plug-in bridge, pitch: 5.2 mm, number of positions: 5, color: red

Plug-in bridge - FBSR 10-5 - 3033710



Plug-in bridge, pitch: 5.2 mm, number of positions: 10, color: red

Plug-in bridge - FBS 2-5 BU - 3036877



Plug-in bridge, pitch: 5.2 mm, number of positions: 2, color: blue

Plug-in bridge - FBS 3-5 BU - 3036880



Plug-in bridge, pitch: 5.2 mm, number of positions: 3, color: blue

Panel feed-through terminal block - PT 4-WE/18 - 3044923

Accessories

Plug-in bridge - FBS 4-5 BU - 3036893



Plug-in bridge, pitch: 5.2 mm, number of positions: 4, color: blue

Plug-in bridge - FBS 5-5 BU - 3036903



Plug-in bridge, pitch: 5.2 mm, number of positions: 5, color: blue

Plug-in bridge - FBS 10-5 BU - 3036916



Plug-in bridge, pitch: 5.2 mm, number of positions: 10, color: blue

Plug-in bridge - FBS 20-5 BU - 3036929



Plug-in bridge, pitch: 5.2 mm, number of positions: 20, color: blue

Plug-in bridge - FBS 50-5 BU - 3032114



Plug-in bridge, pitch: 5.2 mm, number of positions: 50, color: blue

Labeled terminal marker

Panel feed-through terminal block - PT 4-WE/18 - 3044923

Accessories

Zack Marker strip, flat - ZBF 5 CUS - 0825025



Zack Marker strip, flat, can be ordered: Strip, white, labeled according to customer specifications, mounting type: snap into flat marker groove, for terminal block width: 5 mm, lettering field size: 5.15 x 5.15 mm, Number of individual labels: 10

Zack Marker strip, flat - ZBF 5,LGS:FORTL.ZAHLEN - 0808671



Zack Marker strip, flat, Strip, white, labeled, printed horizontally: consecutive numbers 1 ... 10, 11 ... 20, etc. up to 491 ... 500, mounting type: snap into flat marker groove, for terminal block width: 5 mm, lettering field size: 5.15 x 5.15 mm, Number of individual labels: 10

Zack Marker strip, flat - ZBF 5,QR:FORTL.ZAHLEN - 0808697



Zack Marker strip, flat, Strip, white, labeled, Printed vertically: consecutive numbers 1 ... 10, 11 ... 20, etc. up to 91 ... 100, mounting type: snap into flat marker groove, for terminal block width: 5 mm, lettering field size: 5.15 x 5.15 mm, Number of individual labels: 10

Zack Marker strip, flat - ZBF 5,LGS:GERADE ZAHLEN - 0810821



Zack Marker strip, flat, Strip, white, labeled, printed horizontally: consecutive numbers 2 ... 20, 22 ... 40, etc. up to 82 ... 100, mounting type: snap into flat marker groove, for terminal block width: 5 mm, lettering field size: 5.15 x 5.15 mm, Number of individual labels: 10

Zack Marker strip, flat - ZBF 5,LGS:UNGERADE ZAHLEN - 0810863



Zack Marker strip, flat, Strip, white, labeled, printed horizontally: Odd numbers 1 - 19, 21 - 39, etc. up to 81 - 99, mounting type: snap into flat marker groove, for terminal block width: 5 mm, lettering field size: 5.15 x 5.15 mm, Number of individual labels: 10

Panel feed-through terminal block - PT 4-WE/18 - 3044923

Accessories

Marker for terminal blocks - UC-TMF 5 CUS - 0824638



Marker for terminal blocks, can be ordered: by sheet, white, labeled according to customer specifications, mounting type: snap into flat marker groove, for terminal block width: 5.2 mm, lettering field size: 4.6 x 5.1 mm, Number of individual labels: 96

Marker for terminal blocks - UCT-TMF 5 CUS - 0829658



Marker for terminal blocks, can be ordered: by sheet, white, labeled according to customer specifications, mounting type: snap into flat marker groove, for terminal block width: 5.2 mm, lettering field size: 4.4 x 4.7 mm, Number of individual labels: 72

Partition plate

Spacer plate - DP PS-5 - 3036725



Spacer plate, length: 22.4 mm, width: 5.2 mm, height: 29 mm, number of positions: 1, color: red

Screwdriver tools

Screwdriver - SZF 1-0,6X3,5 - 1204517



Actuation tool, for ST terminal blocks, also suitable for use as a bladed screwdriver, size: 0.6 x 3.5 x 100 mm, 2-component grip, with non-slip grip

Actuation tool - ST-BW - 1207608



Actuation tool, for all 2.5 mm² - 4.0 mm² spring-cages

Terminal marking

Panel feed-through terminal block - PT 4-WE/18 - 3044923

Accessories

Zack Marker strip, flat - ZBF 5:UNBEDRUCKT - 0808642



Zack Marker strip, flat, Strip, white, unlabeled, can be labeled with: PLOTMARK, CMS-P1-PLOTTER, mounting type: snap into flat marker groove, for terminal block width: 5 mm, lettering field size: 5.1 x 5.2 mm, Number of individual labels: 10

Marker for terminal blocks - UC-TMF 5 - 0818153



Marker for terminal blocks, Sheet, white, unlabeled, can be labeled with: BLUEMARK ID COLOR, BLUEMARK ID, BLUEMARK CLED, PLOTMARK, CMS-P1-PLOTTER, mounting type: snap into flat marker groove, for terminal block width: 5.2 mm, lettering field size: 4.6 x 5.1 mm, Number of individual labels: 96

Marker for terminal blocks - UCT-TMF 5 - 0828744



Marker for terminal blocks, Sheet, white, unlabeled, can be labeled with: TOPMARK NEO, TOPMARK LASER, BLUEMARK ID COLOR, BLUEMARK ID, BLUEMARK CLED, THERMOMARK PRIME, THERMOMARK CARD 2.0, THERMOMARK CARD, mounting type: snap into flat marker groove, for terminal block width: 5.2 mm, lettering field size: 4.4 x 4.7 mm, Number of individual labels: 72

Test plug terminal block

Test plugs - PS-5 - 3030983



Test plugs, Modular test plug, color: red

Test plugs - PS-5/2,3MM RD - 3038723



Test plugs, color: red

Test socket

Panel feed-through terminal block - PT 4-WE/18 - 3044923

Accessories

Test adapter - PAI-4 - 3030925



Test adapter, for 4 mm test plug and terminal blocks with 4.2 mm ... 8.2 mm pitch, color: gray

Phoenix Contact 2020 © - all rights reserved
<http://www.phoenixcontact.com>

PHOENIX CONTACT GmbH & Co. KG
Flachsmarktstr. 8
32825 Blomberg
Germany
Tel. +49 5235 300
Fax +49 5235 3 41200
<http://www.phoenixcontact.com>

X-ON Electronics

Largest Supplier of Electrical and Electronic Components

Click to view similar products for [Fixed Terminal Blocks](#) category:

Click to view products by [Phoenix Contact](#) manufacturer:

Other Similar products are found below :

[MBE-1512](#) [MBE-154](#) [MBE-156](#) [MBES-153](#) [MBES-156](#) [MH-2512](#) [MHE-132](#) [MHE-163](#) [MI-254 \(35\)](#) [MI-272](#) [880507](#) [MPT-275](#)
[15602-04-08-21](#) [BA311TU](#) [BA411SU](#) [MV-152](#) [MV-252-D](#) [MV-253/NCNOC](#) [MV-254-D](#) [MV-255](#) [MV-462](#) [MV-493](#) [MVE-252](#) [MVE-253](#)
[MVE-273](#) [MVEB-153](#) [1700096](#) [1705142](#) [1712417](#) [1713020](#) [1713088](#) [1745195](#) [1760594](#) [1776118-2](#) [1790852](#) [1-796689-8](#) [1-796692-6](#)
[1800001](#) [1800114](#) [1995279](#) [20020314-C121B01LF](#) [CB2-12](#) [KP03215000J0G](#) [KP04215000J0G](#) [S451](#) [282802-2](#) [29.007](#) [29.116](#) [30.103](#)
[30.106](#)