

## Ferrule - AI 2,5 -12 BU - 3200962

Please be informed that the data shown in this PDF Document is generated from our Online Catalog. Please find the complete data in the user's documentation. Our General Terms of Use for Downloads are valid (<http://phoenixcontact.com/download>)



Ferrule, sleeve length: 12 mm, length: 18 mm, color: blue

### Your advantages

- ✓ The insulation reliability of close connections is increased and the splicing of wires is prevented
- ✓ The AI 0,25.. ferrules can also be used to process 0.14 mm<sup>2</sup> conductors
- ✓ The ferrules with plastic sleeve are made from soft tin-plated electrolytic copper

### Key Commercial Data

Packing unit	100 pc
Minimum order quantity	100 pc
GTIN	 4 017918 094515
GTIN	4017918094515
Sales Key	05

### Technical data

#### Dimensions

Length (b)	18 mm
Maximum stripping length	15 mm
Sleeve length	12 mm
Inner dimension of the insulating collar (d)	4.2 mm
Ferrule diameter	2.3 mm
Insulating collar thickness	0.3 mm
Sleeve wall thickness	0.15 mm

#### Ambient conditions

Short-term temperature	120 °C
Max. permanent temperature	105 °C (-40°C no load / 0°C dynamic load)

# Ferrule - Al 2,5 -12 BU - 3200962

## Technical data

### General

Color	blue
Components	free from silicone and halogen
Flammability rating according to UL 94	HB
Material	CU-DHP
Coating	tin-plated (galvanic)
Conductor category	Stranded conductors, class 2, 5, 6 / B, C, K, M

### Standards and Regulations

Connection in acc. with standard	CSA
Flammability rating according to UL 94	HB

### Environmental Product Compliance

China RoHS	Environmentally friendly use period: unlimited = EFUP-e
	No hazardous substances above threshold values

## Drawings

Dimensional drawing

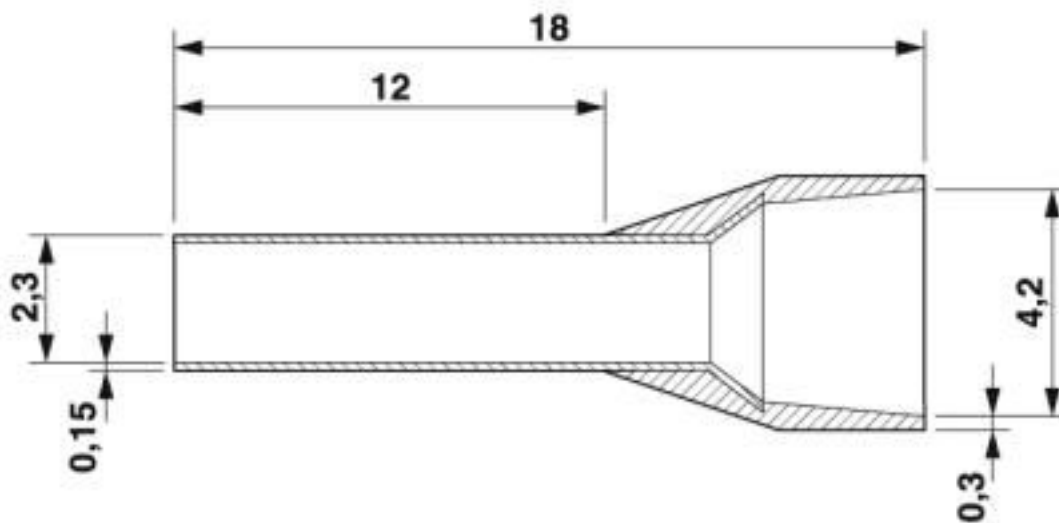

## Classifications

### eCl@ss

eCl@ss 10.0.1	27400201
eCl@ss 4.0	27060700
eCl@ss 4.1	27060700
eCl@ss 5.0	27400200
eCl@ss 5.1	27400200
eCl@ss 6.0	27400200

# Ferrule - AI 2,5 -12 BU - 3200962

## Classifications

### eCl@ss

eCl@ss 7.0	27400201
eCl@ss 8.0	27400201
eCl@ss 9.0	27400201

### ETIM

ETIM 2.0	EC000005
ETIM 3.0	EC000005
ETIM 4.0	EC000005
ETIM 5.0	EC000005
ETIM 6.0	EC000005
ETIM 7.0	EC000005

### UNSPSC

UNSPSC 6.01	30212109
UNSPSC 7.0901	27121703
UNSPSC 11	27121703
UNSPSC 12.01	27121703
UNSPSC 13.2	27121703
UNSPSC 18.0	27121703
UNSPSC 19.0	27121703
UNSPSC 20.0	27121703
UNSPSC 21.0	27121703

## Approvals

### Approvals

---

#### Approvals

CSA / UL Listed / cUL Listed / CSAus / cULus Listed / cCSAus

---

#### Ex Approvals





---

### Approval details

CSA		<a href="http://www.csagroup.org/services-industries/product-listing/">http://www.csagroup.org/services-industries/product-listing/</a>	247397
-----	--	-----------------------------------------------------------------------------------------------------------------------------------------	--------

## Ferrule - AI 2,5 -12 BU - 3200962

### Approvals

UL Listed		<a href="http://database.ul.com/cgi-bin/XYV/template/LISEXT/1FRAME/index.htm">http://database.ul.com/cgi-bin/XYV/template/LISEXT/1FRAME/index.htm</a>	E488001
cUL Listed		<a href="http://database.ul.com/cgi-bin/XYV/template/LISEXT/1FRAME/index.htm">http://database.ul.com/cgi-bin/XYV/template/LISEXT/1FRAME/index.htm</a>	E488001
CSAus		<a href="http://www.csagroup.org/services-industries/product-listing/">http://www.csagroup.org/services-industries/product-listing/</a>	247397
cULus Listed			
cCSAus			

Phoenix Contact 2020 © - all rights reserved  
<http://www.phoenixcontact.com>

PHOENIX CONTACT GmbH & Co. KG  
Flachsmarktstr. 8  
32825 Blomberg  
Germany  
Tel. +49 5235 300  
Fax +49 5235 3 41200  
<http://www.phoenixcontact.com>

## X-ON Electronics

Largest Supplier of Electrical and Electronic Components

*Click to view similar products for [Terminals](#) category:*

*Click to view products by [Phoenix Contact](#) manufacturer:*

Other Similar products are found below :

[00-054007-01074-6](#) [00-054007-70206-1](#) [00-054007-70210-8](#) [00-054007-70217-7](#) [00-054007-70226-9](#) [00-054007-70228-3](#) [00-054007-70248-1](#) [00-054007-70256-6](#) [00-054007-70301-3](#) [00-054007-70316-7](#) [0-0320562-0](#) [00-054007-49560-4](#) [00-054007-70209-2](#) [00-054007-70225-2](#) [00-054007-70227-6](#) [00-054007-70231-3](#) [00-054007-70241-2](#) [00-054007-70242-9](#) [00-054007-70244-3](#) [00-054007-70246-7](#) [00-054007-70263-4](#) [00-054007-70288-7](#) [00-054007-70290-0](#) [00-054007-70300-6](#) [00-054007-70304-4](#) [01-2065-1-0216](#) [01-2900-1-04412](#) [00581P0075](#) [600TS-10](#) [60205-1](#) [604200-1](#) [605601-1](#) [60598-1-CUT-TAPE](#) [61314-6-C](#) [61810-3](#) [61-S](#) [61-SN](#) [626-0194](#) [62-NBM-A](#) [62-SN](#) [62-SP](#) [63-S](#) [640179-1](#) [M55155/059I03](#) [M55155/079C01](#) [M55155/099H02](#) [M55155/109H01](#) [M55155/109H02](#) [M55155/12XH05](#) [M55155/16XH02](#)