

Double-level terminal block - PTTBS 2,5-QUATTRO-PE - 3210611

Please be informed that the data shown in this PDF Document is generated from our Online Catalog. Please find the complete data in the user's documentation. Our General Terms of Use for Downloads are valid (<http://phoenixcontact.com/download>)

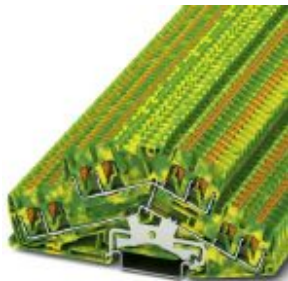

Double-level terminal block, connection method: Push-in connection, number of connections: 8, cross section: 0.14 mm² - 4 mm², AWG: 26 - 12, width: 5.2 mm, color: green-yellow, mounting type: NS 35/7,5, NS 35/15

Your advantages

- ✓ In addition to the testing facility in the double function shaft, all terminal blocks provide an additional test connection
- ✓ The Push-in connection terminal blocks are characterized by the system features of the CLIPLINE complete system and by easy and tool-free wiring of conductors with ferrules or solid conductors
- ✓ The compact design and front connection enable wiring in a confined space



Key Commercial Data

Packing unit	50 pc
GTIN	 4 055626 004471
GTIN	4055626004471

Technical data

General

Number of levels	2
Number of connections	8
Nominal cross section	2.5 mm ²
Color	green-yellow
Insulating material	PA
Flammability rating according to UL 94	V0
Rated surge voltage	6 kV
Overvoltage category	III
Insulating material group	I
Ambient temperature (operation)	-60 °C ... 85 °C
Ambient temperature (storage/transport)	-25 °C ... 55 °C (For a short time, not exceeding 24 h, -60 to +70 °C)
Permissible humidity (storage/transport)	30 % ... 70 %
Ambient temperature (assembly)	-5 °C ... 70 °C

Double-level terminal block - PTTBS 2,5-QUATTRO-PE - 3210611

Technical data

General

Ambient temperature (actuation)	-5 °C ... 70 °C
Connection in acc. with standard	IEC 60947-7-1
Maximum load current	with 4 mm ² conductor cross section, rigid
Open side panel	Yes
Shock protection test specification	DIN EN 50274 (VDE 0660-514):2002-11
Back of the hand protection	guaranteed
Finger protection	guaranteed
Oscillation, broadband noise test result	Test passed
Test specification, oscillation, broadband noise	DIN EN 50155 (VDE 0115-200):2008-03
Test spectrum	Service life test category 2, bogie-mounted
Test frequency	f ₁ = 5 Hz to f ₂ = 250 Hz
ASD level	6.12 (m/s ²) ² /Hz
Acceleration	3.12 g
Test duration per axis	5 h
Test directions	X-, Y- and Z-axis
Shock test result	Test passed
Test specification, shock test	DIN EN 50155 (VDE 0115-200):2008-03
Shock form	Half-sine
Acceleration	30g
Shock duration	18 ms
Number of shocks per direction	3
Test directions	X-, Y- and Z-axis (pos. and neg.)
Relative insulation material temperature index (Elec.; UL 746 B)	130 °C
Temperature index of insulation material (DIN EN 60216-1 (VDE 0304-21))	125 °C
Static insulating material application in cold	-60 °C
Surface flammability NFPA 130 (ASTM E 162)	passed
Specific optical density of smoke NFPA 130 (ASTM E 662)	passed
Smoke gas toxicity NFPA 130 (SMP 800C)	passed
Calorimetric heat release NFPA 130 (ASTM E 1354)	27,5 MJ/kg
Fire protection for rail vehicles (DIN EN 45545-2) R22	HL 1 - HL 3
Fire protection for rail vehicles (DIN EN 45545-2) R23	HL 1 - HL 3
Fire protection for rail vehicles (DIN EN 45545-2) R24	HL 1 - HL 3
Fire protection for rail vehicles (DIN EN 45545-2) R26	HL 1 - HL 3

Dimensions

Width	5.2 mm
Length	115.2 mm
Height NS 35/7,5	55 mm
Height NS 35/15	62.5 mm

Connection data

Double-level terminal block - PTTBS 2,5-QUATTRO-PE - 3210611

Technical data

Connection data

Connection method	Push-in connection
Conductor cross section solid min.	0.14 mm ²
Conductor cross section solid max.	4 mm ²
Conductor cross section flexible min.	0.14 mm ²
Conductor cross section flexible max.	4 mm ²
Conductor cross section AWG min.	26
Conductor cross section AWG max.	12
Conductor cross section flexible, with ferrule without plastic sleeve min.	0.14 mm ²
Conductor cross section flexible, with ferrule without plastic sleeve max.	2.5 mm ²
Conductor cross section flexible, with ferrule with plastic sleeve min.	0.14 mm ²
Conductor cross section flexible, with ferrule with plastic sleeve max.	2.5 mm ²
Two conductors with the same cross section, flexible, with TWIN ferrules, with plastic sleeve, maximum	0.5 mm ²
Stripping length	8 mm ... 10 mm
Internal cylindrical gage	A3

Standards and Regulations

Connection in acc. with standard	IEC 60947-7-1
Flammability rating according to UL 94	V0

Environmental Product Compliance

China RoHS	Environmentally friendly use period: unlimited = EFUP-e
	No hazardous substances above threshold values

Drawings

Double-level terminal block - PTTBS 2,5-QUATTRO-PE - 3210611

Circuit diagram

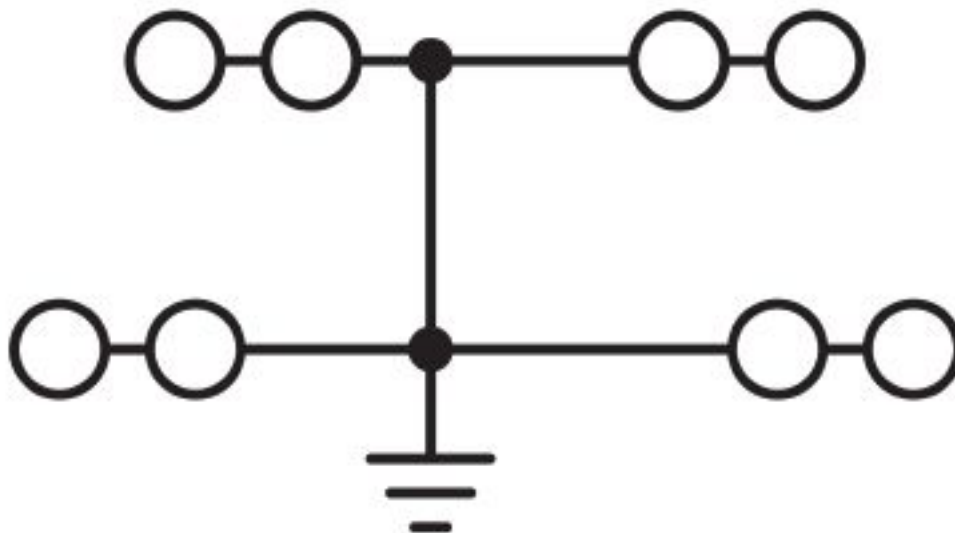

Classifications

eCl@ss

eCl@ss 10.0.1	27141141
eCl@ss 5.0	27141100
eCl@ss 5.1	27141100
eCl@ss 6.0	27141100
eCl@ss 7.0	27141141
eCl@ss 8.0	27141141
eCl@ss 9.0	27141141

ETIM

ETIM 5.0	EC000901
ETIM 6.0	EC000901
ETIM 7.0	EC000901

UNSPSC

UNSPSC 13.2	39121410
UNSPSC 18.0	39121410
UNSPSC 19.0	39121410
UNSPSC 20.0	39121410
UNSPSC 21.0	39121410

Double-level terminal block - PTTBS 2,5-QUATTRO-PE - 3210611

Approvals

Approvals

Approvals

DNV GL / CSA / LR / UL Recognized / cUL Recognized / EAC / RS / EAC / cULus Recognized

Ex Approvals

Approval details

DNV GL		https://approvalfinder.dnvgl.com/	TAE00003JE
--------	---	---	------------

CSA		http://www.csagroup.org/services-industries/product-listing/	13631
		B	C
mm ² /AWG/kcmil		26-12	26-12

LR		http://www.lr.org/en	16/20026
----	---	---	----------

UL Recognized		http://database.ul.com/cgi-bin/XYV/template/LISEXT/1FRAME/index.htm	FILE E 60425
		B	C
mm ² /AWG/kcmil		26-12	26-12

cUL Recognized		http://database.ul.com/cgi-bin/XYV/template/LISEXT/1FRAME/index.htm	FILE E 60425
		B	C
mm ² /AWG/kcmil		26-12	26-12

EAC			RU C- DE.AI30.B.01102
-----	---	--	--------------------------

Double-level terminal block - PTTBS 2,5-QUATTRO-PE - 3210611

Approvals

RS		http://www.rs-head.spb.ru/en/index.php	17.00013.272
----	--	---	--------------

EAC			RU C- DE.BL08.B.00644
-----	--	--	--------------------------

cULus Recognized			
------------------	--	--	--

Accessories

Accessories

Crimping tool

Crimping pliers - CRIMPFOX CENTRUS 6S - 1213144



Crimping pliers, for uninsulated and insulated ferrules, DIN 46228 Part 1 and 4, from 0.14 mm² ... 6 mm², also for TWIN ferrules up to 2 x 4 mm², automatic cross section adjustment, lateral insertion, equipped with fall protection

Crimping pliers - CRIMPFOX CENTRUS 10S - 1213154



Crimping pliers, for uninsulated and insulated ferrules, DIN 46228 Part 1 and 4, from 0.14 mm² ... 10 mm², also for TWIN ferrules up to 2 x 4 mm², automatic cross section adjustment, lateral insertion, equipped with fall protection

Crimping pliers - CRIMPFOX CENTRUS 6H - 1213146



Crimping pliers, for uninsulated and insulated ferrules, DIN 46228 Part 1 and 4, from 0.14 mm² ... 6 mm², also for TWIN ferrules up to 2 x 4 mm², automatic cross section adjustment, lateral insertion, equipped with fall protection

Double-level terminal block - PTTBS 2,5-QUATTRO-PE - 3210611

Accessories

Crimping pliers - CRIMPFOX CENTRUS 10H - 1213156



Crimping pliers, for uninsulated and insulated ferrules, DIN 46228 Part 1 and 4, from 0.14 mm² ... 10 mm², also for TWIN ferrules up to 2 x 4 mm², automatic cross section adjustment, lateral insertion, equipped with fall protection

Crimping pliers - CRIMPFOX 10S - 1212045



Crimping pliers, for ferrules without insulating collar according to DIN 46228 Part 1 and ferrules with insulating collar according to DIN 46228 Part 4, 0.14 mm² ... 10 mm², unlockable pressure lock, lateral entry

Crimping pliers - CRIMPFOX 6H - 1212046



Crimping pliers, for ferrules without insulating collar according to DIN 46228 Part 1 and ferrules with insulating collar according to DIN 46228 Part 4, 0.14 mm² ... 6 mm², unlockable pressure lock, lateral entry

Crimping pliers - CRIMPFOX 2,5-M - 1212719



Crimping pliers, for ferrules without insulating collar according to DIN 46228 Part 1 and ferrules with insulating collar according to DIN 46228 Part 4, 0.25 mm² ... 2.5 mm², lateral entry, trapezoidal crimp

Crimping pliers - CRIMPFOX 6-M - 1212720



Crimping pliers, for ferrules without insulating collar according to DIN 46228 Part 1 and ferrules with insulating collar according to DIN 46228 Part 4, 0.25 mm² ... 6.0 mm², lateral entry, trapezoidal crimp

Double-level terminal block - PTTBS 2,5-QUATTRO-PE - 3210611

Accessories

Crimping pliers - CRIMPFOX 6 - 1212034



Crimping pliers, for ferrules without insulating collar according to DIN 46228 Part 1 and ferrules with insulating collar according to DIN 46228 Part 4, 0.25 mm² ... 6.0 mm², lateral entry, trapezoidal crimp

Crimping pliers - CRIMPFOX 6T - 1212037



Crimping pliers, for ferrules without insulating collar according to DIN 46228 Part 1 and ferrules with insulating collar according to DIN 46228 Part 4, 0.25 mm² ... 6 mm², lateral entry, trapezoidal crimp

Crimping pliers - CRIMPFOX 6T-F - 1212038



Crimping pliers, for ferrules without insulating collar according to DIN 46228 Part 1 and ferrules with insulating collar according to DIN 46228 Part 4, 0.25 mm² ... 6 mm², front entry, trapezoidal crimp

Crimping pliers - CRIMPFOX 6S-F - 1212043



Crimping pliers, for ferrules without insulating collar according to DIN 46228 Part 1 and ferrules with insulating collar according to DIN 46228 Part 4, 0.5 mm² ... 6 mm², front entry, square crimp

Crimping pliers - CRIMPFOX-M - 1212072



Basic pliers, for accommodating dies for a wide range of type of contacts

DIN rail

Double-level terminal block - PTTBS 2,5-QUATTRO-PE - 3210611

Accessories

DIN rail perforated - NS 35/ 7,5 PERF 2000MM - 0801733



DIN rail perforated, Standard profile, width: 35 mm, height: 7.5 mm, acc. to EN 60715, material: Steel, galvanized, passivated with a thick layer, length: 2000 mm, color: silver

DIN rail, unperforated - NS 35/ 7,5 UNPERF 2000MM - 0801681



DIN rail, unperforated, Standard profile, width: 35 mm, height: 7.5 mm, acc. to EN 60715, material: Steel, galvanized, passivated with a thick layer, length: 2000 mm, color: silver

DIN rail perforated - NS 35/ 7,5 WH PERF 2000MM - 1204119



DIN rail perforated, Standard profile, width: 35 mm, height: 7.5 mm, acc. to EN 60715, material: Steel, Galvanized, white passivated, length: 2000 mm, color: silver

DIN rail, unperforated - NS 35/ 7,5 WH UNPERF 2000MM - 1204122



DIN rail, unperforated, Standard profile, width: 35 mm, height: 7.5 mm, acc. to EN 60715, material: Steel, Galvanized, white passivated, length: 2000 mm, color: silver

DIN rail, unperforated - NS 35/ 7,5 AL UNPERF 2000MM - 0801704



DIN rail, unperforated, Standard profile, width: 35 mm, height: 7.5 mm, acc. to EN 60715, material: Aluminum, uncoated, length: 2000 mm, color: silver

Double-level terminal block - PTTBS 2,5-QUATTRO-PE - 3210611

Accessories

DIN rail perforated - NS 35/ 7,5 ZN PERF 2000MM - 1206421



DIN rail perforated, Standard profile, width: 35 mm, height: 7.5 mm, acc. to EN 60715, material: Steel, galvanized, length: 2000 mm, color: silver

DIN rail, unperforated - NS 35/ 7,5 ZN UNPERF 2000MM - 1206434



DIN rail, unperforated, Standard profile, width: 35 mm, height: 7.5 mm, acc. to EN 60715, material: Steel, galvanized, length: 2000 mm, color: silver

DIN rail, unperforated - NS 35/ 7,5 CU UNPERF 2000MM - 0801762



DIN rail, unperforated, Standard profile, width: 35 mm, height: 7.5 mm, acc. to EN 60715, material: Copper, uncoated, length: 2000 mm, color: copper-colored

End cap - NS 35/ 7,5 CAP - 1206560



DIN rail end piece, for DIN rail NS 35/7.5

DIN rail perforated - NS 35/15 PERF 2000MM - 1201730



DIN rail perforated, Standard profile, width: 35 mm, height: 15 mm, similar to EN 60715, material: Steel, galvanized, passivated with a thick layer, length: 2000 mm, color: silver

Double-level terminal block - PTTBS 2,5-QUATTRO-PE - 3210611

Accessories

DIN rail, unperforated - NS 35/15 UNPERF 2000MM - 1201714

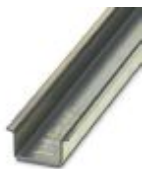

DIN rail, unperforated, Standard profile, width: 35 mm, height: 15 mm, similar to EN 60715, material: Steel, galvanized, passivated with a thick layer, length: 2000 mm, color: silver

DIN rail perforated - NS 35/15 WH PERF 2000MM - 0806602



DIN rail perforated, Standard profile, width: 35 mm, height: 15 mm, similar to EN 60715, material: Steel, Galvanized, white passivated, length: 2000 mm, color: silver

DIN rail, unperforated - NS 35/15 WH UNPERF 2000MM - 1204135



DIN rail, unperforated, Standard profile, width: 35 mm, height: 15 mm, similar to EN 60715, material: Steel, Galvanized, white passivated, length: 2000 mm, color: silver

DIN rail, unperforated - NS 35/15 AL UNPERF 2000MM - 1201756



DIN rail, unperforated, Standard profile, width: 35 mm, height: 15 mm, similar to EN 60715, material: Aluminum, uncoated, length: 2000 mm, color: silver

DIN rail perforated - NS 35/15 ZN PERF 2000MM - 1206599



DIN rail perforated, Standard profile, width: 35 mm, height: 15 mm, similar to EN 60715, material: Steel, galvanized, length: 2000 mm, color: silver

Double-level terminal block - PTTBS 2,5-QUATTRO-PE - 3210611

Accessories

DIN rail, unperforated - NS 35/15 ZN UNPERF 2000MM - 1206586



DIN rail, unperforated, Standard profile, width: 35 mm, height: 15 mm, similar to EN 60715, material: Steel, galvanized, length: 2000 mm, color: silver

DIN rail, unperforated - NS 35/15 CU UNPERF 2000MM - 1201895



DIN rail, unperforated, Standard profile, width: 35 mm, height: 15 mm, similar to EN 60715, material: Copper, uncoated, length: 2000 mm, color: copper-colored

End cap - NS 35/15 CAP - 1206573



DIN rail end piece, for DIN rail NS 35/15

DIN rail, unperforated - NS 35/15-2,3 UNPERF 2000MM - 1201798



DIN rail, unperforated, Standard profile 2.3 mm, width: 35 mm, height: 15 mm, acc. to EN 60715, material: Steel, galvanized, passivated with a thick layer, length: 2000 mm, color: silver

Documentation

Mounting material - PT-IL - 3208090



Operating decal for the push-in Technology

End block

Double-level terminal block - PTTBS 2,5-QUATTRO-PE - 3210611

Accessories

End clamp - CLIPFIX 35 - 3022218



Quick mounting end clamp for NS 35/7,5 DIN rail or NS 35/15 DIN rail, with marking option, width: 9.5 mm, color: gray

End clamp - CLIPFIX 35-5 - 3022276



Quick mounting end clamp for NS 35/7,5 DIN rail or NS 35/15 DIN rail, with marking option, with parking option for FBS...5, FBS...6, KSS 5, KSS 6, width: 5.15 mm, color: gray

End clamp - E/NS 35 N - 0800886



End clamp, width: 9.5 mm, color: gray

End cover

End cover - D-PTTBS 2,5-QUATTRO - 3210613



End cover, length: 115.2 mm, width: 2.2 mm, height: 45.8 mm, color: gray

Filler plug

Filler plugs - CEC 2,5 - 3062757



Cover for conductor shaft, 10-pos., for spring cage terminal blocks (ST) and terminal blocks with push-in technology (PT) with a width of 5.2 mm

Insulating sleeve

Double-level terminal block - PTTBS 2,5-QUATTRO-PE - 3210611

Accessories

Insulating sleeve - MPS-IH WH - 0201663

Insulating sleeve, color: white



Insulating sleeve - MPS-IH RD - 0201676

Insulating sleeve, color: red



Insulating sleeve - MPS-IH BU - 0201689

Insulating sleeve, color: blue



Insulating sleeve - MPS-IH YE - 0201692

Insulating sleeve, color: yellow



Insulating sleeve - MPS-IH GN - 0201702

Insulating sleeve, color: green



Double-level terminal block - PTTBS 2,5-QUATTRO-PE - 3210611

Accessories

Insulating sleeve - MPS-IH GY - 0201728

Insulating sleeve, color: gray



Insulating sleeve - MPS-IH BK - 0201731

Insulating sleeve, color: black



Insulating sleeve - ISH 2,5/0,2 - 3002843

Insulating sleeve, color: white



Insulating sleeve - ISH 2,5/0,5 - 3002856

Insulating sleeve, color: gray



Insulating sleeve - ISH 2,5/1,0 - 3002869

Insulating sleeve, color: black



Labeled terminal marker

Double-level terminal block - PTTBS 2,5-QUATTRO-PE - 3210611

Accessories

Zack marker strip - ZB 5 CUS - 0824962



Zack marker strip, can be ordered: Strip, white, labeled according to customer specifications, mounting type: snap into tall marker groove, for terminal block width: 5.2 mm, lettering field size: 5.15 x 10.5 mm, Number of individual labels: 10

Zack marker strip - ZB 5,LGS:FORTL.ZAHLEN - 1050017



Zack marker strip, Strip, white, labeled, printed horizontally: consecutive numbers 1 ... 10, 11 ... 20, etc. up to 491 ... 500, mounting type: snap into tall marker groove, for terminal block width: 5.2 mm, lettering field size: 5.15 x 10.5 mm, Number of individual labels: 10

Zack marker strip - ZB 5,QR:FORTL.ZAHLEN - 1050020



Zack marker strip, white, Printed vertically: consecutive numbers 1 ... 10, 11 ... 20, etc. up to 491 ... 500, mounting type: snap into tall marker groove, for terminal block width: 5.2 mm, lettering field size: 5.15 x 10.5 mm

Zack marker strip - ZB 5,LGS:GLEICHE ZAHLEN - 1050033



Zack marker strip, Strip, white, labeled, can be labeled with: CMS-P1-PLOTTER, printed horizontally: Identical numbers 1 or 2, etc. up to 100, mounting type: snap into tall marker groove, for terminal block width: 5.2 mm, lettering field size: 5.15 x 10.5 mm, Number of individual labels: 10

Zack marker strip - ZB 5,LGS:L1-N,PE - 1050415



Zack marker strip, Strip, white, labeled, horizontal: L1, L2, L3, N, PE, L1, L2, L3, N, PE, mounting type: snap into tall marker groove, for terminal block width: 5.2 mm, lettering field size: 5.15 x 10.5 mm, Number of individual labels: 10

Double-level terminal block - PTTBS 2,5-QUATTRO-PE - 3210611

Accessories

Marker for terminal blocks - UC-TM 5 CUS - 0824581



Marker for terminal blocks, can be ordered: by sheet, white, labeled according to customer specifications, mounting type: snap into tall marker groove, for terminal block width: 5.2 mm, lettering field size: 10.5 x 4.6 mm, Number of individual labels: 96

Marker for terminal blocks - UCT-TM 5 CUS - 0829595



Marker for terminal blocks, can be ordered: by sheet, white, labeled according to customer specifications, mounting type: snap into tall marker groove, for terminal block width: 5.2 mm, lettering field size: 4.6 x 10.5 mm, Number of individual labels: 72

Zack Marker strip, flat - ZBF 5 CUS - 0825025



Zack Marker strip, flat, can be ordered: Strip, white, labeled according to customer specifications, mounting type: snap into flat marker groove, for terminal block width: 5 mm, lettering field size: 5.15 x 5.15 mm, Number of individual labels: 10

Zack Marker strip, flat - ZBF 5,LGS:FORTL.ZAHLEN - 0808671



Zack Marker strip, flat, Strip, white, labeled, printed horizontally: consecutive numbers 1 ... 10, 11 ... 20, etc. up to 491 ... 500, mounting type: snap into flat marker groove, for terminal block width: 5 mm, lettering field size: 5.15 x 5.15 mm, Number of individual labels: 10

Zack Marker strip, flat - ZBF 5,QR:FORTL.ZAHLEN - 0808697



Zack Marker strip, flat, Strip, white, labeled, Printed vertically: consecutive numbers 1 ... 10, 11 ... 20, etc. up to 91 ... 100, mounting type: snap into flat marker groove, for terminal block width: 5 mm, lettering field size: 5.15 x 5.15 mm, Number of individual labels: 10

Double-level terminal block - PTTBS 2,5-QUATTRO-PE - 3210611

Accessories

Zack Marker strip, flat - ZBF 5,LGS:GERADE ZAHLEN - 0810821



Zack Marker strip, flat, Strip, white, labeled, printed horizontally: consecutive numbers 2 ... 20, 22 ... 40, etc. up to 82 ... 100, mounting type: snap into flat marker groove, for terminal block width: 5 mm, lettering field size: 5.15 x 5.15 mm, Number of individual labels: 10

Zack Marker strip, flat - ZBF 5,LGS:UNGERADE ZAHLEN - 0810863



Zack Marker strip, flat, Strip, white, labeled, printed horizontally: Odd numbers 1 - 19, 21 - 39, etc. up to 81 - 99, mounting type: snap into flat marker groove, for terminal block width: 5 mm, lettering field size: 5.15 x 5.15 mm, Number of individual labels: 10

Marker for terminal blocks - UC-TMF 5 CUS - 0824638



Marker for terminal blocks, can be ordered: by sheet, white, labeled according to customer specifications, mounting type: snap into flat marker groove, for terminal block width: 5.2 mm, lettering field size: 4.6 x 5.1 mm, Number of individual labels: 96

Marker for terminal blocks - UCT-TMF 5 CUS - 0829658



Marker for terminal blocks, can be ordered: by sheet, white, labeled according to customer specifications, mounting type: snap into flat marker groove, for terminal block width: 5.2 mm, lettering field size: 4.4 x 4.7 mm, Number of individual labels: 72

Marker carriers

Marker carriers - STP 5-2-ZB - 3037643



Double marker carrier, snaps onto the spring-cage terminal blocks ST 2.5..., labeled with ZB 5 or ZBF 5

Double-level terminal block - PTTBS 2,5-QUATTRO-PE - 3210611

Accessories

Group marker label for terminal marking - GBS-ZB/26X6 - 0809298



Group marking label, snaps onto terminal center for screw, spring-cage and quick connection terminal blocks, labeled with ESL 26x6 mm or EST 25x6 mm, in the foot part with Zack marker strip, length: 29 mm

Partition plate

Partition plate - ATP-STTB 4 - 3030747



Partition plate, length: 88.7 mm, width: 2 mm, height: 53 mm, color: gray

Spacer plate - DP PS-5 - 3036725



Spacer plate, length: 22.4 mm, width: 5.2 mm, height: 29 mm, number of positions: 1, color: red

Planning and marking software

Software - CLIP-PROJECT ADVANCED - 5146040



Multilingual software for convenient configuration of Phoenix Contact products on standard DIN rails.

Software - CLIP-PROJECT PROFESSIONAL - 5146053



Multilingual software for terminal strip configuration. A marking module enables the professional marking of markers and labels for identifying terminal blocks, conductors and cables, and devices.

Screwdriver tools

Double-level terminal block - PTTBS 2,5-QUATTRO-PE - 3210611

Accessories

Screwdriver - SZF 1-0,6X3,5 - 1204517



Actuation tool, for ST terminal blocks, also suitable for use as a bladed screwdriver, size: 0.6 x 3.5 x 100 mm, 2-component grip, with non-slip grip

Actuation tool - ST-BW - 1207608



Actuation tool, for all 2.5 mm² - 4.0 mm² spring-cages

Terminal marking

Group marker label for terminal marking - GBS 5-25X12 - 0810588



Group marker label, snaps onto terminal center for screw, spring-cage and quick connection terminal blocks, labeled with a 25 x 12 mm label or manually with the B-STIFT, in the foot part with ZB 5

Zack marker strip - ZB 5 :UNBEDRUCKT - 1050004



Zack marker strip, Strip, white, unlabeled, can be labeled with: PLOTMARK, CMS-P1-PLOTTER, mounting type: snap into tall marker groove, for terminal block width: 5.2 mm, lettering field size: 5.1 x 10.5 mm, Number of individual labels: 10

Marker for terminal blocks - UC-TM 5 - 0818108



Marker for terminal blocks, Sheet, white, unlabeled, can be labeled with: BLUEMARK ID COLOR, BLUEMARK ID, BLUEMARK CLED, PLOTMARK, CMS-P1-PLOTTER, mounting type: snap into tall marker groove, for terminal block width: 5.2 mm, lettering field size: 10.5 x 4.6 mm, Number of individual labels: 96

Double-level terminal block - PTTBS 2,5-QUATTRO-PE - 3210611

Accessories

Marker for terminal blocks - UCT-TM 5 - 0828734



Marker for terminal blocks, Sheet, white, unlabeled, can be labeled with: TOPMARK NEO, TOPMARK LASER, BLUEMARK ID COLOR, BLUEMARK ID, BLUEMARK CLED, THERMOMARK PRIME, THERMOMARK CARD 2.0, THERMOMARK CARD, mounting type: snap into tall marker groove, for terminal block width: 5.2 mm, lettering field size: 4.6 x 10.5 mm, Number of individual labels: 72

Zack Marker strip, flat - ZBF 5:UNBEDRUCKT - 0808642



Zack Marker strip, flat, Strip, white, unlabeled, can be labeled with: PLOTMARK, CMS-P1-PLOTTER, mounting type: snap into flat marker groove, for terminal block width: 5 mm, lettering field size: 5.1 x 5.2 mm, Number of individual labels: 10

Marker for terminal blocks - UC-TMF 5 - 0818153



Marker for terminal blocks, Sheet, white, unlabeled, can be labeled with: BLUEMARK ID COLOR, BLUEMARK ID, BLUEMARK CLED, PLOTMARK, CMS-P1-PLOTTER, mounting type: snap into flat marker groove, for terminal block width: 5.2 mm, lettering field size: 4.6 x 5.1 mm, Number of individual labels: 96

Marker for terminal blocks - UCT-TMF 5 - 0828744



Marker for terminal blocks, Sheet, white, unlabeled, can be labeled with: TOPMARK NEO, TOPMARK LASER, BLUEMARK ID COLOR, BLUEMARK ID, BLUEMARK CLED, THERMOMARK PRIME, THERMOMARK CARD 2.0, THERMOMARK CARD, mounting type: snap into flat marker groove, for terminal block width: 5.2 mm, lettering field size: 4.4 x 4.7 mm, Number of individual labels: 72

Test plug terminal block

Test plugs - MPS-MT - 0201744



Test plugs, with solder connection up to 1 mm² conductor cross section, color: gray

Double-level terminal block - PTTBS 2,5-QUATTRO-PE - 3210611

Accessories

Test plugs - PS-5 - 3030983



Test plugs, Modular test plug, color: red

Test plugs - PS-5/2,3MM RD - 3038723



Test plugs, color: red

Test socket

Test adapter - PAI-4-FIX-5/6 BU - 3035975



4 mm test adapter, for terminal blocks with 5.2 mm and 6.2 mm pitch

Test adapter - PAI-4-FIX-5/6 OG - 3035974



4 mm test adapter, for terminal blocks with 5.2 mm and 6.2 mm pitch

Test adapter - PAI-4-FIX-5/6 YE - 3035977



4 mm test adapter, for terminal blocks with 5.2 mm and 6.2 mm pitch

Double-level terminal block - PTTBS 2,5-QUATTRO-PE - 3210611

Accessories

Test adapter - PAI-4-FIX-5/6 RD - 3035976



4 mm test adapter, for terminal blocks with 5.2 mm and 6.2 mm pitch

Test adapter - PAI-4-FIX-5/6 GN - 3035978



4 mm test adapter, for terminal blocks with 5.2 mm and 6.2 mm pitch

Test adapter - PAI-4-FIX-5/6 BK - 3035980



4 mm test adapter, for terminal blocks with 5.2 mm and 6.2 mm pitch

Test adapter - PAI-4-FIX-5/6 GY - 3035982



4 mm test adapter, for terminal blocks with 5.2 mm and 6.2 mm pitch

Test adapter - PAI-4-FIX-5/6 VT - 3035979



4 mm test adapter, for terminal blocks with 5.2 mm and 6.2 mm pitch

Double-level terminal block - PTTBS 2,5-QUATTRO-PE - 3210611

Accessories

Test adapter - PAI-4-FIX-5/6 BN - 3035981



4 mm test adapter, for terminal blocks with 5.2 mm and 6.2 mm pitch

Test adapter - PAI-4-FIX-5/6 WH - 3035983



4 mm test adapter, for terminal blocks with 5.2 mm and 6.2 mm pitch

Warning label printed

Warning label - WS PT 2,5 - 1029026



Warning label, yellow/black, labeled: Lightning flash, mounting type: plug in, for terminal block width: 5.2 mm

Warning label - WS-DIO PT 2,5 - 1029037



Warning label, yellow/black, labeled: Diode, mounting type: plug in, for terminal block width: 5.2 mm

Phoenix Contact 2020 © - all rights reserved
<http://www.phoenixcontact.com>

PHOENIX CONTACT GmbH & Co. KG
Flachsmarktstr. 8
32825 Blomberg
Germany
Tel. +49 5235 300
Fax +49 5235 3 41200
<http://www.phoenixcontact.com>

X-ON Electronics

Largest Supplier of Electrical and Electronic Components

Click to view similar products for [DIN Rail Terminal Blocks](#) category:

Click to view products by [Phoenix Contact](#) manufacturer:

Other Similar products are found below :

[00110420202](#) [8WA1011-1BH23](#) [8WA1011-1EF20](#) [91.010](#) [9102100000](#) [91.040](#) [9123140000](#) [9123140001](#) [RBO 5-T-B-HEX](#) [1333564](#) [DP25-GY-ND](#) [1431306](#) [1433306](#) [90.070](#) [91.020](#) [912314](#) [260-301_NR](#) [2757571](#) [280-331](#) [280-560](#) [280-564](#) [281-611/281-542](#) [281-673/281-411](#) [281-994](#) [283-317](#) [283-607](#) [2909798](#) [264-724](#) [264-726](#) [280-530](#) [280-555](#) [280-619](#) [281-610](#) [281-622/281-417](#) [284-317](#) [284-601](#) [2907033](#) [3048496](#) [5542152](#) [35956](#) [USK 10](#) [102510](#) [1025100000](#) [5520682](#) [5607102](#) [EMH 25-ZE30](#) [591620-2](#) [UM 45-SEFE M.NUT BK](#) [1-591651-1](#) [8671050000](#)