

## Plug - PP 2,5/ 1-M - 3211274

Please be informed that the data shown in this PDF Document is generated from our Online Catalog. Please find the complete data in the user's documentation. Our General Terms of Use for Downloads are valid (<http://phoenixcontact.com/download>)



Plug, center element, nom. voltage: 800 V, nominal current: 24 A, connection method: Push-in connection, number of connections: 1, number of positions: 1, cross section: 0.14 mm<sup>2</sup> - 4 mm<sup>2</sup>, AWG: 26 - 12, width: 5.2 mm, height: 41.2 mm, color: gray

### Your advantages

- The Push-in technology COMBI plugs for self-assembly provide solutions that users can implement themselves



### Key Commercial Data

Packing unit	50 pc
Minimum order quantity	50 pc
GTIN	
GTIN	4055626285276

### Technical data

#### General

Number of positions	1
Number of levels	1
Number of connections	1
Potentials	1
Nominal cross section	2.5 mm <sup>2</sup>
Color	gray
Insulating material	PA
Flammability rating according to UL 94	V0
Area of application	Machine building Plant engineering
Assembly instructions	Use of a parallel pressing tool is recommended for easy latching of the COMBI connector and coupling elements for self-assembly
Rated surge voltage	6 kV
Degree of pollution	3

# Plug - PP 2,5/ 1-M - 3211274

## Technical data

### General

Overvoltage category	III
Insulating material group	I
Maximum power dissipation for nominal condition	0.77 W
Maximum load current	24 A (with 4 mm <sup>2</sup> conductor cross section)
Nominal current I <sub>N</sub>	24 A
Nominal voltage U <sub>N</sub>	800 V
Open side panel	No

### Dimensions

Width	5.2 mm
Length	16 mm
Height	41.2 mm
	25.6 mm
Pitch	5.2 mm

### Connection data

Connection	1 level
Connection method	Push-in connection
Stripping length	8 mm ... 10 mm
Connection in acc. with standard	IEC 61984
Conductor cross section solid min.	0.14 mm <sup>2</sup>
Conductor cross section solid max.	4 mm <sup>2</sup>
Conductor cross section AWG min.	26
Conductor cross section AWG max.	12
Conductor cross section flexible min.	0.14 mm <sup>2</sup>
Conductor cross section flexible max.	2.5 mm <sup>2</sup>
Min. AWG conductor cross section, flexible	26
Max. AWG conductor cross section, flexible	14
Conductor cross section flexible, with ferrule without plastic sleeve min.	0.14 mm <sup>2</sup>
Conductor cross section flexible, with ferrule without plastic sleeve max.	2.5 mm <sup>2</sup>
Conductor cross section flexible, with ferrule with plastic sleeve min.	0.14 mm <sup>2</sup>
Conductor cross section flexible, with ferrule with plastic sleeve max.	2.5 mm <sup>2</sup>
Two conductors with the same cross section, flexible, with TWIN ferrules, with plastic sleeve, maximum	0.5 mm <sup>2</sup>
Connection cross sections directly pluggable	0.34 mm <sup>2</sup> 4 mm <sup>2</sup>
Conductor cross section solid min.	0.34 mm <sup>2</sup>
Conductor cross section solid max.	4 mm <sup>2</sup>
Conductor cross section flexible, with ferrule without plastic sleeve min.	0.34 mm <sup>2</sup>
Conductor cross section flexible, with ferrule without plastic sleeve max.	2.5 mm <sup>2</sup>
Conductor cross section flexible, with ferrule with plastic sleeve min.	0.34 mm <sup>2</sup>
Conductor cross section flexible, with ferrule with plastic sleeve max.	2.5 mm <sup>2</sup>
Internal cylindrical gage	A3

# Plug - PP 2,5/ 1-M - 3211274

## Technical data

### Standards and Regulations

Connection in acc. with standard	IEC 61984
Flammability rating according to UL 94	V0

### Environmental Product Compliance

China RoHS	Environmentally friendly use period: unlimited = EFUP-e
	No hazardous substances above threshold values

## Drawings

Schematic diagram

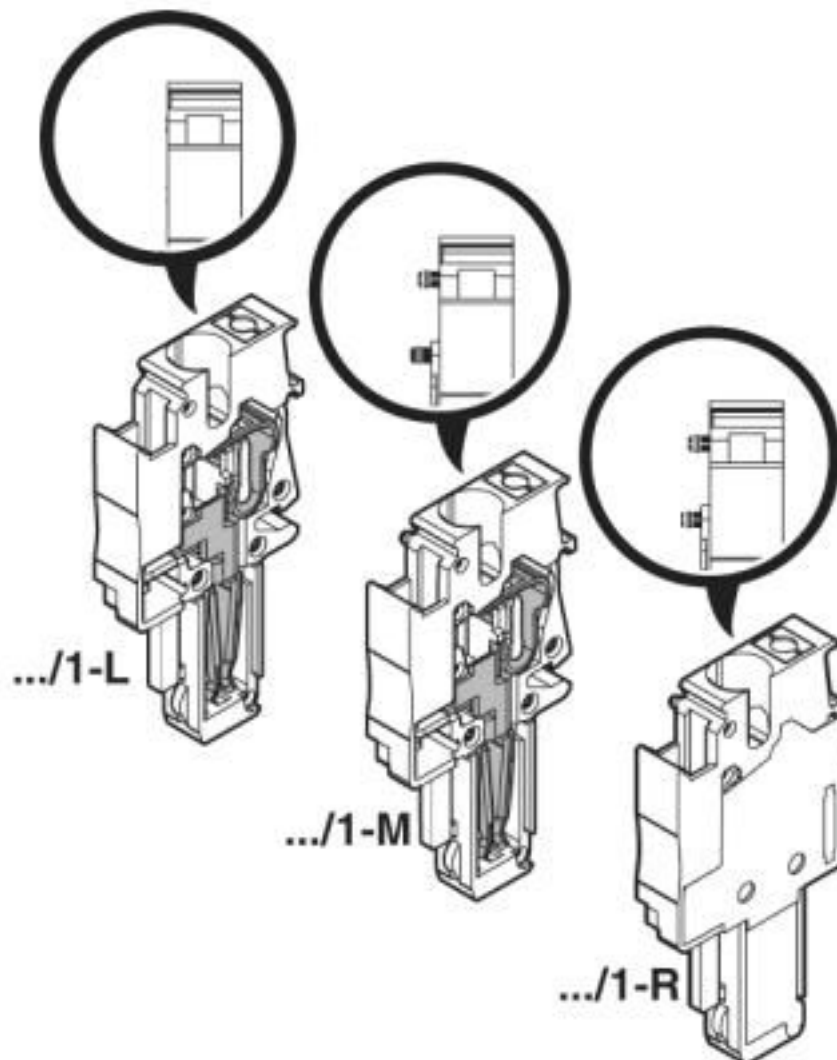

# Plug - PP 2,5/ 1-M - 3211274

Circuit diagram



## Classifications

### eCl@ss

eCl@ss 10.0.1	27141151
eCl@ss 4.0	272607xx
eCl@ss 4.1	27260701
eCl@ss 5.0	27260701
eCl@ss 5.1	27260701
eCl@ss 6.0	27141100
eCl@ss 7.0	27141151
eCl@ss 8.0	27141151
eCl@ss 9.0	27141151

### ETIM

ETIM 2.0	EC000897
ETIM 3.0	EC000897
ETIM 4.0	EC002021
ETIM 5.0	EC002021
ETIM 6.0	EC002021
ETIM 7.0	EC002021

### UNSPSC

UNSPSC 6.01	30211802
UNSPSC 7.0901	39121402
UNSPSC 11	39121402
UNSPSC 12.01	39121402
UNSPSC 13.2	39121402
UNSPSC 18.0	39121402
UNSPSC 19.0	39121402
UNSPSC 20.0	39121402
UNSPSC 21.0	39121402

## Approvals

### Approvals

Approvals

CSA / UL Recognized / cUL Recognized / EAC / EAC / cULus Recognized

# Plug - PP 2,5/ 1-M - 3211274

## Approvals

Ex Approvals

### Approval details

CSA		<a href="http://www.csagroup.org/services-industries/product-listing/">http://www.csagroup.org/services-industries/product-listing/</a>	13631
		B	C
Nominal voltage UN		600 V	600 V
Nominal current IN		20 A	20 A
mm <sup>2</sup> /AWG/kcmil		26-12	26-12

UL Recognized		<a href="http://database.ul.com/cgi-bin/XYV/template/LISEXT/1FRAME/index.htm">http://database.ul.com/cgi-bin/XYV/template/LISEXT/1FRAME/index.htm</a>	FILE E 60425
		B	C
Nominal voltage UN		600 V	600 V
Nominal current IN		20 A	20 A
mm <sup>2</sup> /AWG/kcmil		26-12	26-12

cUL Recognized		<a href="http://database.ul.com/cgi-bin/XYV/template/LISEXT/1FRAME/index.htm">http://database.ul.com/cgi-bin/XYV/template/LISEXT/1FRAME/index.htm</a>	FILE E 60425
		B	C
Nominal voltage UN		600 V	600 V
Nominal current IN		20 A	20 A
mm <sup>2</sup> /AWG/kcmil		26-12	26-12

EAC			RU C- DE.A*30.B.01742
-----	---	--	--------------------------

EAC			RU C- DE.BL08.B.00511
-----	---	--	--------------------------

cULus Recognized			
------------------	---	--	--

## Plug - PP 2,5/ 1-M - 3211274

### Accessories

#### Accessories

##### End cover

Flange cover - DF-SP-H 2,5 - 3209824



Flange cover, length: 35.8 mm, width: 4.5 mm, height: 24.7 mm, color: gray

---

### Insulating sleeve

Insulating sleeve - MPS-IH RD - 0201676

Insulating sleeve, color: red



---

### Labeled terminal marker

Zack Marker strip, flat - ZBF 5 CUS - 0825025



Zack Marker strip, flat, can be ordered: Strip, white, labeled according to customer specifications, mounting type: snap into flat marker groove, for terminal block width: 5 mm, lettering field size: 5.15 x 5.15 mm, Number of individual labels: 10

---

Zack Marker strip, flat - ZBF 5,LGS:FORTL.ZAHLEN - 0808671



Zack Marker strip, flat, Strip, white, labeled, printed horizontally: consecutive numbers 1 ... 10, 11 ... 20, etc. up to 491 ... 500, mounting type: snap into flat marker groove, for terminal block width: 5 mm, lettering field size: 5.15 x 5.15 mm, Number of individual labels: 10

---

Zack Marker strip, flat - ZBF 5,QR:FORTL.ZAHLEN - 0808697



Zack Marker strip, flat, Strip, white, labeled, Printed vertically: consecutive numbers 1 ... 10, 11 ... 20, etc. up to 91 ... 100, mounting type: snap into flat marker groove, for terminal block width: 5 mm, lettering field size: 5.15 x 5.15 mm, Number of individual labels: 10

## Plug - PP 2,5/ 1-M - 3211274

### Accessories

Zack Marker strip, flat - ZBF 5,LGS:GERADE ZAHLEN - 0810821



Zack Marker strip, flat, Strip, white, labeled, printed horizontally: consecutive numbers 2 ... 20, 22 ... 40, etc. up to 82 ... 100, mounting type: snap into flat marker groove, for terminal block width: 5 mm, lettering field size: 5.15 x 5.15 mm, Number of individual labels: 10

Zack Marker strip, flat - ZBF 5,LGS:UNGERADE ZAHLEN - 0810863



Zack Marker strip, flat, Strip, white, labeled, printed horizontally: Odd numbers 1 - 19, 21 - 39, etc. up to 81 - 99, mounting type: snap into flat marker groove, for terminal block width: 5 mm, lettering field size: 5.15 x 5.15 mm, Number of individual labels: 10

Marker for terminal blocks - UC-TMF 5 CUS - 0824638



Marker for terminal blocks, can be ordered: by sheet, white, labeled according to customer specifications, mounting type: snap into flat marker groove, for terminal block width: 5.2 mm, lettering field size: 4.6 x 5.1 mm, Number of individual labels: 96

Marker for terminal blocks - UCT-TMF 5 CUS - 0829658



Marker for terminal blocks, can be ordered: by sheet, white, labeled according to customer specifications, mounting type: snap into flat marker groove, for terminal block width: 5.2 mm, lettering field size: 4.4 x 4.7 mm, Number of individual labels: 72

### Mounting material

Latching - PRZ - 3040614



Latching, length: 63.6 mm, width: 9.7 mm, number of positions: 2, color: orange

## Plug - PP 2,5/ 1-M - 3211274

### Accessories

Latching - PR - 3040559



Latching, length: 29.8 mm, width: 4.4 mm, number of positions: 1, color: orange

---

### Strain relief

Strain relief - PZ/2 - 3040627



Strain relief, length: 48.7 mm, width: 9.3 mm, number of positions: 2, color: black

---

### Terminal marking

Zack Marker strip, flat - ZBF 5:UNBEDRUCKT - 0808642



Zack Marker strip, flat, Strip, white, unlabeled, can be labeled with: PLOTMARK, CMS-P1-PLOTTER, mounting type: snap into flat marker groove, for terminal block width: 5 mm, lettering field size: 5.1 x 5.2 mm, Number of individual labels: 10

---

Marker for terminal blocks - UC-TMF 5 - 0818153



Marker for terminal blocks, Sheet, white, unlabeled, can be labeled with: BLUEMARK ID COLOR, BLUEMARK ID, BLUEMARK CLED, PLOTMARK, CMS-P1-PLOTTER, mounting type: snap into flat marker groove, for terminal block width: 5.2 mm, lettering field size: 4.6 x 5.1 mm, Number of individual labels: 96

---

Marker for terminal blocks - UCT-TMF 5 - 0828744



Marker for terminal blocks, Sheet, white, unlabeled, can be labeled with: TOPMARK NEO, TOPMARK LASER, BLUEMARK ID COLOR, BLUEMARK ID, BLUEMARK CLED, THERMOMARK PRIME, THERMOMARK CARD 2.0, THERMOMARK CARD, mounting type: snap into flat marker groove, for terminal block width: 5.2 mm, lettering field size: 4.4 x 4.7 mm, Number of individual labels: 72

---

### Test plug terminal block



## Plug - PP 2,5/ 1-M - 3211274

### Accessories

Test plugs - MPS-MT - 0201744



Test plugs, with solder connection up to 1 mm<sup>2</sup> conductor cross section, color: gray

---

Phoenix Contact 2020 © - all rights reserved  
<http://www.phoenixcontact.com>

PHOENIX CONTACT GmbH & Co. KG  
Flachsmarktstr. 8  
32825 Blomberg  
Germany  
Tel. +49 5235 300  
Fax +49 5235 3 41200  
<http://www.phoenixcontact.com>

## X-ON Electronics

Largest Supplier of Electrical and Electronic Components

*Click to view similar products for [Pluggable Terminal Blocks](#) category:*

*Click to view products by [Phoenix Contact](#) manufacturer:*

Other Similar products are found below :

[57.510.0053](#) [MC 1.5/ 6-ST-3.5 GY AU](#) [734-104](#) [734-302](#) [8-141-P](#) [8426620000](#) [860505](#) [860810](#) [GBPACX-12](#) [93.731.4953.0](#) [PV05-5,08-K](#)  
[PVP02-5,00](#) [PVP03-3,50](#) [PVP04-3,50](#) [PVS02-5,00](#) [1-1986160-3](#) [1377680000](#) [1531000000](#) [1546228-5](#) [ELFH16150](#) [ELFP03110](#)  
[ELFP10210](#) [ELFT06250](#) [ELVP03100](#) [1700101](#) [1700410](#) [1700425](#) [1702246](#) [1705229](#) [1710175](#) [1714537](#) [1717806](#) [1719600](#) [1728941](#)  
[1734692](#) [1734795](#) [1736036](#) [1740194](#) [1740291](#) [1740628](#) [1740990](#) [1746952](#) [1750207](#) [1752441](#) [1752865](#) [1754115](#) [1754144](#) [1756913](#)  
[1760051](#) [1760336](#)