

Ring cable lug - C-RC 35/M8 DIN - 3240106

Please be informed that the data shown in this PDF Document is generated from our Online Catalog. Please find the complete data in the user's documentation. Our General Terms of Use for Downloads are valid (<http://phoenixcontact.com/download>)



Ring cable lug, non-insulated, 35 mm², M8

Your advantages

- ✓ The CRIMPFOX-RC... tools from our CRIMPFOX range of crimping pliers are available for optimum crimping
- ✓ The ring cable lugs without plastic sleeve are made from high-quality tin-plated electrolytic copper for maximum protection against corrosion
- ✓ The hard-soldered press zone enables maximum conductor pull-out values to be achieved

Key Commercial Data

Packing unit	100 pc
Minimum order quantity	100 pc
GTIN	 4 046356 453233
GTIN	4046356453233

Technical data

Dimensions

Length (b)	34 mm
Width (a)	16 mm
Maximum stripping length	15 mm
Length of insulation sleeve (c)	12 mm
Inner dimension of the insulating collar (d)	9 mm
Distance between the center and the insulation sleeve (e)	14 mm
Inner diameter (f)	8.4 mm
Material thickness (g)	1.6 mm

Ambient conditions

Ambient temperature (operation)	110 °C
---------------------------------	--------

General

Ring cable lug - C-RC 35/M8 DIN - 3240106

Technical data

General

Color	silver
Stripping length	15 mm
Material	Copper
Coating	tin-plated

Standards and Regulations

Design according to standard	DIN 46234
------------------------------	-----------

Environmental Product Compliance

China RoHS	Environmentally friendly use period: unlimited = EFUP-e
	No hazardous substances above threshold values

Drawings

Dimensional drawing

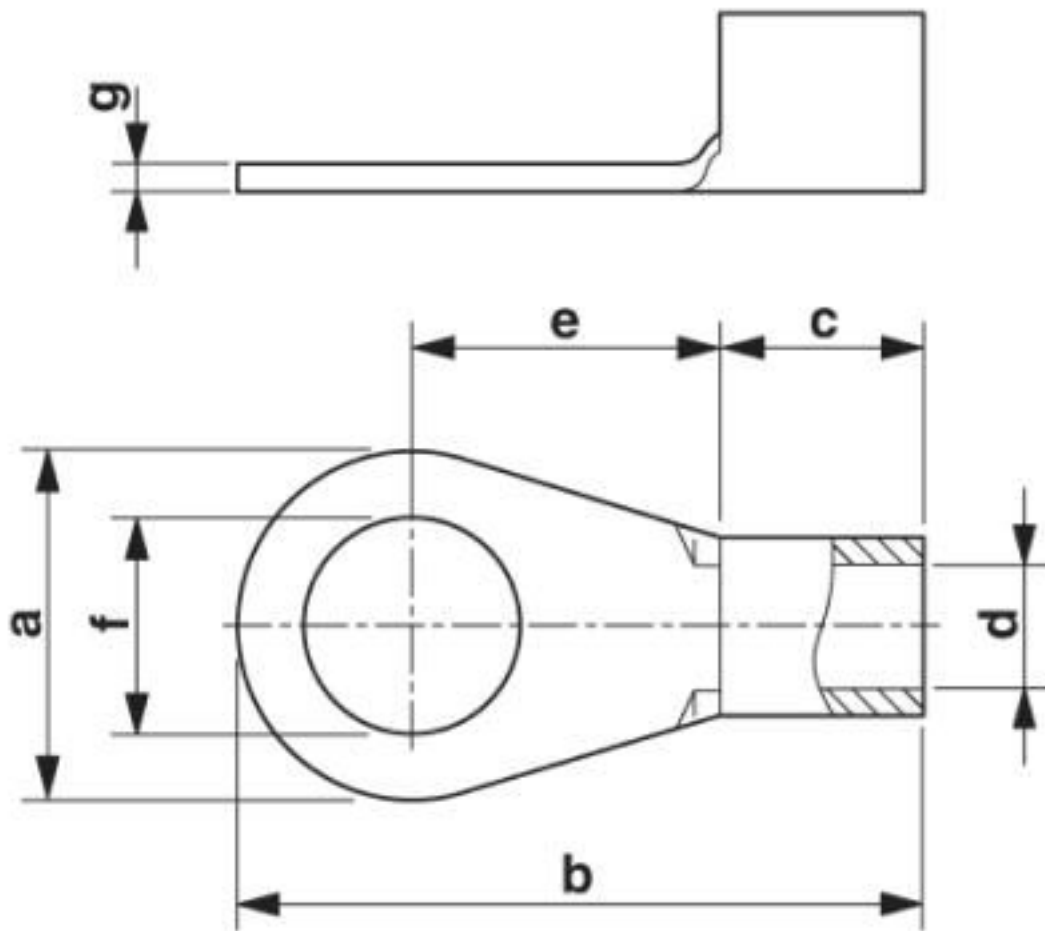

Ring cable lug - C-RC 35/M8 DIN - 3240106

Classifications

eCl@ss

eCl@ss 10.0.1	27400204
eCl@ss 4.0	27060700
eCl@ss 4.1	27060700
eCl@ss 5.0	27400200
eCl@ss 5.1	27400200
eCl@ss 6.0	27400200
eCl@ss 7.0	27400203
eCl@ss 8.0	27400204
eCl@ss 9.0	27400204

ETIM

ETIM 2.0	EC000005
ETIM 3.0	EC000005
ETIM 4.0	EC001052
ETIM 5.0	EC001052
ETIM 6.0	EC001052
ETIM 7.0	EC001052

UNSPSC

UNSPSC 6.01	30211923
UNSPSC 7.0901	27121703
UNSPSC 11	27121703
UNSPSC 12.01	27121703
UNSPSC 13.2	27121707
UNSPSC 18.0	27121707
UNSPSC 19.0	27121707
UNSPSC 20.0	27121707
UNSPSC 21.0	27121707

Approvals

Approvals

Approvals

EAC

Ex Approvals

Approval details

Ring cable lug - C-RC 35/M8 DIN - 3240106

Approvals

EAC



EAC-Zulassung

Phoenix Contact 2020 © - all rights reserved
<http://www.phoenixcontact.com>

PHOENIX CONTACT GmbH & Co. KG
Flachsmarktstr. 8
32825 Blomberg
Germany
Tel. +49 5235 300
Fax +49 5235 3 41200
<http://www.phoenixcontact.com>

X-ON Electronics

Largest Supplier of Electrical and Electronic Components

Click to view similar products for [Terminals](#) category:

Click to view products by [Phoenix Contact](#) manufacturer:

Other Similar products are found below :

[00-054007-01074-6](#) [00-054007-70206-1](#) [00-054007-70210-8](#) [00-054007-70217-7](#) [00-054007-70226-9](#) [00-054007-70228-3](#) [00-054007-70248-1](#) [00-054007-70256-6](#) [00-054007-70301-3](#) [00-054007-70316-7](#) [0-0320562-0](#) [00-054007-49560-4](#) [00-054007-70209-2](#) [00-054007-70225-2](#) [00-054007-70227-6](#) [00-054007-70231-3](#) [00-054007-70241-2](#) [00-054007-70242-9](#) [00-054007-70244-3](#) [00-054007-70246-7](#) [00-054007-70263-4](#) [00-054007-70288-7](#) [00-054007-70290-0](#) [00-054007-70300-6](#) [00-054007-70304-4](#) [01-2065-1-0216](#) [01-2900-1-04412](#) [00581P0075](#) [600TS-10](#) [60205-1](#) [604200-1](#) [605601-1](#) [60598-1-CUT-TAPE](#) [61314-6-C](#) [61810-3](#) [61-S](#) [61-SN](#) [626-0194](#) [62-NBM-A](#) [62-SN](#) [62-SP](#) [63-S](#) [640179-1](#) [M55155/059I03](#) [M55155/079C01](#) [M55155/099H02](#) [M55155/109H01](#) [M55155/109H02](#) [M55155/12XH05](#) [M55155/16XH02](#)