

Cable clamp - WCC 38 - 3240258

Please be informed that the data shown in this PDF Document is generated from our Online Catalog. Please find the complete data in the user's documentation. Our General Terms of Use for Downloads are valid (<http://phoenixcontact.com/download>)



Cable clamp, for DIN rails

Your advantages

- ✓ The halogen-free plastic troughs have been designed to be perfectly secure while simultaneously protecting the conductors
- ✓ Individual or bundled cables with a diameter of up to 38 mm can be installed safely and easily
- ✓ The cable clamps provide strain relief

Key Commercial Data

Packing unit	25 pc
GTIN	
GTIN	4046356464505

Technical data

Dimensions

Cable diameter	34 mm ... 38 mm
----------------	-----------------

General

Material	Steel
Coating	galvanized

Environmental Product Compliance

China RoHS	Environmentally friendly use period: unlimited = EFUP-e
	No hazardous substances above threshold values

Drawings

Cable clamp - WCC 38 - 3240258

Dimensional drawing

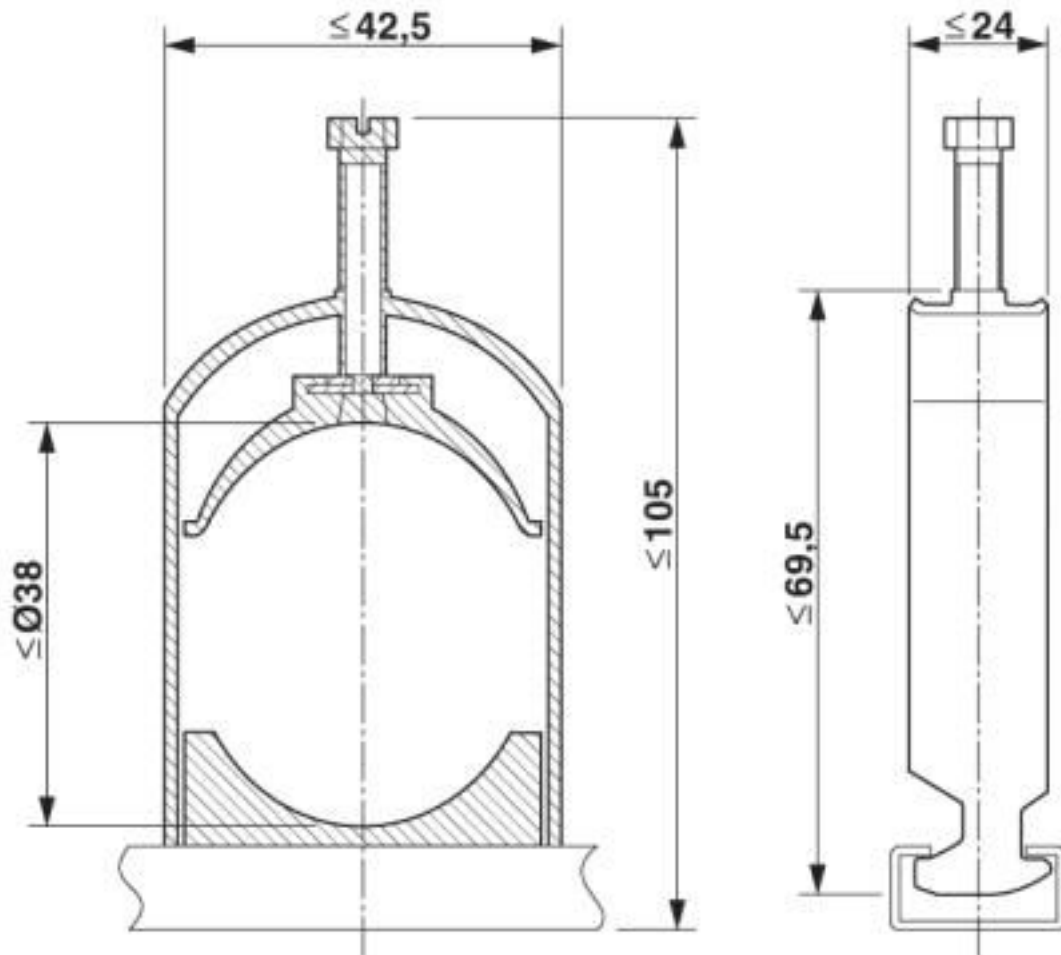

Classifications

eCl@ss

eCl@ss 10.0.1	23159090
eCl@ss 4.0	23140300
eCl@ss 4.1	23140300
eCl@ss 5.0	23140300
eCl@ss 5.1	23140300
eCl@ss 6.0	23140300
eCl@ss 7.0	23140390
eCl@ss 8.0	23140390
eCl@ss 9.0	23159090

ETIM

ETIM 2.0	EC000897
ETIM 3.0	EC000897

Cable clamp - WCC 38 - 3240258

Classifications

ETIM

ETIM 4.0	EC000441
ETIM 5.0	EC000454
ETIM 6.0	EC000454
ETIM 7.0	EC000454

UNSPSC

UNSPSC 6.01	30211811
UNSPSC 7.0901	39121410
UNSPSC 11	39121410
UNSPSC 12.01	39121410
UNSPSC 13.2	31162906
UNSPSC 18.0	31162906
UNSPSC 19.0	31162906
UNSPSC 20.0	31162906
UNSPSC 21.0	31162906

Accessories

Accessories

DIN rail

DIN rail perforated - NS 30/15 PERF.2000MM - 3240262



DIN rail perforated, C profile, width: 30 mm, height: 15 mm, similar to EN 60715, material: Steel, galvanized, length: 2000 mm

Phoenix Contact 2020 © - all rights reserved
<http://www.phoenixcontact.com>

PHOENIX CONTACT GmbH & Co. KG
Flachsmarktstr. 8
32825 Blomberg
Germany
Tel. +49 5235 300
Fax +49 5235 3 41200
<http://www.phoenixcontact.com>

X-ON Electronics

Largest Supplier of Electrical and Electronic Components

Click to view similar products for [Cable Mounting & Accessories](#) category:

Click to view products by [Phoenix Contact](#) manufacturer:

Other Similar products are found below :

[582603-1](#) [009333-000](#) [727844N003](#) [747](#) [809090N001](#) [843188-000](#) [8666](#) [967279N002](#) [DB-11](#) [1300840039](#) [1300900096](#) [1301800416](#)
[1302264450](#) [1300830184](#) [1300830729](#) [1300900039](#) [1301580036](#) [1301850553](#) [1301860939](#) [1302000074](#) [1302261315](#) [1302264431](#)
[1337706-2](#) [APA18-AK](#) [1724](#) [1-787307-1](#) [185491N001](#) [1868](#) [HP-6N](#) [C-202-C](#) [202C221-13-0](#) [CA7308-000](#) [8S23-75FR-CS8184](#) [2684](#) [9648](#)
[3089](#) [988382-000](#) [A72821-000](#) [AA401](#) [173506-000](#) [1823](#) [202C292-13-0](#) [202C302-13-0](#) [2109](#) [300625](#) [3330](#) [3412](#) [356247-1](#) [M9142](#)
[M9143](#)