

PCB terminal block - BC-500X14- 2 BK - 5452259

Please be informed that the data shown in this PDF Document is generated from our Online Catalog. Please find the complete data in the user's documentation. Our General Terms of Use for Downloads are valid (<http://phoenixcontact.com/download>)

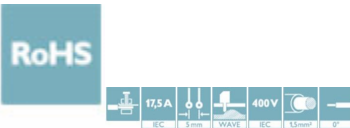

PCB terminal block, nominal current: 17.5 A, rated voltage (III/2): 400 V, nominal cross section: 1.5 mm², pitch: 5 mm, number of positions: 2, connection method: Screw connection with tension sleeve, mounting: Wave soldering, conductor/PCB connection direction: 0 °, color: black, Pin layout: Linear pinning, Solder pin [P]: 3.5 mm. The article can be aligned to create different nos. of positions!



Key Commercial Data

Packing unit	1 pc
Minimum order quantity	100 pc
GTIN	 4 046356 853224
GTIN	4046356853224
Weight per Piece (excluding packing)	2.800 g
Custom tariff number	85369010
Country of origin	China

Technical data

Dimensions

Length [l]	9.8 mm
Pitch	5 mm
Dimension a	5 mm
Width [w]	10 mm
Installed height	13.8 mm
Height [h]	17.3 mm
Solder pin [P]	3.5 mm
Hole diameter	1.3 mm

General

Range of articles	BC-X14
-------------------	--------

PCB terminal block - BC-500X14- 2 BK - 5452259

Technical data

General

Rated surge voltage (III/3)	4 kV
Rated surge voltage (III/2)	4 kV
Rated surge voltage (II/2)	4 kV
Rated voltage (III/3)	250 V
Rated voltage (III/2)	400 V
Rated voltage (II/2)	630 V
Connection in acc. with standard	EN-VDE
Nominal current I_N	17.5 A
Nominal cross section	1.5 mm ²
Insulating material	PA
Flammability rating according to UL 94	V0
Internal cylindrical gage	A1
Stripping length	7 mm
Number of positions	2
Screw thread	M3
Tightening torque, min	0.5 Nm
Tightening torque max	0.6 Nm

Connection data

Conductor cross section solid min.	0.14 mm ²
Conductor cross section solid max.	2.5 mm ²
Conductor cross section flexible min.	0.14 mm ²
Conductor cross section flexible max.	1.5 mm ²
Conductor cross section flexible, with ferrule without plastic sleeve min.	0.25 mm ²
Conductor cross section flexible, with ferrule without plastic sleeve max.	1.5 mm ²
Conductor cross section flexible, with ferrule with plastic sleeve min.	0.25 mm ²
Conductor cross section flexible, with ferrule with plastic sleeve max.	1.5 mm ²
Conductor cross section AWG min.	26
Conductor cross section AWG max.	14
2 conductors with same cross section, solid min.	0.14 mm ²
2 conductors with same cross section, solid max.	1 mm ²
2 conductors with same cross section, stranded min.	0.14 mm ²
2 conductors with same cross section, stranded max.	0.75 mm ²
Two conductors with the same cross section stranded, with ferrule and without plastic sleeve, minimum	0.25 mm ²
Two conductors with the same cross section stranded, with ferrule and without plastic sleeve, maximum	0.5 mm ²
Two conductors with the same cross section, flexible, with TWIN ferrules, with plastic sleeve, minimum	0.5 mm ²

PCB terminal block - BC-500X14- 2 BK - 5452259

Technical data

Connection data

Two conductors with the same cross section, flexible, with TWIN ferrules, with plastic sleeve, maximum	1 mm ²
--	-------------------

Standards and Regulations

Connection in acc. with standard	EN-VDE
	CUL
Flammability rating according to UL 94	V0

Environmental Product Compliance

REACH SVHC	Lead 7439-92-1
China RoHS	Environmentally Friendly Use Period = 50 years
	For details about hazardous substances go to tab "Downloads", Category "Manufacturer's declaration"

Drawings

PCB terminal block - BC-500X14- 2 BK - 5452259

Drilling diagram

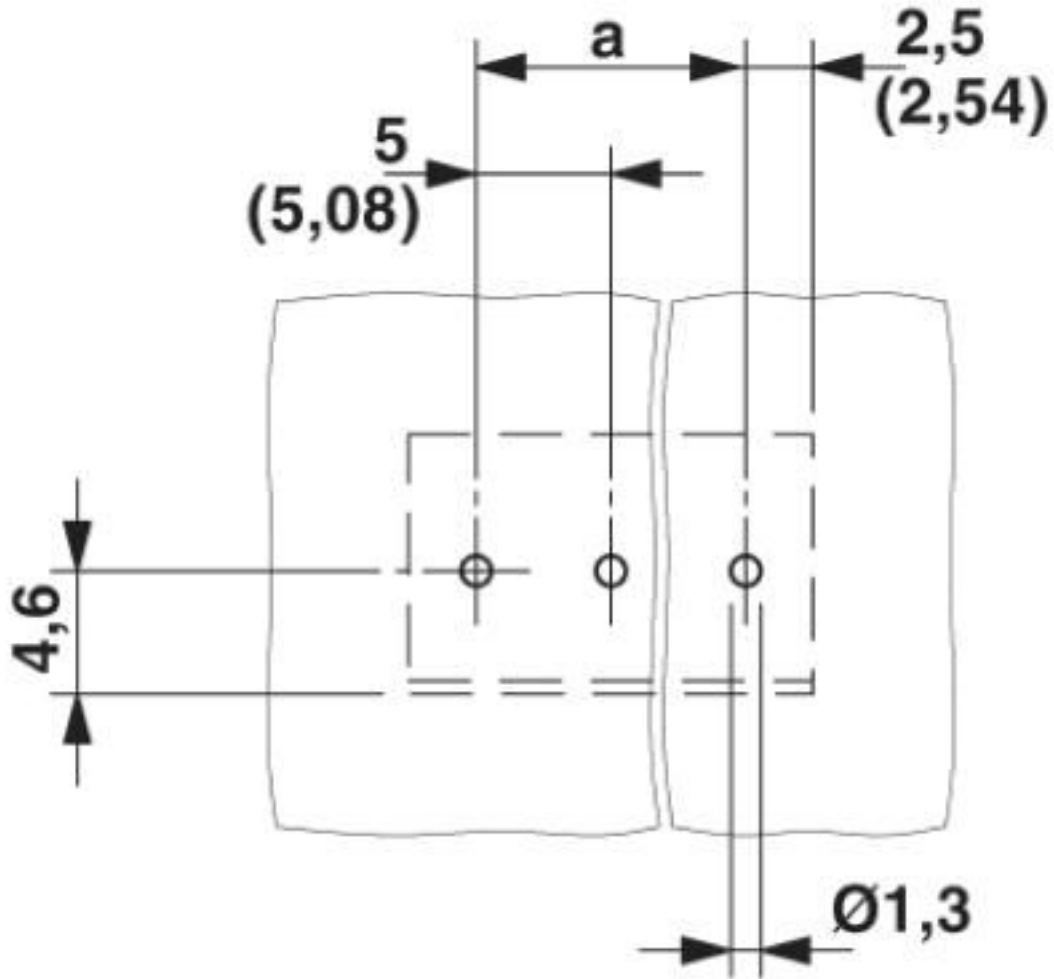

PCB terminal block - BC-500X14- 2 BK - 5452259

Dimensional drawing

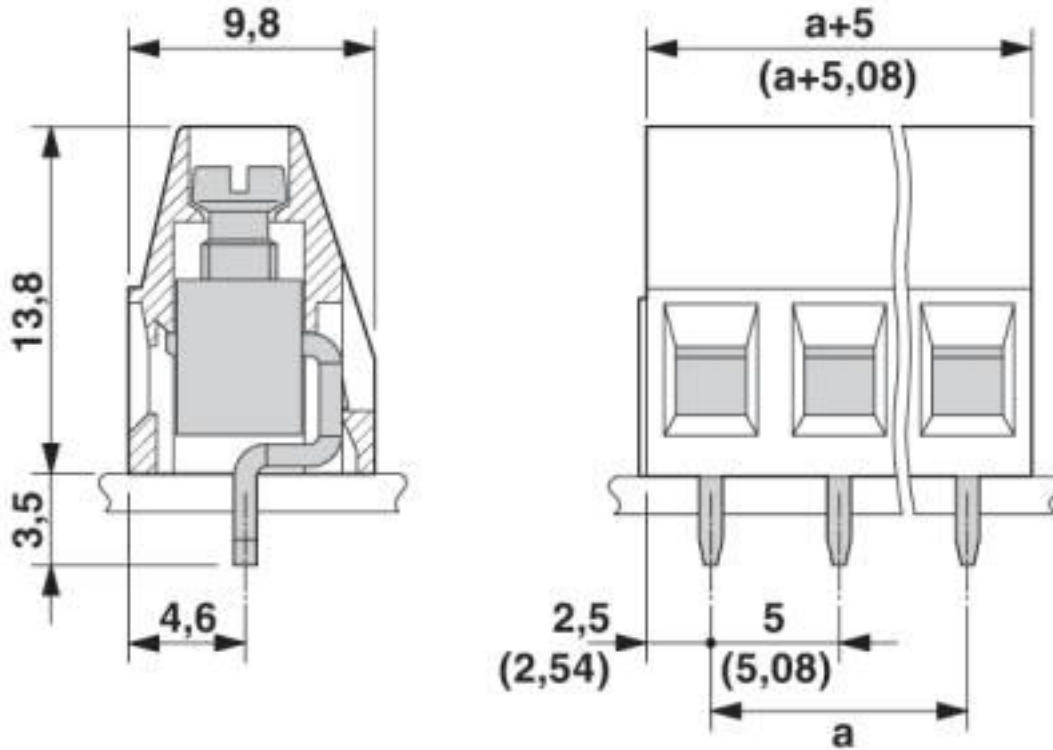

Classifications

eCl@ss

eCl@ss 10.0.1	27440401
eCl@ss 4.0	27141100
eCl@ss 4.1	27141100
eCl@ss 5.0	27141100
eCl@ss 5.1	27261100
eCl@ss 6.0	27261100
eCl@ss 7.0	27440401
eCl@ss 8.0	27440401
eCl@ss 9.0	27440401

ETIM

ETIM 3.0	EC001121
ETIM 4.0	EC002643
ETIM 5.0	EC002643
ETIM 6.0	EC002643

PCB terminal block - BC-500X14- 2 BK - 5452259

Classifications

ETIM

ETIM 7.0	EC002643
----------	----------

UNSPSC

UNSPSC 6.01	30211801
UNSPSC 7.0901	39121432
UNSPSC 11	39121432
UNSPSC 12.01	39121409
UNSPSC 13.2	39121432
UNSPSC 18.0	39121432
UNSPSC 19.0	39121432
UNSPSC 20.0	39121432
UNSPSC 21.0	39121432

Approvals

Approvals

Approvals

IECEE CB Scheme / VDE Zeichengenehmigung / cULus Recognized / EAC

Ex Approvals

Approval details

IECEE CB Scheme		http://www.iecee.org/	DE1-58998
Nominal voltage UN	400 V		
Nominal current IN	17.5 A		
mm ² /AWG/kcmil	0.14-2.5		

VDE Zeichengenehmigung		http://www2.vde.com/de/Institut/Online-Service/VDE-gepruefteProdukte/Seiten/Online-Suche.aspx	40042618
Nominal voltage UN	400 V		

PCB terminal block - BC-500X14- 2 BK - 5452259

Approvals

Nominal current I _N	17.5 A
mm ² /AWG/kcmil	0.14-1.5

cULus Recognized		http://database.ul.com/cgi-bin/XYV/template/LISEXT/1FRAME/index.htm	E60425-20071007
	B	D	
Nominal voltage U _N	300 V	150 V	
Nominal current I _N	15 A	15 A	
mm ² /AWG/kcmil	30-14	30-14	

EAC		B.01687
-----	---	---------

Accessories

Accessories

Labeled terminal marker

Marker card - SK 5/3,8:FORTL.ZAHLEN - 0804183



Marker card, Card, white, labeled, horizontal: consecutive numbers 1 ... 10, 11 ... 20, etc. up to 91 ... (99)100, mounting type: adhesive, for terminal block width: 5 mm, lettering field size: 5 x 3.8 mm

Screwdriver tools

Screwdriver - SZS 0,6X3,5 - 1205053



Actuation tool, for ST terminal blocks, insulated, also suitable for use as a bladed screwdriver, size: 0.6 x 3.5 x 100 mm, 2-component grip, with non-slip grip

X-ON Electronics

Largest Supplier of Electrical and Electronic Components

Click to view similar products for [Fixed Terminal Blocks](#) category:

Click to view products by [Phoenix Contact](#) manufacturer:

Other Similar products are found below :

[00175550202](#) [MBE-1512](#) [MBE-1520](#) [MBE-154](#) [MBE-156](#) [MBES-1510](#) [MBES-153](#) [MBES-156](#) [MH-2512](#) [MHE-132](#) [MHE-133](#) [MHE-163](#)
[MI-254 \(35\)](#) [MI-272](#) [8739](#) [880507](#) [880508](#) [MPT-275](#) [1546551-6](#) [ELM023100](#) [ELM10110G](#) [ELVD12100](#) [BA311TU](#) [BA411SU](#) [MV-152](#)
[MV-253/NCNOC](#) [MV-254-D](#) [MV-255](#) [MV-462](#) [MV-472](#) [MV-493](#) [MVE-252](#) [MVE-253](#) [MVE-258](#) [MVE-273](#) [MVEB-153](#) [1700096](#)
[1702246](#) [1705142](#) [1712417](#) [1713020](#) [1713088](#) [1776118-2](#) [1790852](#) [1-796689-8](#) [1-796692-6](#) [1800001](#) [1800114](#) [1823215](#) [1838462](#)