

Printed-circuit board connector - BCP-381F- 3 BK - 5452531

Please be informed that the data shown in this PDF Document is generated from our Online Catalog. Please find the complete data in the user's documentation. Our General Terms of Use for Downloads are valid (<http://phoenixcontact.com/download>)



PCB connector, nominal current: 8 A, rated voltage (III/2): 160 V, nominal cross section: 1.5 mm², number of positions: 3, pitch: 3.81 mm, connection method: Screw connection with tension sleeve, color: black, contact surface: Tin

The figure shows a 5-pos. version of the product in gray

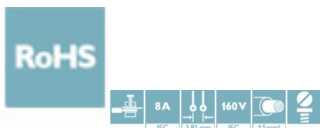

Key Commercial Data

Packing unit	1 pc
Minimum order quantity	100 pc
GTIN	 4 046356 850506
GTIN	4046356850506
Weight per Piece (excluding packing)	3.400 g
Custom tariff number	85366990
Country of origin	China

Technical data

Dimensions

Length [l]	16.1 mm
Width [w]	21.82 mm
Height [h]	11.1 mm
Pitch	3.81 mm
Dimension a	7.62 mm

General

Range of articles	BCP-F
Number of positions	3

Printed-circuit board connector - BCP-381F- 3 BK - 5452531

Technical data

General

Connection method	Screw connection with tension sleeve
Insulating material group	I
Rated surge voltage (III/3)	2.5 kV
Rated surge voltage (III/2)	2.5 kV
Rated surge voltage (II/2)	2.5 kV
Rated voltage (III/3)	160 V
Rated voltage (III/2)	160 V
Rated voltage (II/2)	320 V
Connection in acc. with standard	EN-VDE
Nominal current I_N	8 A
Nominal cross section	1.5 mm ²
Maximum load current	8 A (with 1.5 mm ² conductor cross section)
Insulating material	PA
Flammability rating according to UL 94	V0
Internal cylindrical gage	A1
Stripping length	7 mm
Screw thread	M2
Tightening torque, min	0.22 Nm
Tightening torque max	0.25 Nm

Connection data

Conductor cross section solid min.	0.2 mm ²
Conductor cross section solid max.	1.5 mm ²
Conductor cross section flexible min.	0.2 mm ²
Conductor cross section flexible max.	1.5 mm ²
Conductor cross section flexible, with ferrule without plastic sleeve min.	0.25 mm ²
Conductor cross section flexible, with ferrule without plastic sleeve max.	1.5 mm ²
Conductor cross section flexible, with ferrule with plastic sleeve min.	0.25 mm ²
Conductor cross section flexible, with ferrule with plastic sleeve max.	0.5 mm ²
Conductor cross section AWG min.	24
Conductor cross section AWG max.	16
2 conductors with same cross section, solid min.	0.2 mm ²
2 conductors with same cross section, solid max.	0.5 mm ²
2 conductors with same cross section, stranded min.	0.25 mm ²
2 conductors with same cross section, stranded max.	0.75 mm ²
Two conductors with the same cross section stranded, with ferrule and without plastic sleeve, minimum	0.25 mm ²

Printed-circuit board connector - BCP-381F- 3 BK - 5452531

Technical data

Connection data

Two conductors with the same cross section stranded, with ferrule and without plastic sleeve, maximum	0.34 mm ²
Two conductors with the same cross section, flexible, with TWIN ferrules, with plastic sleeve, minimum	0.5 mm ²
Two conductors with the same cross section, flexible, with TWIN ferrules, with plastic sleeve, maximum	0.5 mm ²

Standards and Regulations

Connection in acc. with standard	EN-VDE
	CUL
Flammability rating according to UL 94	V0

Environmental Product Compliance

REACH SVHC	Lead 7439-92-1
China RoHS	Environmentally Friendly Use Period = 50 years
	For details about hazardous substances go to tab "Downloads", Category "Manufacturer's declaration"

Drawings

Diagram

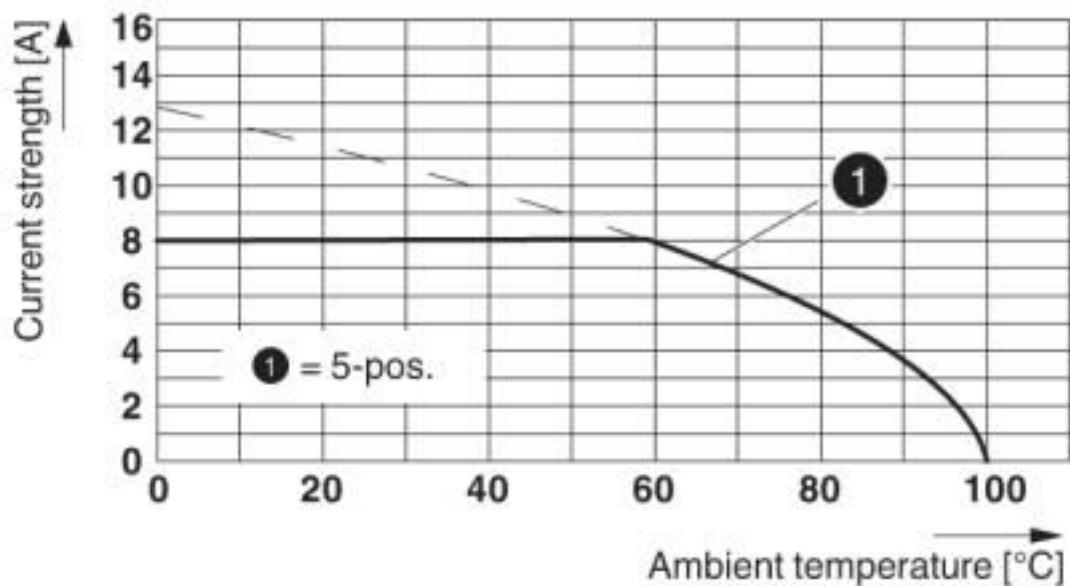

Printed-circuit board connector - BCP-381F- 3 BK - 5452531

Dimensional drawing

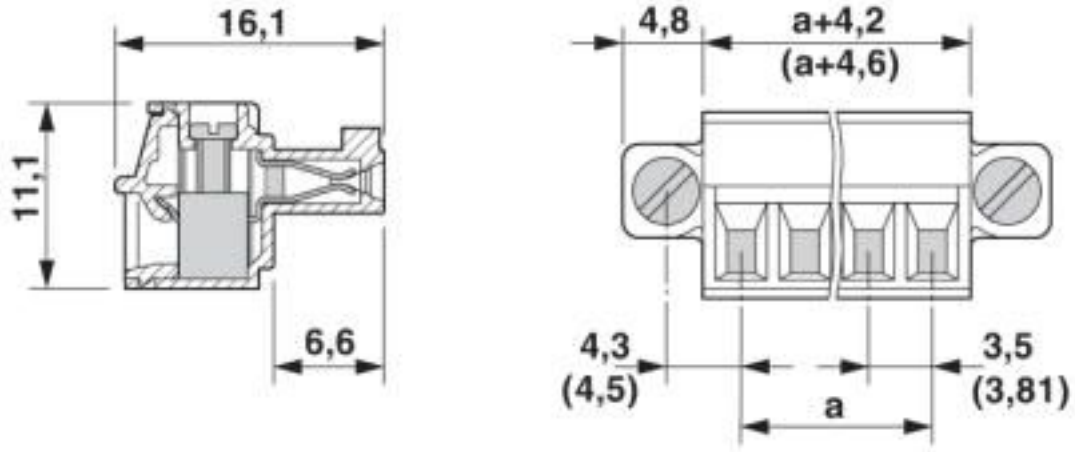

Classifications

eCl@ss

eCl@ss 10.0.1	27440309
eCl@ss 4.0	27260700
eCl@ss 4.1	27260700
eCl@ss 5.0	27260700
eCl@ss 5.1	27260700
eCl@ss 6.0	27260700
eCl@ss 7.0	27440309
eCl@ss 8.0	27440309
eCl@ss 9.0	27440309

ETIM

ETIM 3.0	EC001121
ETIM 4.0	EC002637
ETIM 5.0	EC002638
ETIM 6.0	EC002638
ETIM 7.0	EC002638

UNSPSC

UNSPSC 6.01	30211801
UNSPSC 7.0901	39121432
UNSPSC 11	39121432
UNSPSC 12.01	39121409
UNSPSC 13.2	39121409

Printed-circuit board connector - BCP-381F- 3 BK - 5452531

Classifications

UNSPSC

UNSPSC 18.0	39121409
UNSPSC 19.0	39121409
UNSPSC 20.0	39121409
UNSPSC 21.0	39121409

Approvals

Approvals

Approvals

IECEE CB Scheme / VDE Gutachten mit Fertigungsüberwachung / cULus Recognized / EAC

Ex Approvals

Approval details

IECEE CB Scheme		http://www.iecee.org/	DE1-58974
-----------------	---	---	-----------

VDE Gutachten mit Fertigungsüberwachung		http://www2.vde.com/de/Institut/Online-Service/VDE-gepruefteProdukte/Seiten/Online-Suche.aspx	40040694
Nominal voltage UN	160 V		
Nominal current IN	8 A		
mm ² /AWG/kcmil	0.2-1.5		

cULus Recognized		http://database.ul.com/cgi-bin/XYV/template/LISEXT/1FRAME/index.htm	E60425-20071007
	B	D	
Nominal voltage UN	250 V	300 V	
Nominal current IN	8 A	8 A	
mm ² /AWG/kcmil	30-14	30-14	

Printed-circuit board connector - BCP-381F- 3 BK - 5452531

Approvals

EAC



B.01687

Accessories

Accessories

Labeled terminal marker

Marker card - SK 3,5/2,8:FORTL.ZAHLEN - 0804073



Marker card, Card, white, labeled, horizontal: consecutive numbers 1 ... 10, 11 ... 20, etc. up to 91 ... 99, mounting type: adhesive, for terminal block width: 3.5 mm, lettering field size: 3.5 x 2.8 mm

Screwdriver tools

Screwdriver - SZS 0,4X2,5 VDE - 1205037



Screwdriver, slot-headed, VDE insulated, size: 0.4 x 2.5 x 80 mm, 2-component grip, with non-slip grip

X-ON Electronics

Largest Supplier of Electrical and Electronic Components

Click to view similar products for [Pluggable Terminal Blocks](#) category:

Click to view products by [Phoenix Contact](#) manufacturer:

Other Similar products are found below :

[57.404.7553](#) [57.504.0053.7](#) [57.510.0053](#) [57.910.6153](#) [01.112.1453](#) [CTB932VE/6](#) [MC 1.5/ 6-ST-3.5 GY AU](#) [ET02015000J0G](#) [734-104](#) [734-302](#) [734-304](#) [8-141-P](#) [FKCT 2.5/ 3-ST KMGY](#) [860505](#) [860508](#) [860516](#) [860810](#) [861908](#) [GBPACX-12](#) [93.731.4953.0](#) [PV05-5,08-K](#) [PVP02-5,00](#) [PVP04-3,50](#) [PVS02-5,00](#) [1-1986160-3](#) [H-10](#) [ELFH09150](#) [ELFH16150](#) [ELFP03110](#) [ELFT06250](#) [ELFT07250](#) [ELVF09400](#) [ELVP03100](#) [ELXH03100](#) [ELXH071G0E](#) [ELXP041G0](#) [ELXT046G0](#) [1700101](#) [1700410](#) [1700425](#) [1703176](#) [1705229](#) [1710175](#) [1714537](#) [1717806](#) [1719600](#) [1729386](#) [1734692](#) [1734795](#) [1736036](#)