

# HEAVYCON EVO

## Market requirements

- Cost-efficiency
- Logistic-efficiency
- Easy to install
- Ecologically aspects



# HEAVYCON EVO

## Product introduction

The evolution in heavy-duty connectors



# HEAVYCON EVO

## Product introduction



M20, M25, M32 and M40

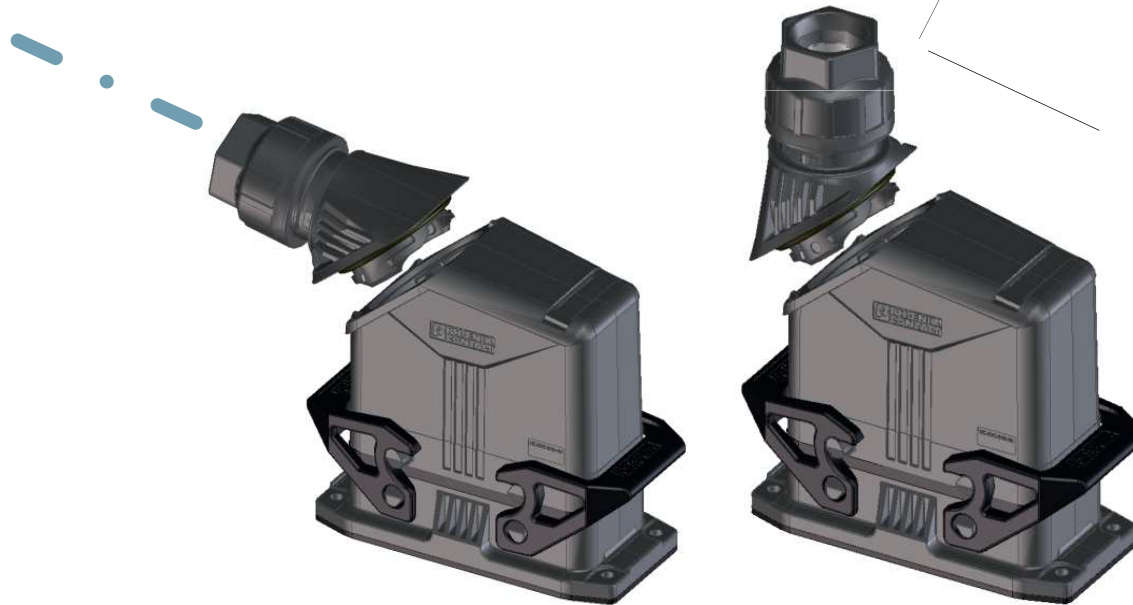

IP65 /  
NEMA 4X

HC EVO-Lock:  
Cable gland with  
bayonett lock

# HEAVYCON EVO

## Product introduction

### Metal inlays ensure premating PE contact

DIN EN 61 984  
DIN EN 60 664-1  
UL 1977



Two metal inlays are used in the housings to fix the contact inserts and coding screws.

Meanwhile they serve as an electric bridge between PE-contact of the male and female inserts, so as to ensure the conformity to norms.

# HEAVYCON EVO

## Product introduction

### Asymmetric top entry

- Good ergonomics
- Smart cable leading

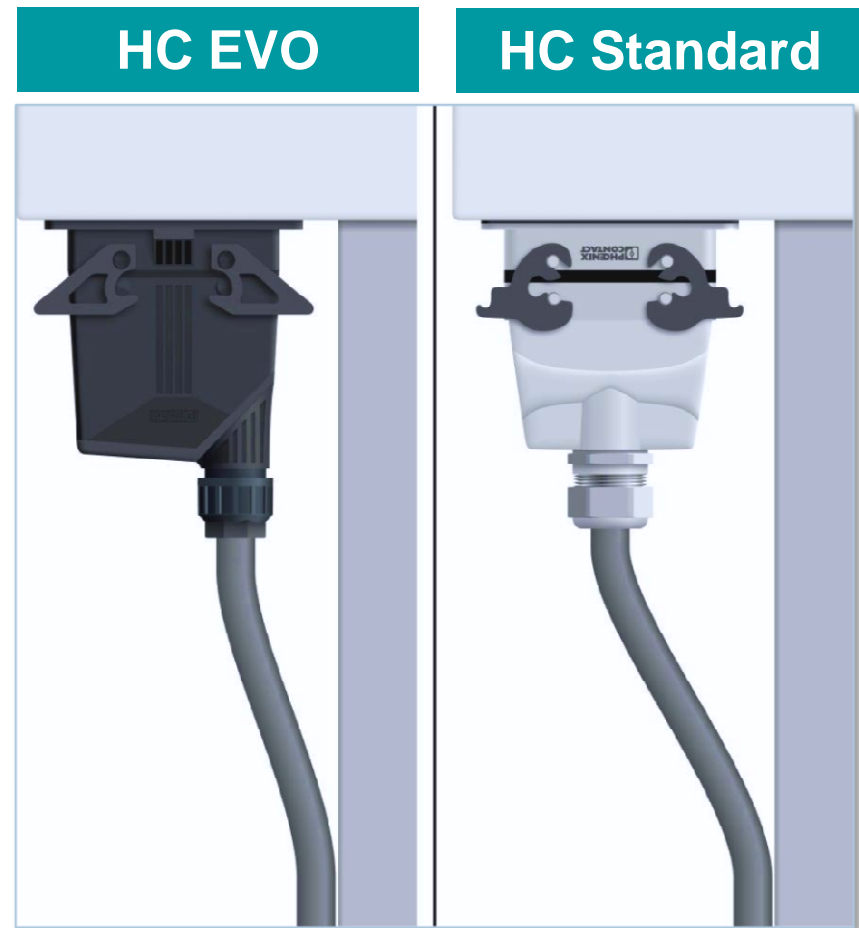

# HEAVYCON EVO

Product introduction

Mounting by hand



Dismounting with tool



# HEAVYCON EVO

## Product introduction

Easy installation due to HC EVO-Lock

HC EVO



HC Standard



# HEAVYCON EVO

## Product introduction

### Advantages of plastic material

- Cost-saving of 25%
- 50% reduction in weight
- 80% energy saving in production (plastic vs. aluminium)
- Excellent mechanical properties, high resistance against environmental influences. (IK08)
- Suitable for protection class II
- Halogen free and guaranteed UL94 V0 (flammability retardance class)





# HEAVYCON EVO

## Product introduction



### Sustainable use of resources

PP KEA : 118,8 MJ/Kg

Alu KEA : 193,3 MJ/Kg

Tabelle 2: Produktionsenergie als kumulierter Energieaufwand (KEA) im Vergleich zu Beschaffungs- und Entsorgungskosten von Kunststoffen und anderen Materialien

Material	KEA MJ/kg	Beschaffungskosten		Heizwert MJ/kg
		€/t	€/MWh KEA	
Naphtha (Rohbenzin)	55	332	21,7	43,5
LDPE Folie	91,8	800	31,4	46
HDPE Folie	99,8	800	28,9	46
PP Spritzguss	118,8	850	25,7	44
PVC Folie	66,3	820	44,6	20
PS (high impact)	91,8	860	33,7	46
PET Flasche	101,4	1060	37,6	46
PET Folie	109,2	1020	33,6	46
Stahl	35,8	247	24,8	0
Aluminium	193,3	1450	27,0	0
Weißglas	12,7	140	39,6	0
Wellpappe, Karton	19,8	160	29,1	15
Papier (grafische etc.)	44,8	500	40,2	17
Holzspäne f. Pressplatten	17,0	55	11,6	16
Stammholz, frisch	14,0	150	38,6	10
Stammholz, getrocknet	19,0	220	41,7	15

Ecological backback factors:  
5 for plastics / 75 for aluminium

# HEAVYCON EVO

## Product introduction

### Complete programm

- The HC-EVO hoods made of plastic are available in size of **B6, B10, B16 and B24** with single or double locking latches.
- The corresponding housings are bulkhead housings, panel mount housings and coupling housing **with or without protection cover**.
- All cable glands of standard sizes from **M20 to M40** are covered with the HEAVYCON EVO-Lock-connection.



# HEAVYCON EVO

## Product introduction

**Fully compatible**

**Fits to all standard and HC modular inserts**



**Fully compatible to the aluminium housings of all competitors**

# HEAVYCON EVO

## Product introduction

### Advantages of the surface mount housing

- The covers are removeable to both sides
- The locking latches are changeable
- Variants are 50% reduced through optional single & double cable entry (lid can be broken out)



# HEAVYCON EVO – safety and stability



**Robust**



**Protection type IP65**



**Pull test**



**Compatible**



**Vibration test**



**-40°C to +125°C approved**

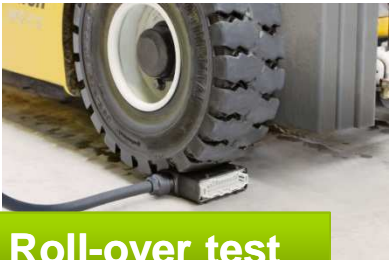

**Roll-over test**



**Impact test IK08**

**Robust and compatible as metal housings!**

# HEAVYCON EVO

Safety and stability

Long term rugged locking latches

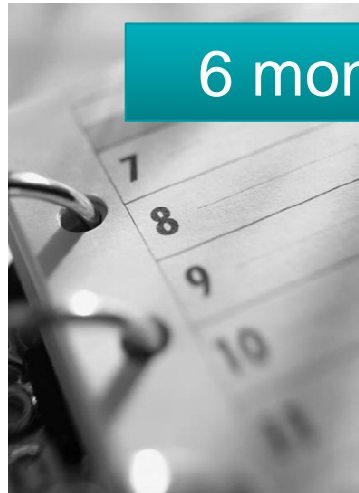

6 months

stress

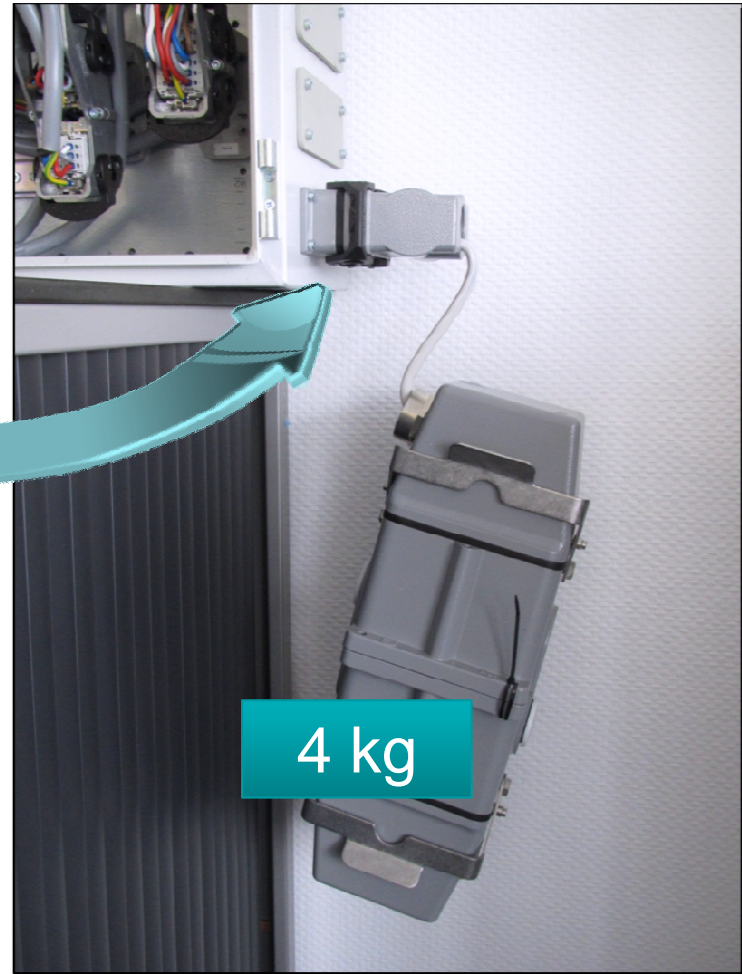

4 kg

# The evolution in heavy duty connectors

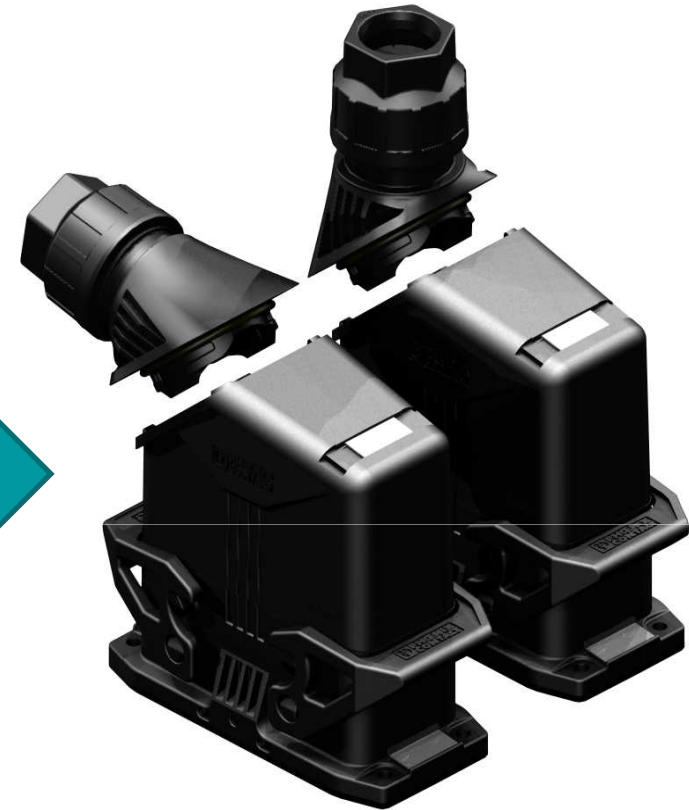
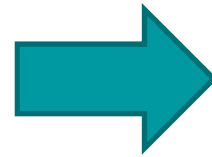

**70% Reduction of Variants  
means greater stock availability**

# HEAVYCON EVO

## Typ-ident

### EVO-housings

1	2	3	4	5	5	6	7	8	9	10	11	12	14	
HC	- EVO	- B06	- H	L	FS	C	- 1	G	M25	- PL	BK	26		
HC	- EVO	- B10	- B	L	WS	C	- 2	S	S	M32	- PLR	BK	21	
HC	- EVO	- B16	- S	L	FD	C	- 2	S	S	PG13	- PLR	BK	29	
HC	- EVO	- B16	- S	L	FD	C	- 2	S	S	PG13	- PLR	BK	30	
HC	- EVO	- B24	- C	H	WD	C	- 1	T	T	M40	- PLV	BK	28	

#### HEAVYCON

#### SERIES:

EVO = EVOLUTION

#### HOUSING TYPE & SIZE:

#### HOUSING TYPE

H = HOOD  
 B = PANEL BASE / BULKHEAD HOUSING  
 S = SURFACE MOUNT HOUSING  
 C = COUPLER HOOD

#### CONSTRUCTION HEIGHT

H = HIGH CONSTRUCTION  
 L = LOW CONSTRUCTION

#### CONNECTOR FIXING:

WS = WITH SINGLE LEVER  
 WD = WITH DOUBLE LEVER  
 FS = FOR SINGLE LEVER  
 FD = FOR DOUBLE LEVER

#### DUST COVER:

C = PLASTIC  
 CM = METAL

#### NUMBER OF GLAND ENTRIES:

#### LOCATION OF GLAND ENTRY

T = TOP  
 S = SIDE

#### TYPE OF ENTRY

G = WITH CABLE GLAND

#### THREAD TYPE AND SIZE

#### MATERIAL TYPE AND FINISH

PLR = PLASTIC with NBR RUBBER SEALING PROFILE  
 PLV = PLASTIC with VITON SEALING PROFILE

#### HOUSING COLOUR:

BK = BLACK



# HEAVYCON EVO

## Key features

### Reduction of total cost of ownership









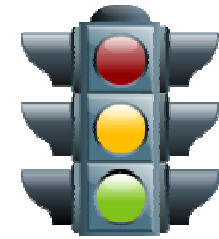



















- Less design-in costs
- Less master data in the system
- Less equipment costs in the production
- Less stock-keeping / logistics worldwide till to end customers. (15 -20 % of logistic costs is reduced by the rotatable uniform connection EVO-Lock)
- Less re-ordering positions
- Larger ordering quantity of the same type
- Less inventory holding and capital lock-up for PxC, for subsidiaries , for distributors and for end customers.
- Better availability worldwide

# HEAVYCON EVO

## Comparison with competitor products



			
<b>Material</b>	Plastic 	Plastic 	Plastic 
<b>Connection to cable glands</b>	Metric thread 	Metric thread 	HC EVO-Lock 
<b>Product range</b>	Only Double Locks 	Just one housing height 	Full program 
<b>Range of cable glands</b>	M32, M40 	M25-M40 	M20-M40 
<b>Compatibility to the Standard housings</b>	No 	Conditionally compatible 	Fully compatible 
<b>Compatibility to the Inserts</b>	Only compatible to modular inserts 	Fully compatible 	Fully compatible 
<b>Premating PE contact</b>	Optional 	No 	Yes 
<b>Mechanical features (IK 08 / 5 Joule)</b>	Acceptable 	Deficient 	Excellent 

# HEAVYCON EVO

## Field of applications



# HEAVYCON EVO

## Field of applications

Recommended applications for metal housings



Extreme cold and dry



Extreme hot and humid



Drives and **EMC**

# HEAVYCON EVO

## Accessories

### HC EVO conduit adapter

- Seperate EVO-lock version
- Protection degree IP66/68
- Particular sizes for conduit outer diameters:
  - 21,2 mm (M20) 3241220
  - 28,5 mm (M25) 3241221
  - 34,5 mm (M32) 3241222
  - 42,5 mm (M40) 3241223

For conduits please have a look  
in the new M&I catalogue

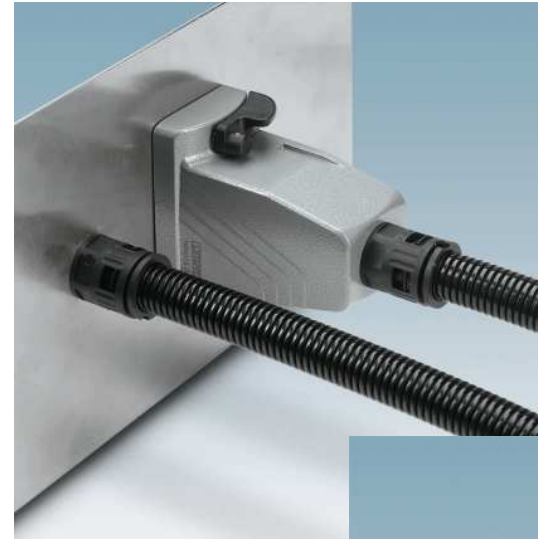

# HEAVYCON EVO

## Accessories

### Marking material US-EMP (20x9)

- With THERMOMARK CARD or THERMOMARK CARD PLUS
- 8 sec. per card
- Thermotransfer technology
- Immediate printing
- Printing with 300Dpi
- Immediately wipe and scratch resistant
- printing is very resistant against external influences



### Printing with THERMOMARK CARD (PLUS)

# HEAVYCON EVO

Final features in comparison with alu-housings



lower price

due to plastic housing

reduced stock

due to EVO-Lock cable gland

# HEAVYCON

## PT contact inserts

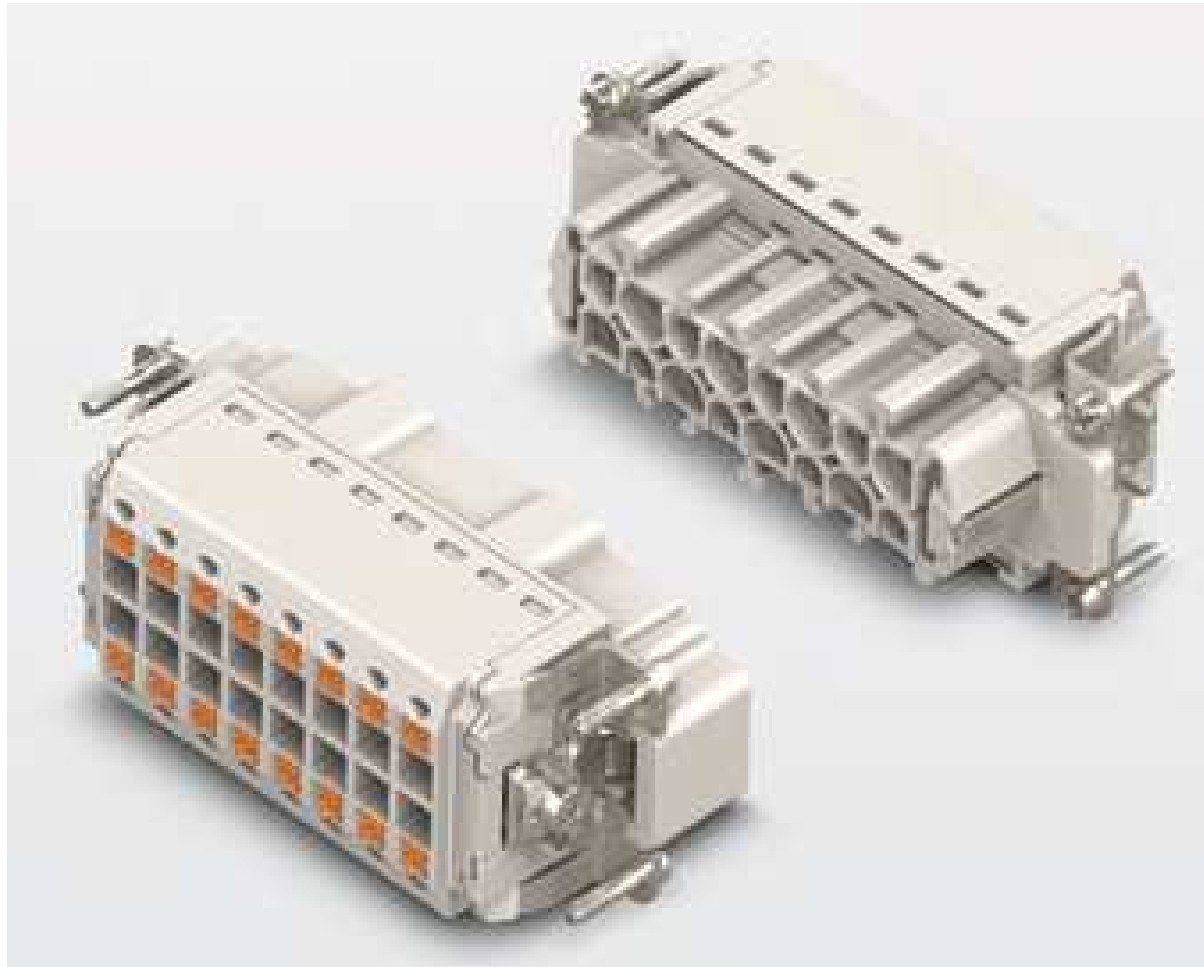



# HEAVYCON contact inserts with push-in-connection



## Installation guide

# Strategy – PLUSCON heavy



## X-ON Electronics

Largest Supplier of Electrical and Electronic Components

*Click to view similar products for [Phoenix Contact](#) manufacturer:*

Other Similar products are found below :

[1212619](#) [3240366](#) [1893300](#) [1582235](#) [1773093](#) [2814045](#) [2989433](#) [2963886](#) [2966537](#) [FFKDS/V-2.54](#) [2313944](#) [2834546](#) [DFK-PC 5/ 2-ST-7,62](#) [2834520](#) [2834407](#) [1687312](#) [3056145](#) [0902221](#) [1775619](#) [1674998](#) [2858894](#) [443023](#) [2905235](#) [2833547](#) [3240098](#) [0825544:3](#) [2905234](#) [0201391](#) [0201414](#) [CRIMPFOX 16 S](#) [CRIMPSET 25](#) [7001438](#) [MC 1,5/ 9-ST-3,5](#) [1840434](#) [ETD-BL-1T-F-300S](#) [MCR-1CLP-I-I-00](#) [MCR-4CLP-I-I-00](#) [MCR-DAC 8-I- 4-BUS](#) [MCR-SWS-I](#) [MCV 1,5/ 3-G-3,81](#) [1803439](#) [FL EPA WMS](#) [FLK 50/EZ-DR/ 400/KONFEK/S](#) [FLS PB M12 DO 8 M12-2A](#) [PPS CD BLADE](#) [PR1-RSC3-LV-120AC/21](#) [PSI-MOS-DNET CAN/FO 660/BM](#) [PSM-ME-RS232/RS232-P](#) [PSM PTK-4](#) [PSM-SET-FSMA/4-KT](#) [PT 2X2- 5DC-ST](#) [1201280](#)