

Printed-circuit board connector - MC 1,5/10-STF-3,81 - 1827787

Please be informed that the data shown in this PDF Document is generated from our Online Catalog. Please find the complete data in the user's documentation. Our General Terms of Use for Downloads are valid (<http://phoenixcontact.com/download>)

PCB connector, nominal current: 8 A, number of positions: 10, pitch: 3.81 mm, connection method: Screw connection with tension sleeve, color: green, contact surface: Tin



The figure shows a 10-position version of the product

Your advantages

- Well-known connection principle allows worldwide use
- Low temperature rise, thanks to maximum contact force
- Allows connection of two conductors
- Screwable flange for superior mechanical stability



Key Commercial Data

Packing unit	50 pc
Minimum order quantity	50 pc
GTIN	
GTIN	4017918050245
Weight per Piece (excluding packing)	7.865 g
Custom tariff number	85366990
Country of origin	Germany
Sales Key	AAAEAA

Technical data

Dimensions

Length [l]	16.1 mm
Width [w]	48.49 mm
Height [h]	11.1 mm
Pitch	3.81 mm
Dimension a	34.29 mm

General

Printed-circuit board connector - MC 1,5/10-STF-3,81 - 1827787

Technical data

General

Range of articles	MC 1,5/...STF
Number of positions	10
Connection method	Screw connection with tension sleeve
Insulating material group	I
Rated surge voltage (III/3)	2.5 kV
Rated surge voltage (III/2)	2.5 kV
Rated surge voltage (II/2)	2.5 kV
Rated voltage (III/3)	160 V
Rated voltage (III/2)	160 V
Rated voltage (II/2)	320 V
Connection in acc. with standard	EN-VDE
Nominal current I_N	8 A
Nominal cross section	1.5 mm ²
Maximum load current	8 A (with 1.5 mm ² conductor cross section)
Insulating material	PA
Flammability rating according to UL 94	V0
Internal cylindrical gage	A1
Stripping length	7 mm
Screw thread	M2
Tightening torque, min	0.22 Nm
Tightening torque max	0.25 Nm

Connection data

Conductor cross section solid min.	0.14 mm ²
Conductor cross section solid max.	1.5 mm ²
Conductor cross section flexible min.	0.14 mm ²
Conductor cross section flexible max.	1.5 mm ²
Conductor cross section flexible, with ferrule without plastic sleeve min.	0.25 mm ²
Conductor cross section flexible, with ferrule without plastic sleeve max.	1.5 mm ²
Conductor cross section flexible, with ferrule with plastic sleeve min.	0.25 mm ²
Conductor cross section flexible, with ferrule with plastic sleeve max.	0.5 mm ²
Conductor cross section AWG min.	28
Conductor cross section AWG max.	16
2 conductors with same cross section, solid min.	0.08 mm ²
2 conductors with same cross section, solid max.	0.5 mm ²
2 conductors with same cross section, stranded min.	0.08 mm ²
2 conductors with same cross section, stranded max.	0.75 mm ²
2 conductors with same cross section, stranded, ferrules without plastic sleeve, min.	0.25 mm ²
2 conductors with same cross section, stranded, ferrules without plastic sleeve, max.	0.34 mm ²

Printed-circuit board connector - MC 1,5/10-STF-3,81 - 1827787

Technical data

Connection data

2 conductors with same cross section, stranded, TWIN ferrules with plastic sleeve, min.	0.5 mm ²
2 conductors with same cross section, stranded, TWIN ferrules with plastic sleeve, max.	0.5 mm ²
Minimum AWG according to UL/CUL	30
Maximum AWG according to UL/CUL	14

Standards and Regulations

Connection in acc. with standard	EN-VDE
	CSA
Flammability rating according to UL 94	V0

Environmental Product Compliance

	Lead 7439-92-1
China RoHS	Environmentally Friendly Use Period = 50
	For details about hazardous substances go to tab "Downloads", Category "Manufacturer's declaration"

Drawings

Diagram

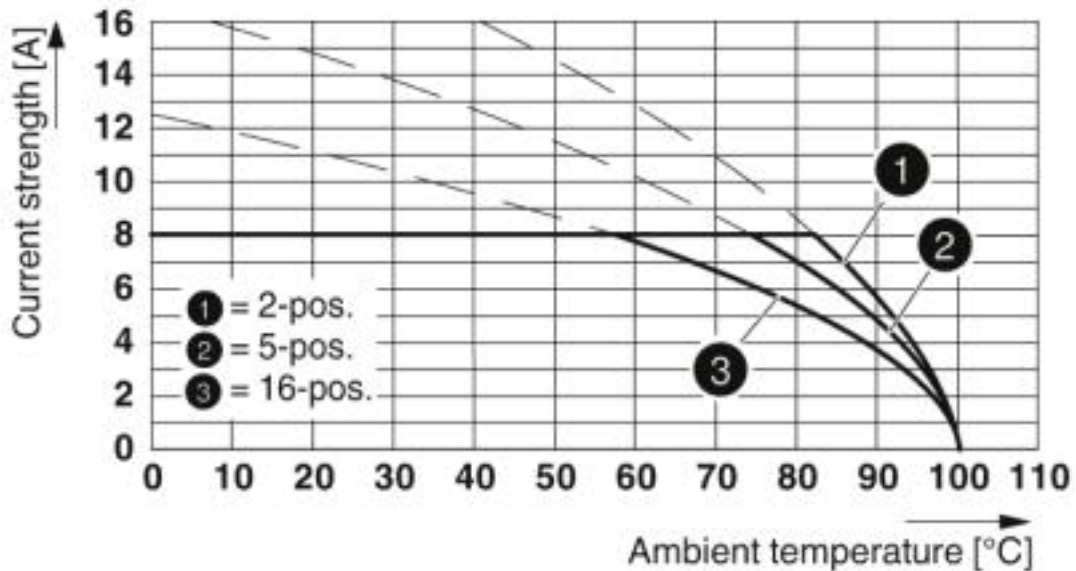

Type: MC 1,5/...-STF-3,81 with MCD 1,5/...-G1F-3,81

Printed-circuit board connector - MC 1,5/10-STF-3,81 - 1827787

Diagram

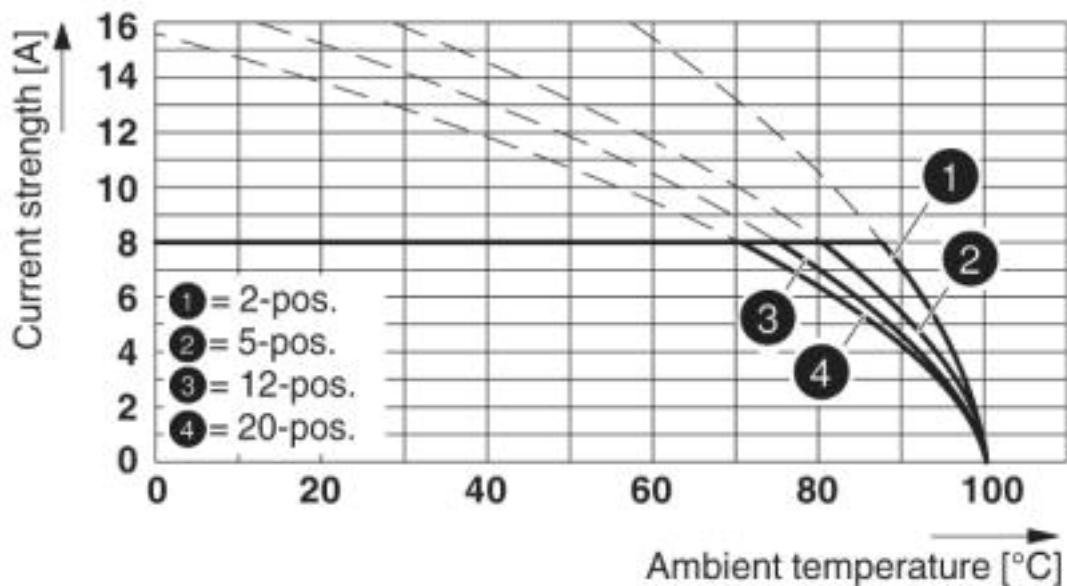

Type: MC 1,5/...-STF-3,81 with MC 1,5/...-GF-3,81

Diagram

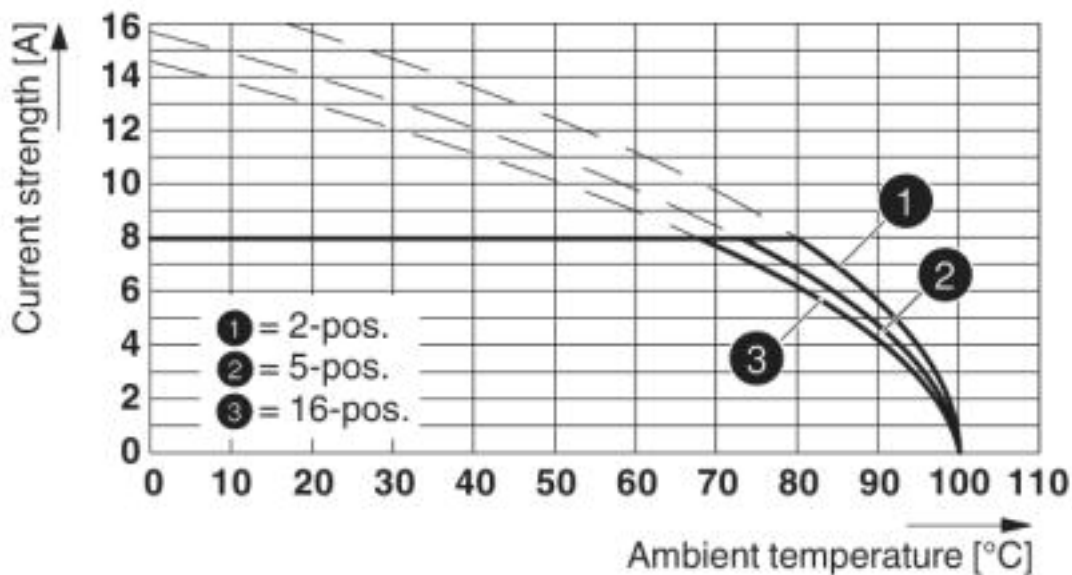

Type: MC 1,5/...-STF-3,81 with DFK-MC 1,5/...-GF-3,81 (with flat plug)

Printed-circuit board connector - MC 1,5/10-STF-3,81 - 1827787

Diagram

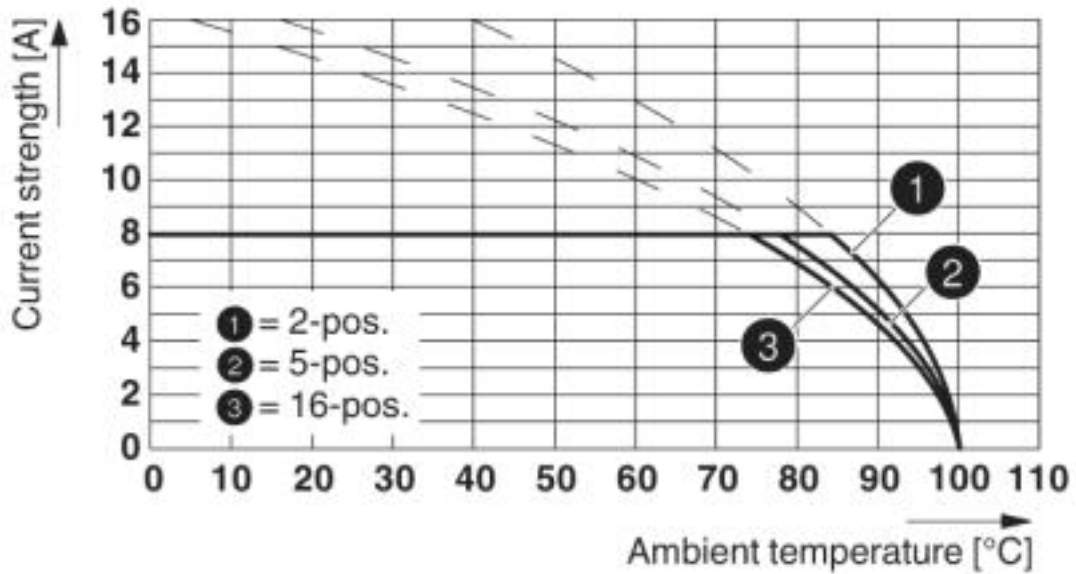

Type: MC 1,5/...-STF-3,81 with DFK-MC 1,5/...-GF-3,81 (with solder connection)

Diagram

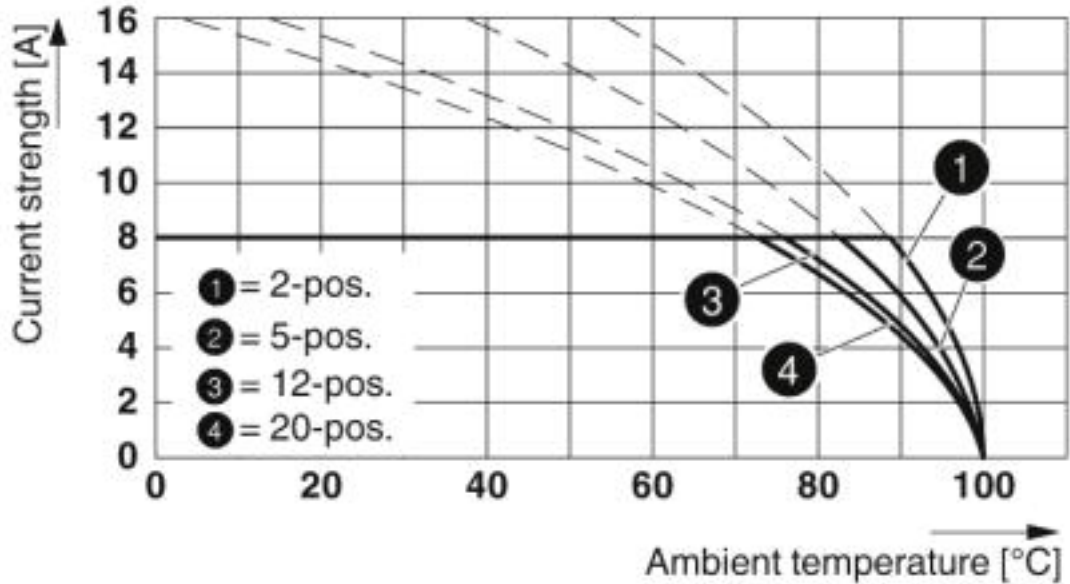

Type: MC 1,5/...-STF-3,81 with MCV 1,5/...-GF-3,81

Printed-circuit board connector - MC 1,5/10-STF-3,81 - 1827787

Diagram

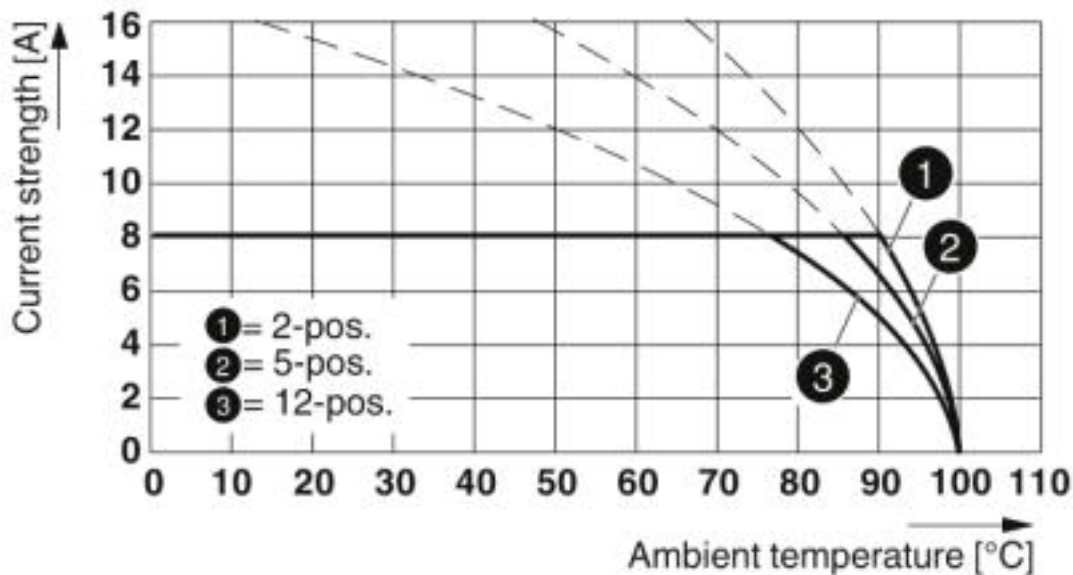

Type: MC 1,5/...-STF-3,81 with MCV 1,5/...-GF-3,81 P26 THR

Dimensional drawing

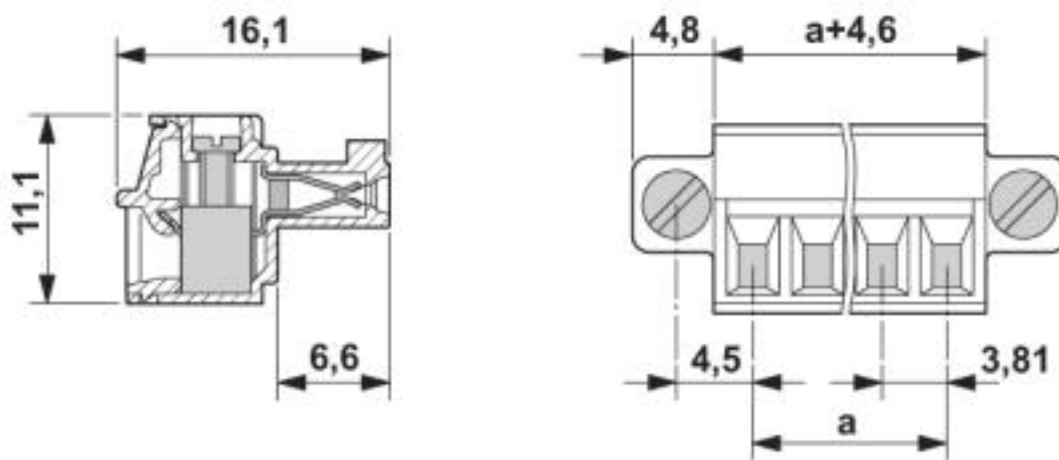

Classifications

eCl@ss

eCl@ss 4.0	27260700
eCl@ss 4.1	27260700
eCl@ss 5.0	27260700
eCl@ss 5.1	27260700
eCl@ss 6.0	27260700
eCl@ss 7.0	27440309
eCl@ss 8.0	27440309

Printed-circuit board connector - MC 1,5/10-STF-3,81 - 1827787

Classifications

eCl@ss

eCl@ss 9.0	27440309
------------	----------

ETIM

ETIM 3.0	EC001121
ETIM 4.0	EC002638
ETIM 5.0	EC002638
ETIM 6.0	EC002638
ETIM 7.0	EC002638

UNSPSC

UNSPSC 6.01	30211810
UNSPSC 7.0901	39121409
UNSPSC 11	39121409
UNSPSC 12.01	39121409
UNSPSC 13.2	39121409

Approvals

Approvals

Approvals

CSA / IECCEB CB Scheme / VDE Gutachten mit Fertigungsüberwachung / EAC / cULus Recognized

Ex Approvals

Approval details

CSA		http://www.csagroup.org/services-industries/product-listing/	13631
	B	D	
Nominal voltage UN	300 V	300 V	
Nominal current IN	8 A	8 A	
mm ² /AWG/kcmil	28-16	28-16	

IECEE CB Scheme		http://www.iecee.org/	DE1-60987-B1B2
Nominal voltage UN	160 V		

Printed-circuit board connector - MC 1,5/10-STF-3,81 - 1827787

Approvals

Nominal current IN	8 A
mm ² /AWG/kcmil	0.2-1.5

VDE Gutachten mit Fertigungsüberwachung		http://www2.vde.com/de/Institut/Online-Service/ VDE-gepruefteProdukte/Seiten/Online-Suche.aspx	40011723
Nominal voltage UN	160 V		
Nominal current IN	8 A		
mm ² /AWG/kcmil	0.2-1.5		

EAC		B.01742
-----	--	---------

cULus Recognized		http://database.ul.com/cgi-bin/XYV/template/LISEXT/1FRAME/index.htm	E60425-20110128
	B	D	
Nominal voltage UN	300 V	300 V	
Nominal current IN	8 A	8 A	
mm ² /AWG/kcmil	30-14	30-14	

Accessories

Accessories

Bridge

Insertion bridge - EBPL 2-3,81 - 1733495



Insertion bridge for plugs featuring a screw connection with a 3.81 mm pitch

Insertion bridge - EBPL 3-3,81 - 1733505



Insertion bridge for plugs featuring a screw connection with a 3.81 mm pitch

Printed-circuit board connector - MC 1,5/10-STF-3,81 - 1827787

Accessories

Insertion bridge - EBPL 4-3,81 - 1733518



Insertion bridge for plugs featuring a screw connection with a 3.81 mm pitch

Cable housing

Cable housing - KGG-MC 1,5/10 - 1834424



Cable housing, pitch: 3.81 mm, number of positions: 10, dimension a: 40.49 mm, color: green

Labeled terminal marker

Marker card - SK 3,81/2,8:FORTL.ZAHLEN - 0804109



Marker card, Card, white, labeled, Horizontal: consecutive numbers 1 ... 10, 11 ... 20, etc. up to 91 ... (99)100, mounting type: adhesive, for terminal block width: 3.81 mm, lettering field size: 3.81 x 2.8 mm

Marker pen

Marker pen - B-STIFT - 1051993



Marker pen, for manual labeling of unprinted Zack strips, smear-proof and waterproof, line thickness 0.5 mm

Screwdriver tools

Screwdriver - SZS 0,4X2,5 VDE - 1205037



Screwdriver, slot-headed, VDE insulated, size: 0.4 x 2.5 x 80 mm, 2-component grip, with non-slip grip

Printed-circuit board connector - MC 1,5/10-STF-3,81 - 1827787

Accessories

Additional products

Printed-circuit board connector - MCV 1,5/10-GF-3,81 P14 THR - 1707298

PCB headers, nominal current: 8 A, number of positions: 10, pitch: 3.81 mm, color: black, contact surface: Tin, mounting: THR soldering, User information and design recommendations for through hole reflow technology can be found under "Downloads"



Printed-circuit board connector - MCV 1,5/10-GF-3,81 P26 THR - 1707719

PCB headers, nominal current: 8 A, number of positions: 10, pitch: 3.81 mm, color: black, contact surface: Tin, mounting: THR soldering, User information and design recommendations for through hole reflow technology can be found under "Downloads"



Feed-through header - MCV 1,5/10-GF-3,81 P26 THRR72 - 1713428

PCB headers, nominal current: 8 A, number of positions: 10, pitch: 3.81 mm, color: black, contact surface: Tin, mounting: THR soldering, User information and design recommendations for through hole reflow technology can be found under "Downloads"



Printed-circuit board connector - MC 1,5/10-GF-3,81 P20 THRR72 - 1782103

PCB headers, nominal current: 8 A, number of positions: 10, pitch: 3.81 mm, color: black, contact surface: Tin, mounting: THR soldering



Feed-through header - SMC 1,5/10-GF-3,81 - 1827509

PCB headers, nominal current: 8 A, number of positions: 10, pitch: 3.81 mm, color: green, contact surface: Tin, mounting: Wave soldering



Printed-circuit board connector - MC 1,5/10-STF-3,81 - 1827787

Accessories

Printed-circuit board connector - MC 1,5/10-GF-3,81 - 1827949

PCB headers, nominal current: 8 A, number of positions: 10, pitch: 3.81 mm, color: green, contact surface: Tin, mounting: Wave soldering



Feed-through header - MCD 1,5/10-GF-3,81 - 1830185



PCB headers, nominal current: 8 A, number of positions: 10, pitch: 3.81 mm, color: green, contact surface: Tin, mounting: Wave soldering, In combination with MCV plug components, both an MCVW and an MCVR plug must be used.

Feed-through header - MCDV 1,5/10-GF-3,81 - 1830334



PCB headers, nominal current: 8 A, number of positions: 10, pitch: 3.81 mm, color: green, contact surface: Tin, mounting: Wave soldering, In combination with MCV plug components, both an MCVW and an MCVR plug must be used.

Feed-through header - MCV 1,5/10-GF-3,81 - 1830677



PCB headers, nominal current: 8 A, number of positions: 10, pitch: 3.81 mm, color: green, contact surface: Tin, mounting: Wave soldering

Feed-through header - MCDV 1,5/10-G1F-3,81 - 1842843



PCB headers, nominal current: 8 A, number of positions: 10, pitch: 3.81 mm, color: green, contact surface: Tin, mounting: Wave soldering, In combination with MCV plug components, both an MCVW and an MCVR plug must be used.

Printed-circuit board connector - MC 1,5/10-STF-3,81 - 1827787

Accessories

Printed-circuit board connector - MCD 1,5/10-G1F-3,81 - 1842995



PCB headers, nominal current: 8 A, number of positions: 10, pitch: 3.81 mm, color: green, contact surface: Tin, mounting: Wave soldering, In combination with MCV plug components, both an MCVW and an MCVR plug must be used.

Feed-through header - EMCV 1,5/10-GF-3,81 - 1879366



PCB headers, nominal current: 8 A, number of positions: 10, pitch: 3.81 mm, color: green, contact surface: Tin, mounting: Press-in technology

Feed-through header - EMC 1,5/10-GF-3,81 - 1897021



PCB headers, nominal current: 8 A, number of positions: 10, pitch: 3.81 mm, color: green, contact surface: Tin, mounting: Press-in technology

Feed-through header - MC 1,5/10-GF-3,81 THT - 1909113



PCB headers, number of positions: 10, pitch: 3.81 mm, color: black, User information and design recommendations for through hole reflow technology can be found under "Downloads"

Feed-through header - MC 1,5/10-GF-3,81 THT-R72 - 1996618



PCB headers, number of positions: 10, pitch: 3.81 mm, color: black, User information and design recommendations for through hole reflow technology can be found under "Downloads"

X-ON Electronics

Largest Supplier of Electrical and Electronic Components

Click to view similar products for [Pluggable Terminal Blocks](#) category:

Click to view products by [Phoenix Contact](#) manufacturer:

Other Similar products are found below :

[57.404.7553](#) [57.504.0053.7](#) [57.510.0053](#) [57.910.6153](#) [01.112.1453](#) [CTB932VE/6](#) [MC 1.5/ 6-ST-3.5 GY AU](#) [ET02015000J0G](#) [734-104](#) [734-302](#) [734-304](#) [8-141-P](#) [FKCT 2.5/ 3-ST KMGY](#) [860505](#) [860508](#) [860516](#) [860810](#) [861908](#) [GBPACX-12](#) [93.731.4953.0](#) [PV05-5,08-K](#) [PVP02-5,00](#) [PVP04-3,50](#) [PVS02-5,00](#) [1-1986160-3](#) [H-10](#) [1546228-5](#) [ELFH09150](#) [ELFH16150](#) [ELFP03110](#) [ELFT06250](#) [ELFT07250](#) [ELVF09400](#) [ELVP03100](#) [ELXH03100](#) [ELXH071G0E](#) [ELXP041G0](#) [ELXT046G0](#) [1700101](#) [1700410](#) [1700425](#) [1703176](#) [1705229](#) [1710175](#) [1714537](#) [1717806](#) [1719600](#) [1729386](#) [1734692](#) [1734795](#)