

Printed-circuit board connector - MSTB 2,5/10-ST - 1754601

Please be informed that the data shown in this PDF Document is generated from our Online Catalog. Please find the complete data in the user's documentation. Our General Terms of Use for Downloads are valid (<http://phoenixcontact.com/download>)

PCB connector, nominal current: 12 A, rated voltage (III/2): 320 V, number of positions: 10, pitch: 5 mm, connection method: Screw connection with tension sleeve, color: green, contact surface: Tin



Your advantages

- Well-known connection principle allows worldwide use
- Low temperature rise, thanks to maximum contact force
- Allows connection of two conductors

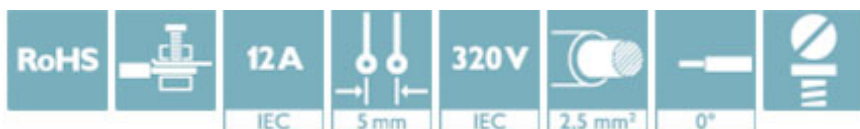

Key Commercial Data

Packing unit	50 pc
Minimum order quantity	50 pc
GTIN	 4 017918 028770
GTIN	4017918028770
Weight per Piece (excluding packing)	0.016 kg
Custom tariff number	85366990
Country of origin	Germany

Technical data

Dimensions

Length [l]	18.2 mm
Width [w]	50 mm
Height [h]	15 mm
Pitch	5 mm
Dimension a	45 mm

General

Range of articles	MSTB 2,5/..-ST
Number of positions	10
Connection method	Screw connection with tension sleeve

Printed-circuit board connector - MSTB 2,5/10-ST - 1754601

Technical data

General

Insulating material group	I
Rated surge voltage (III/3)	4 kV
Rated surge voltage (III/2)	4 kV
Rated surge voltage (II/2)	4 kV
Rated voltage (III/3)	250 V
Rated voltage (III/2)	320 V
Rated voltage (II/2)	630 V
Connection in acc. with standard	EN-VDE
Nominal current I_N	12 A
Nominal cross section	2.5 mm ²
Maximum load current	12 A (with a 2.5 mm ² conductor cross section)
Insulating material	PA
Flammability rating according to UL 94	V0
Internal cylindrical gage	A3
Stripping length	7 mm
Screw thread	M3
Tightening torque, min	0.5 Nm
Tightening torque max	0.6 Nm

Connection data

Conductor cross section solid min.	0.2 mm ²
Conductor cross section solid max.	2.5 mm ²
Conductor cross section flexible min.	0.2 mm ²
Conductor cross section flexible max.	2.5 mm ²
Conductor cross section flexible, with ferrule without plastic sleeve min.	0.25 mm ²
Conductor cross section flexible, with ferrule without plastic sleeve max.	2.5 mm ²
Conductor cross section flexible, with ferrule with plastic sleeve min.	0.25 mm ²
Conductor cross section flexible, with ferrule with plastic sleeve max.	2.5 mm ²
Conductor cross section AWG min.	24
Conductor cross section AWG max.	12
2 conductors with same cross section, solid min.	0.2 mm ²
2 conductors with same cross section, solid max.	1 mm ²
2 conductors with same cross section, stranded min.	0.2 mm ²
2 conductors with same cross section, stranded max.	1.5 mm ²
2 conductors with same cross section, stranded, ferrules without plastic sleeve, min.	0.25 mm ²
2 conductors with same cross section, stranded, ferrules without plastic sleeve, max.	1 mm ²
2 conductors with same cross section, stranded, TWIN ferrules with plastic sleeve, min.	0.5 mm ²
2 conductors with same cross section, stranded, TWIN ferrules with plastic sleeve, max.	1.5 mm ²

Printed-circuit board connector - MSTB 2,5/10-ST - 1754601

Technical data

Connection data

Minimum AWG according to UL/CUL	30
Maximum AWG according to UL/CUL	12

Standards and Regulations

Connection in acc. with standard	EN-VDE
	CSA
Flammability rating according to UL 94	V0

Environmental Product Compliance

REACH SVHC	Lead 7439-92-1
China RoHS	Environmentally Friendly Use Period = 50
	For details about hazardous substances go to tab "Downloads", Category "Manufacturer's declaration"

Drawings

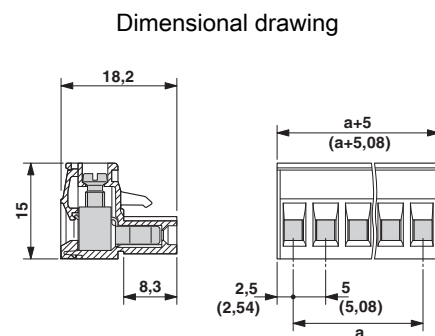
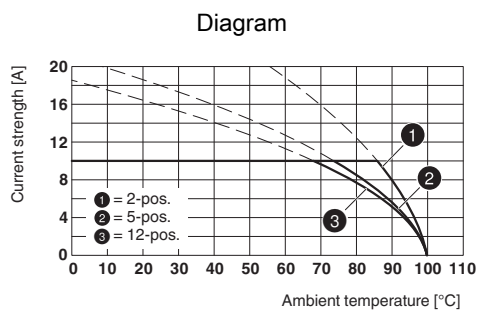

Type: MSTB 2,5/...-ST with MDSTBV 2,5/...-G

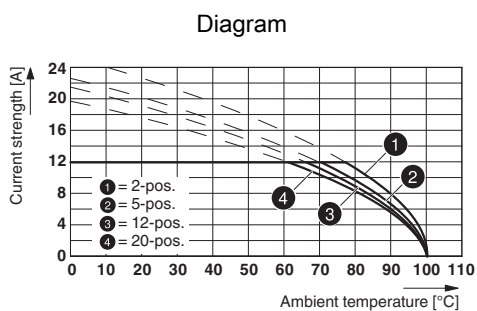

Type: MSTB 2,5/...-ST with MSTBW 2,5/...-G

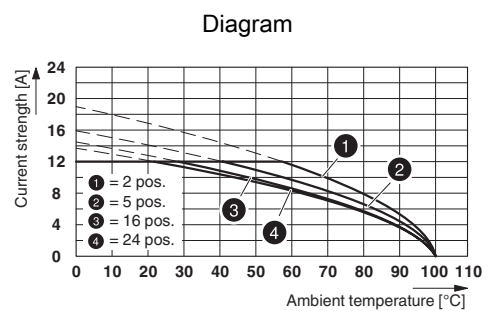

Type: MSTB 2,5/...-ST with MSTBV 2,5/...-G

Classifications

eCl@ss

eCl@ss 4.0	272607xx
eCl@ss 4.1	27260701
eCl@ss 5.0	27260701

Printed-circuit board connector - MSTB 2,5/10-ST - 1754601

Classifications

eCl@ss

eCl@ss 5.1	27260700
eCl@ss 6.0	27260700
eCl@ss 7.0	27440309
eCl@ss 8.0	27440309
eCl@ss 9.0	27440309

ETIM

ETIM 3.0	EC001121
ETIM 4.0	EC002638
ETIM 5.0	EC002638
ETIM 6.0	EC002638

UNSPSC

UNSPSC 6.01	30211810
UNSPSC 7.0901	39121409
UNSPSC 11	39121409
UNSPSC 12.01	39121409
UNSPSC 13.2	39121409

Approvals

Approvals

Approvals

CSA / IEC/CEB Scheme / VDE Gutachten mit Fertigungsüberwachung / EAC / cULus Recognized

Ex Approvals

Approval details

CSA		http://www.csagroup.org/services-industries/product-listing/	LR13631-2585950
	D	B	
Nominal voltage UN	300 V	300 V	
Nominal current IN	10 A	15 A	
mm ² /AWG/kcmil	28-12	28-12	

Printed-circuit board connector - MSTB 2,5/10-ST - 1754601

Approvals

IECEE CB Scheme		http://www.iecee.org/	DE1-58978-B1B2
Nominal voltage UN	250 V		
Nominal current IN	12 A		
mm ² /AWG/kcmil	0.2-2.5		

VDE Gutachten mit Fertigungsüberwachung		http://www2.vde.com/de/Institut/Online-Service/VDE-gepruefteProdukte/Seiten/Online-Suche.aspx	40004701
Nominal voltage UN	250 V		
Nominal current IN	12 A		
mm ² /AWG/kcmil	0.2-2.5		

EAC			B.01742
-----	--	--	---------

cULus Recognized		http://database.ul.com/cgi-bin/XYV/template/LISEXT/1FRAME/index.htm	E60425-19931011
	D	B	
Nominal voltage UN	150 V	300 V	
Nominal current IN	15 A	15 A	
mm ² /AWG/kcmil	30-12	30-12	

Accessories

Accessories

Bridge

Insertion bridge - EBP 2- 5 - 1733169

Insertion bridge, fully insulated, for connectors with 5.0 or 5.08 mm pitch, no. of positions: 2



Cable housing

Printed-circuit board connector - MSTB 2,5/10-ST - 1754601

Accessories

Cable housing - KGS-MSTB 2,5/10 - 1783740



Cable housing, pitch: 0 mm, number of positions: 10, dimension a: 50 mm, color: green

Coding element

Coding profile - CP-MSTB - 1734634



Coding profile, is inserted into the slot on the plug or inverted header, red insulating material

Labeled terminal marker

Marker card - SK 5/3,8:FORTL.ZAHLEN - 0804183



Marker card, Card, white, labeled, Horizontal: consecutive numbers 1 ... 10, 11 ... 20, etc. up to 91 ... (99)100, mounting type: adhesive, for terminal block width: 5 mm, lettering field size: 5 x 3.8 mm

Screwdriver tools

Screwdriver - SZS 0,6X3,5 - 1205053



Actuation tool, for ST terminal blocks, insulated, also suitable for use as a bladed screwdriver, size: 0.6 x 3.5 x 100 mm, 2-component grip, with non-slip grip

Additional products

Feed-through header - MSTBW 2,5/10-G - 1736030



PCB headers, nominal current: 12 A, rated voltage (III/2): 320 V, number of positions: 10, pitch: 5 mm, color: green, contact surface: Tin, mounting: Wave soldering

Printed-circuit board connector - MSTB 2,5/10-ST - 1754601

Accessories

Feed-through header - MSTBV 2,5/10-G - 1753592

PCB headers, nominal current: 12 A, rated voltage (III/2): 320 V, number of positions: 10, pitch: 5 mm, color: green, contact surface: Tin, mounting: Wave soldering



Feed-through header - MSTB 2,5/10-G - 1754591

PCB headers, nominal current: 12 A, rated voltage (III/2): 320 V, number of positions: 10, pitch: 5 mm, color: green, contact surface: Tin, mounting: Wave soldering



Printed-circuit board connector - MSTBVA 2,5/10-G - 1755503

PCB headers, nominal current: 12 A, rated voltage (III/2): 320 V, number of positions: 10, pitch: 5 mm, color: green, contact surface: Tin, mounting: Wave soldering



Printed-circuit board connector - MSTBA 2,5/10-G - 1757543

PCB headers, nominal current: 12 A, rated voltage (III/2): 320 V, number of positions: 10, pitch: 5 mm, color: green, contact surface: Tin, mounting: Wave soldering



Feed-through header - MDSTB 2,5/10-G1 - 1762774

PCB headers, nominal current: 10 A, rated voltage (III/2): 320 V, number of positions: 10, pitch: 5 mm, color: green, contact surface: Tin, mounting: Wave soldering, In combination with MVSTB or FKCV plug components, both an MVSTBW (or FKCVW) and an MVSTBR plug (or FKCVR) must be used. Combination with TMSTBP plug components is not possible!



Printed-circuit board connector - MSTB 2,5/10-ST - 1754601

Accessories

Feed-through header - MDSTBV 2,5/10-G1 - 1762923



PCB headers, nominal current: 10 A, rated voltage (III/2): 320 V, number of positions: 10, pitch: 5 mm, color: green, contact surface: Tin, mounting: Wave soldering, In combination with MVSTB or FKCV plug components, both an MVSTBW (or FKCVW) and an MVSTBR plug (or FKCVR) must be used. Combination with TMSTBP plug components is not possible!

Feed-through header - MSTB 2,5/10-G-LA - 1768260



PCB headers, nominal current: 12 A, rated voltage (III/2): 320 V, number of positions: 10, pitch: 5 mm, color: green, contact surface: Tin, mounting: Wave soldering

Printed-circuit board connector - SMSTB 2,5/10-G - 1769311



PCB headers, nominal current: 12 A, rated voltage (III/2): 320 V, number of positions: 10, pitch: 5 mm, color: green, contact surface: Tin, mounting: Wave soldering

Feed-through header - SMSTBA 2,5/10-G - 1769887



PCB headers, nominal current: 12 A, rated voltage (III/2): 320 V, number of positions: 10, pitch: 5 mm, color: green, contact surface: Tin, mounting: Wave soldering

Feed-through header - MSTBA 2,5/10-G-LA - 1770562



PCB headers, nominal current: 12 A, rated voltage (III/2): 320 V, number of positions: 10, pitch: 5 mm, color: green, contact surface: Tin, mounting: Wave soldering

Printed-circuit board connector - MSTB 2,5/10-ST - 1754601

Accessories

Feed-through header - MDSTBVA 2,5/10-G - 1845866



PCB headers, nominal current: 10 A, rated voltage (III/2): 320 V, number of positions: 10, pitch: 5 mm, color: green, contact surface: Tin, mounting: Wave soldering, The article can be aligned to create different nos. of positions! In combination with MVSTB or FKCV plug components, both an MVSTBW (or FKCVW) and an MVSTBR plug (or FKCVR) must be used. Combination with TMSTBP plug components is not possible!

Feed-through header - MDSTBV 2,5/10-G - 1846014



PCB headers, nominal current: 10 A, rated voltage (III/2): 320 V, number of positions: 10, pitch: 5 mm, color: green, contact surface: Tin, mounting: Wave soldering, Can be aligned! Mounting flange: Order No. 1836477, 1836480. In combination with MVSTB or FKCV plug components, both an MVSTBW (or FKCVW) and an MVSTBR plug (or FKCVR) must be used. Combination with TMSTBP plug components is not possible!

Feed-through header - MDSTB 2,5/10-G - 1846441



PCB headers, nominal current: 10 A, rated voltage (III/2): 320 V, number of positions: 10, pitch: 5 mm, color: green, contact surface: Tin, mounting: Wave soldering, Can be aligned! Mounting flange: Order No. 1736771, 1736768. In combination with MVSTB or FKCV plug components, both an MVSTBW (or FKCVW) and an MVSTBR plug (or FKCVR) must be used. Combination with TMSTBP plug components is not possible!

Feed-through header - MDSTBA 2,5/10-G - 1846593



PCB headers, nominal current: 10 A, rated voltage (III/2): 320 V, number of positions: 10, pitch: 5 mm, color: green, contact surface: Tin, mounting: Wave soldering, The article can be aligned to create different nos. of positions! In combination with MVSTB or FKCV plug components, both an MVSTBW (or FKCVW) and an MVSTBR plug (or FKCVR) must be used. Combination with TMSTBP plug components is not possible!

Feed-through header - MDSTBW 2,5/10-G - 1846894



PCB headers, nominal current: 10 A, rated voltage (III/2): 320 V, number of positions: 10, pitch: 5 mm, color: green, contact surface: Tin, mounting: Wave soldering, The article can be aligned to create different nos. of positions! In combination with MVSTB or FKCV plug components, both an MVSTBW (or FKCVW) and an MVSTBR plug (or FKCVR) must be used. Combination with TMSTBP plug components is not possible!

Printed-circuit board connector - MSTB 2,5/10-ST - 1754601

Accessories

Feed-through header - EMSTBA 2,5/10-G - 1899922

PCB headers, nominal current: 12 A, rated voltage (III/2): 320 V, number of positions: 10, pitch: 5 mm, color: green, contact surface: Tin, mounting: Press-in technology



Feed-through header - EMSTBVA 2,5/10-G - 1914933

PCB headers, nominal current: 12 A, rated voltage (III/2): 320 V, number of positions: 10, pitch: 5 mm, color: green, contact surface: Tin, mounting: Press-in technology



X-ON Electronics

Largest Supplier of Electrical and Electronic Components

Click to view similar products for [Pluggable Terminal Blocks](#) category:

Click to view products by [Phoenix Contact](#) manufacturer:

Other Similar products are found below :

[57.404.7553](#) [57.504.0053.7](#) [57.510.0053](#) [57.910.6153](#) [01.112.1453](#) [CTB932VE/6](#) [MC 1.5/ 6-ST-3.5 GY AU](#) [ET02015000J0G](#) [734-104](#) [734-302](#) [734-304](#) [8-141-P](#) [FKCT 2.5/ 3-ST KMGY](#) [860505](#) [860508](#) [860516](#) [860810](#) [861908](#) [GBPACX-12](#) [93.731.4953.0](#) [PV05-5,08-K](#) [PVP02-5,00](#) [PVP04-3,50](#) [PVS02-5,00](#) [1-1986160-3](#) [H-10](#) [1546228-5](#) [ELFH09150](#) [ELFH16150](#) [ELFP03110](#) [ELFT06250](#) [ELFT07250](#) [ELVF09400](#) [ELVP03100](#) [ELXH03100](#) [ELXH071G0E](#) [ELXP041G0](#) [ELXT046G0](#) [1700101](#) [1700410](#) [1700425](#) [1703176](#) [1703243](#) [1705229](#) [1710175](#) [1714537](#) [1717806](#) [1719600](#) [1728941](#) [1729386](#)