

# Interface converter - PSM-ME-RS232/TTY-P - 2744458

Please be informed that the data shown in this PDF Document is generated from our Online Catalog. Please find the complete data in the user's documentation. Our General Terms of Use for Downloads are valid (<http://phoenixcontact.com/download>)



Interface converter, for converting RS-232 (V.24) to TTY, with electrical isolation, 2 channels, rail-mountable

## Product Description

This converter converts a V.24 (RS-232) interface into a 20 mA TTY current loop interface bidirectionally. The interference immune TTY signal allows problem-free data transmission over distances of up to 1000 m using a twisted-pair and shielded 4-wire cable.

## Your advantages

- ✓ Mounting on standard EN DIN rails
- ✓ Transmission distances of up to 1000 m in active TTY mode
- ✓ High-quality 3-way isolation up to 2 kV (VCC // RS-232 // TTY)
- ✓ In the case of variable cable lengths, the TTY connection on the field side can be established conveniently using plug-in screw terminal blocks
- ✓ Integrated surge protection with transient discharge to the DIN rail
- ✓ Conversion of RS-232 TxD/RxD full duplex data signals to the TTY current loop standard
- ✓ Semi-active, active or passive TTY mode, depending on pin assignment
- ✓ 24 V DC or AC power supply suitable for the control cabinet
- ✓ Active data transmission indicated by separate data indicators for the transmit and receive channels
- ✓ RS-232 connection via 9-pos. D-SUB and standard RS-232 cable
- ✓ Transmission speed of up to 19.2 kbps
- ✓ Shipbuilding approval in accordance with DNV GL



TTY<sub>RS-232</sub>

## Key Commercial Data

Packing unit	1 pc
GTIN	 4 017918 171803
GTIN	4017918171803

## Technical data

### Note

Utilization restriction	EMC: class A product, see manufacturer's declaration in the download area
-------------------------	---

# Interface converter - PSM-ME-RS232/TTY-P - 2744458

## Technical data

### Dimensions

Caption	Slim design
Width	22.5 mm
Height	99 mm
Depth	118.6 mm

### Ambient conditions

Ambient temperature (operation)	0 °C ... 55 °C
Ambient temperature (storage/transport)	-40 °C ... 85 °C
Permissible humidity (operation)	10 % ... 95 % (non-condensing)
Altitude	≤ 5000 m (For restrictions, see the manufacturer's declaration for altitude operation)
Degree of protection	IP20
Noise immunity	EN 61000-6-2:2005

### General

Transmission channels	2 (1/1), Rx/D, Tx/D, full duplex
Bit delay	< 3 µs
Bit distortion	< 5 %
Electrical isolation	VCC // V.24 (RS-232) // TTY
Test voltage data interfaces	2 kV AC
Test voltage data interface/power supply	2 kV AC
	2 kV <sub>rms</sub> (50 Hz, 1 min.)
Electromagnetic compatibility	Conformance with EMC Directive 2014/30/EU
Noise emission	EN 61000-6-4
Net weight	179.6 g
Housing material	PA
Color	green
MTBF	1989 Years (Telcordia standard, 25°C temperature, 21% operating cycle (5 days a week, 8 hours a day))
	410 Years (Telcordia standard, 40°C temperature, 34.25% operating cycle (5 days a week, 12 hours a day))

### Power supply

Nominal supply voltage	24 V AC/DC ±20 % (via pluggable COMBICON screw terminal block)
Typical current consumption	75 mA (24 V DC)
Protective circuit	Surge protection Suppressor diode

### Interfaces

Interface 1	V.24 (RS-232) interface in acc. with ITU-T V.28, EIA/TIA-232, DIN 66259-1
Connection method	D-SUB 9 plug
Transmission length	15 m (shielded twisted pair)
Conductor cross section flexible min.	0.2 mm <sup>2</sup>
Conductor cross section flexible max.	2.5 mm <sup>2</sup>

# Interface converter - PSM-ME-RS232/TTY-P - 2744458

## Technical data

### Interfaces

Conductor cross section AWG min.	24
Conductor cross section AWG max.	13
Pin assignment	DTE/DCE switchover via switch
Protocols supported	transparent protocol
Serial transmission speed	≤ 19.2 kbps
Interface 2	TTY interface, CL2 in acc. with DIN 66348-1
Operating mode	Active, semi active, passive
Connection method	Pluggable screw connection
Transmission length	1000 m (shielded twisted pair)
Conductor cross section flexible min.	0.2 mm <sup>2</sup>
Conductor cross section flexible max.	2.5 mm <sup>2</sup>
Conductor cross section AWG min.	24
Conductor cross section AWG max.	13
Load/output load current output	≤ 500 Ω
Impedance	≤ 117 Ω (Output)
	126 Ω (Input)
Serial transmission speed	≤ 19.2 kbps
Output current	2x 20 mA ±10 % (Loop current)

### Conformance/approvals

Designation	CE
Identification	CE-compliant
Designation	EAC
Identification	EAC
Designation	UL, USA/Canada
Identification	508 Recognized
	Class I, Div. 2, Groups A, B, C, D
	Class I, Zone 2, AEx nA IIC T4
	Class I, Zone 2, Ex nA IIC T4 Gc X
Designation	Corrosive gas test
Identification	ISA-S71.04-1985 G3 Harsh Group A
Designation	Shipbuilding
Identification	DNV GL
Temperature	B
Humidity	A
Vibration	A
EMC	B
Enclosure	Required protection according to the Rules shall be provided upon installation on board

### Standards and Regulations

Electromagnetic compatibility	Conformance with EMC Directive 2014/30/EU
-------------------------------	---

## Interface converter - PSM-ME-RS232/TTY-P - 2744458

### Technical data

#### Standards and Regulations

Noise emission	EN 61000-6-4
Noise immunity	EN 61000-6-2:2005
Connection in acc. with standard	CUL
Standards/regulations	EN 61000-4-2
Contact discharge	± 6 kV (Test Level 3)
Standards/regulations	EN 61000-4-3
Frequency range	Test Level 3
Standards/regulations	EN 61000-4-4
Comments	Criterion B
Standards/regulations	EN 61000-4-5
Signal	± 2 kV (42 Ω)
Standards/regulations	EN 55011
	EN 61000-4-6

#### Environmental Product Compliance

REACH SVHC	Lead 7439-92-1
China RoHS	Environmentally Friendly Use Period = 50 years
	For details about hazardous substances go to tab "Downloads", Category "Manufacturer's declaration"

### Drawings

# Interface converter - PSM-ME-RS232/TTY-P - 2744458

Application drawing

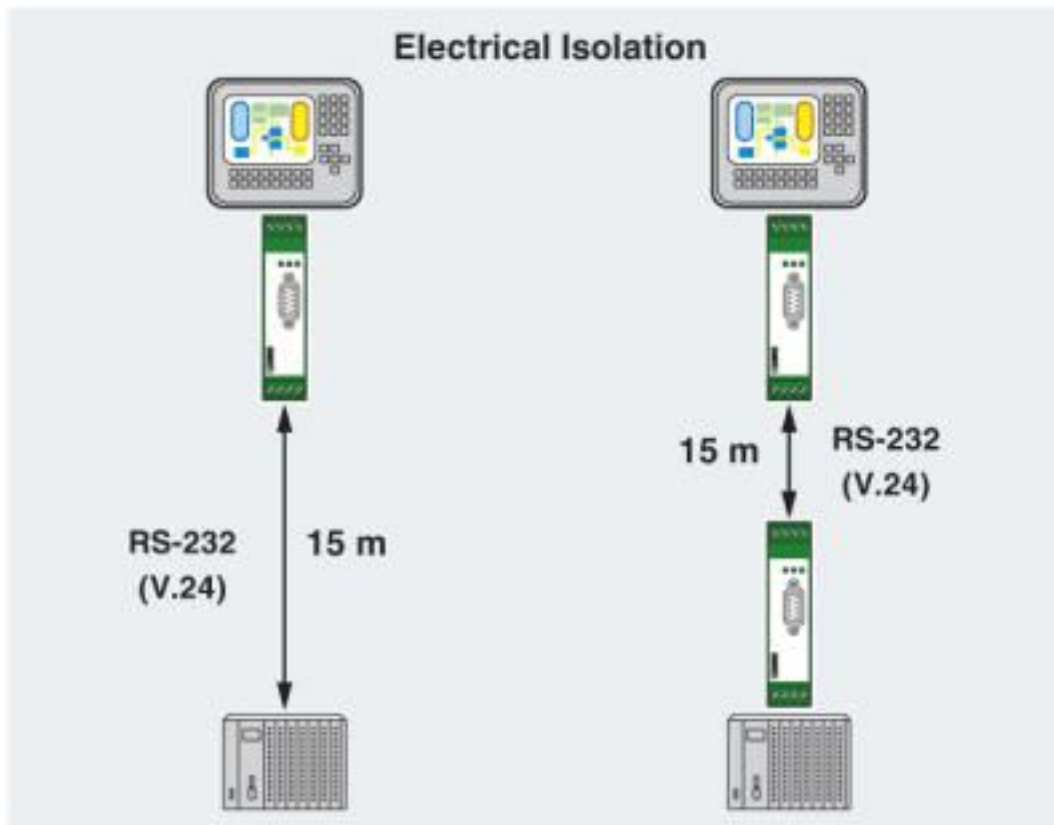

Electrical isolation

# Interface converter - PSM-ME-RS232/TTY-P - 2744458

Application drawing

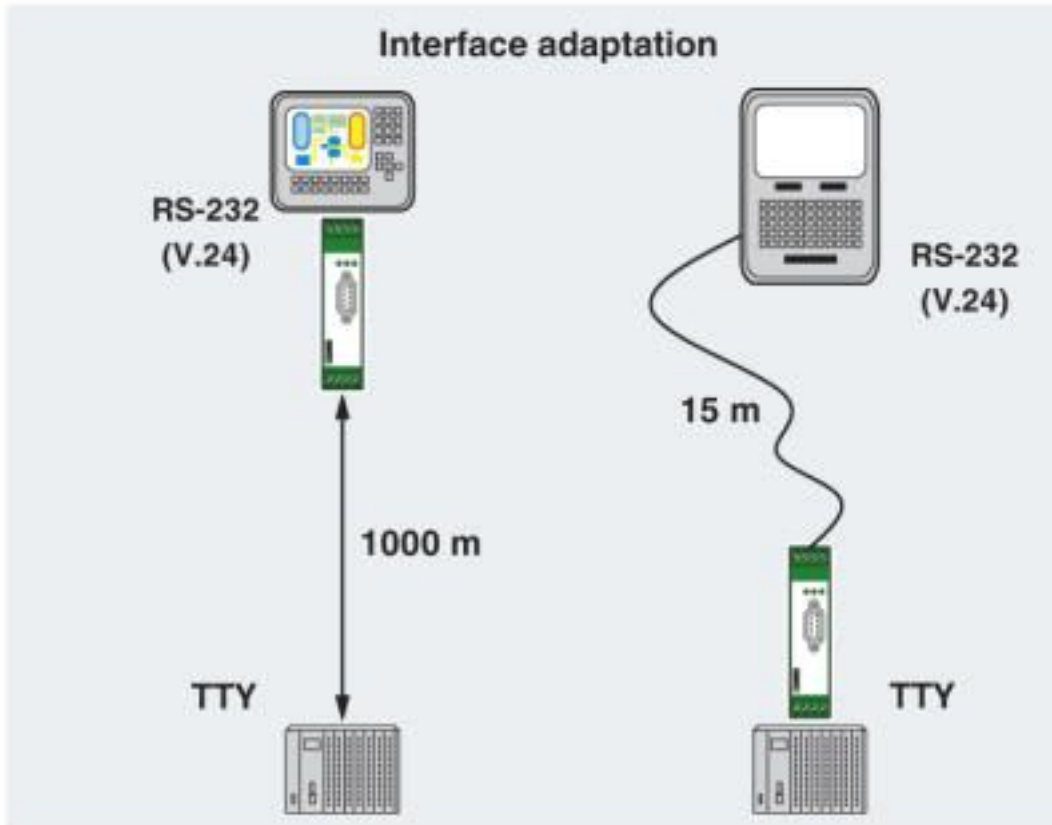

Interface adaptation

# Interface converter - PSM-ME-RS232/TTY-P - 2744458

Dimensional drawing

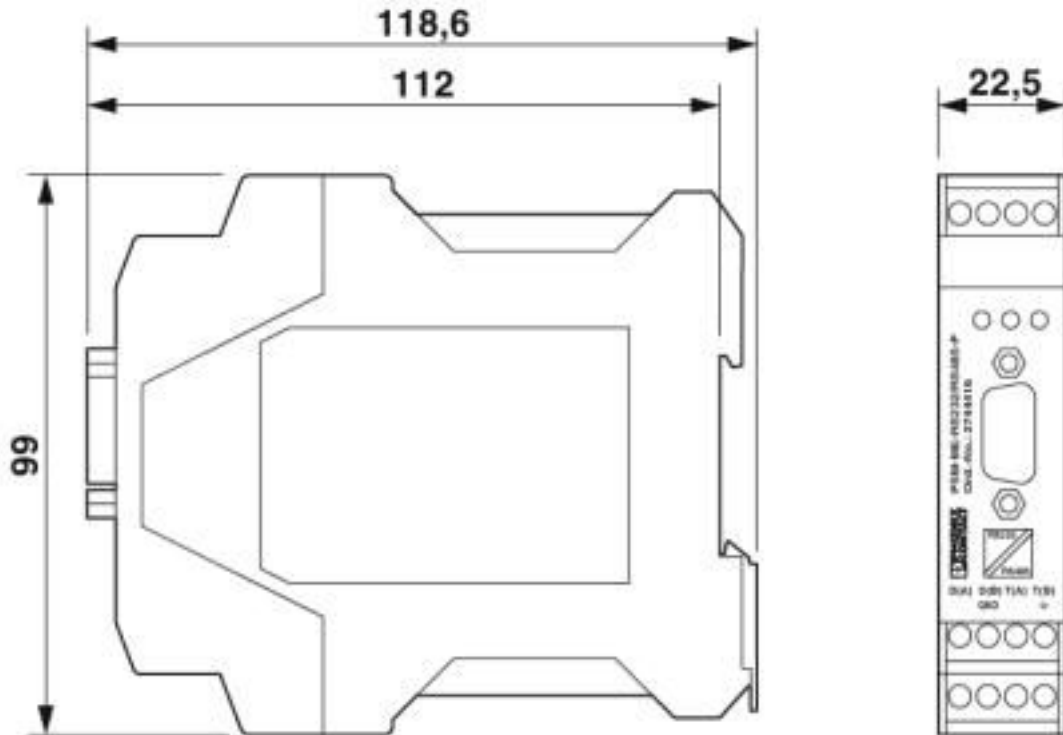

Slim design

Circuit diagram

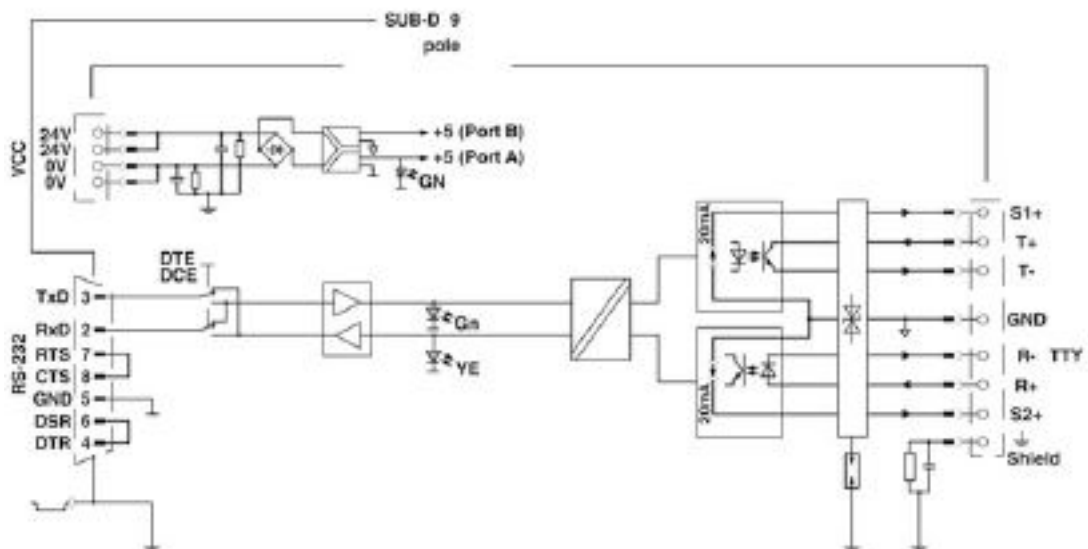

# Interface converter - PSM-ME-RS232/TTY-P - 2744458

Schematic diagram

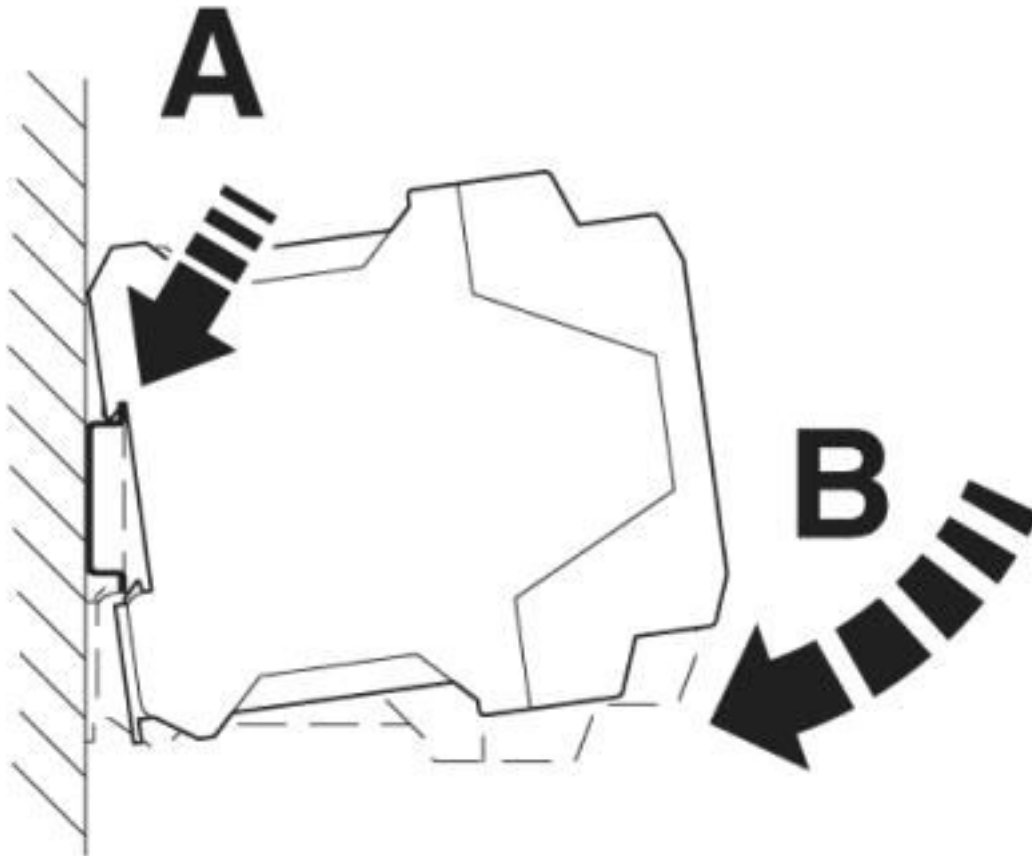

Mounting

## Classifications

eCl@ss

eCl@ss 10.0.1	19179290
eCl@ss 4.0	27250300
eCl@ss 4.1	27250300
eCl@ss 5.0	27242200
eCl@ss 5.1	27242200
eCl@ss 6.0	19179200
eCl@ss 7.0	19179290
eCl@ss 8.0	19179290
eCl@ss 9.0	19179290

ETIM

ETIM 2.0	EC000698
ETIM 3.0	EC000698
ETIM 4.0	EC000698



# Interface converter - PSM-ME-RS232/TTY-P - 2744458

## Classifications

### ETIM

ETIM 5.0	EC000310
ETIM 6.0	EC000310
ETIM 7.0	EC000310

### UNSPSC

UNSPSC 6.01	30211506
UNSPSC 7.0901	39121008
UNSPSC 11	39121008
UNSPSC 12.01	39121008
UNSPSC 13.2	43222604
UNSPSC 18.0	43222604
UNSPSC 19.0	43222604
UNSPSC 20.0	43222604
UNSPSC 21.0	43222604

## Approvals

### Approvals

#### Approvals

DNV GL / UL Recognized / cUL Recognized / EAC / cULus Recognized

#### Ex Approvals

cUL Recognized / UL Listed / cUL Listed / cULus Listed

### Approval details

DNV GL		<a href="https://approvalfinder.dnvgl.com/">https://approvalfinder.dnvgl.com/</a>	TAA00001KR
--------	--	---	------------

UL Recognized		<a href="http://database.ul.com/cgi-bin/XYV/template/LISEXT/1FRAME/index.htm">http://database.ul.com/cgi-bin/XYV/template/LISEXT/1FRAME/index.htm</a>	FILE E 238705
---------------	--	---	---------------

cUL Recognized		<a href="http://database.ul.com/cgi-bin/XYV/template/LISEXT/1FRAME/index.htm">http://database.ul.com/cgi-bin/XYV/template/LISEXT/1FRAME/index.htm</a>	FILE E 238705
----------------	--	---	---------------

# Interface converter - PSM-ME-RS232/TTY-P - 2744458

## Approvals

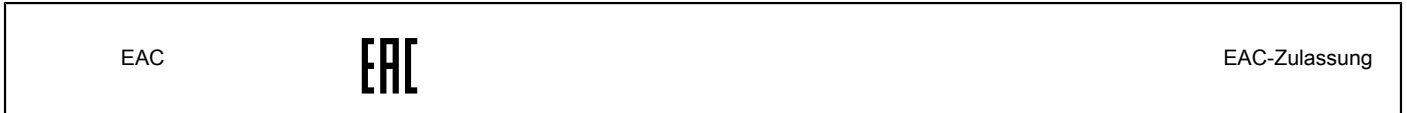

## Accessories

### Accessories

#### Adapter cable

Data cable - PSM-KA9SUB9/BB/2METER - 2799474



RS-232 cable, 9-pos. D-SUB socket on 9-pos. D-SUB socket, 9-wire, 1:1

#### Data plug

D-SUB bus connector - SUBCON 9/F-SH - 2761499



D-SUB plug, 9-pos. female connector, one cable entry < 35°, universal type for all systems, pin assignment: 1, 2, 3, 4, 5, 6, 7, 8, 9 to screw connection terminal block

#### Mounting material

Shield connection clamp - ME-SAS - 2853899



Shield connection clamp for printed circuit terminal block

#### Screwdriver tools

## Interface converter - PSM-ME-RS232/TTY-P - 2744458

### Accessories

Screwdriver - SZF 1-0,6X3,5 - 1204517



Actuation tool, for ST terminal blocks, also suitable for use as a bladed screwdriver, size: 0.6 x 3.5 x 100 mm, 2-component grip, with non-slip grip

---

Phoenix Contact 2020 © - all rights reserved  
<http://www.phoenixcontact.com>

PHOENIX CONTACT GmbH & Co. KG  
Flachsmarktstr. 8  
32825 Blomberg  
Germany  
Tel. +49 5235 300  
Fax +49 5235 3 41200  
<http://www.phoenixcontact.com>

## X-ON Electronics

Largest Supplier of Electrical and Electronic Components

*Click to view similar products for [Phoenix Contact](#) manufacturer:*

Other Similar products are found below :

[1203259](#) [1893300](#) [1212619](#) [1927221](#) [1936102](#) [1730573](#) [3240366](#) [3240367](#) [1014246](#) [1014236](#) [1014240](#) [1014290](#) [1014293](#) [1806193](#)  
[1823655](#) [1912825](#) [1842254](#) [1768260](#) [1716373](#) [1648030](#) [1579051](#) [1014235](#) [1014239](#) [1014229](#) [1212378](#) [2800744](#) [3006564](#) [2800741](#)  
[5146480](#) [1623633](#) [1507793](#) [3025587](#) [3069708](#) [1431461](#) [1586976](#) [0311647](#) [1460160](#) [1771338](#) [3048387](#) [2814605](#) [0309086](#) [1513716](#)  
[3035684](#) [5451417](#) [0202219](#) [1647747](#) [1730667](#) [1709267](#) [5449018](#) [0311634](#)